



Payment Status Report

Implementation Guidelines

Version 1.0

Table of Contents

| | | |
|----------|--|-----------|
| 1 | Introduction | 4 |
| 1.1 | Coverage | 5 |
| 1.2 | Use of these Guidelines | 6 |
| 1.3 | Character Set | 7 |
| 1.4 | Message structure | 7 |
| 2 | Payment Status Report..... | 10 |
| 2.1 | Message structure | 10 |
| 3 | Message items description | 13 |
| | Message root | 13 |
| 1.0 | GroupHeader | 13 |
| 1.1 | MessageIdentification | 14 |
| 1.2 | CreationDateTime..... | 14 |
| 1.3 | Initiatingparty | 15 |
| 2.0 | OriginalGroupInformationAndStatus | 16 |
| 2.1 | OriginalMessageIdentification..... | 16 |
| 2.2 | OriginalMessageNameIdentification | 17 |
| 2.6 | Groupstatus | 17 |
| 2.7 | StatusReasonInformation | 18 |
| 2.9 | Reason | 18 |
| 2.10 | Code..... | 19 |
| 2.12 | AdditionalInformation | 19 |
| 3.0 | OriginalPaymentInformationAndStatus | 20 |
| 3.1 | OriginalPaymentInformationIdentification | 21 |
| 3.2 | OriginalNumberOfTransactions | 21 |
| 3.3 | OriginalControlSum | 21 |
| 3.4 | PaymentInformationStatus | 22 |
| 3.5 | StatusReasonInformation | 23 |
| 3.7 | Reason | 23 |
| 3.8 | Code..... | 24 |
| 3.10 | AdditionalInformation | 24 |
| 3.11 | NumberOfTransactionsPerStatus | 25 |
| 3.12 | DetailedNumberOfTransactions | 25 |
| 3.13 | DetailedStatus..... | 26 |
| 3.14 | DetailedControlSum | 26 |
| 3.15 | TransactionInformationAndStatus | 27 |
| 3.16 | StatusIdentification..... | 27 |
| 3.17 | OriginalInstructionIdentification | 28 |
| 3.18 | OriginalEndToEndIdentification..... | 28 |

| | | |
|----------|---|-----------|
| 3.19 | TransactionStatus | 29 |
| 3.20 | StatusReasonInformation | 30 |
| 3.21 | Originator..... | 30 |
| 3.22 | Reason | 31 |
| 3.23 | Code | 31 |
| 3.25 | AdditionalInformation | 32 |
| 3.32 | OriginalTransactionReference | 33 |
| 3.34 | Amount | 34 |
| 3.35 | InstructedAmount..... | 35 |
| 3.36 | EquivalentAmount | 35 |
| 3.37 | Amount | 36 |
| 3.38 | CurrencyOfTransfer | 36 |
| 3.40 | RequestedCollectionDate | 37 |
| 3.41 | RequestedExecutionDate | 37 |
| 3.42 | CreditorSchemeIdentification..... | 38 |
| 3.55 | PaymentTypeInfoInformation..... | 39 |
| 3.58 | ServiceLevel | 39 |
| 3.59 | Code | 40 |
| 3.61 | LocalInstrument | 40 |
| 3.62 | Code | 41 |
| 3.64 | SequenceType..... | 41 |
| 3.69 | MandateRelatedInformation..... | 42 |
| 3.70 | MandateIdentification | 42 |
| 3.88 | RemittanceInformation | 43 |
| 3.89 | Unstructured..... | 43 |
| 3.90 | Structured | 44 |
| 3.110 | CreditorReferenceInformation | 44 |
| 3.111 | Type | 46 |
| 3.112 | CodeOrProprietary..... | 46 |
| 3.113 | Code..... | 47 |
| 3.115 | Issuer..... | 47 |
| 3.116 | Reference..... | 47 |
| 3.121 | Debtor | 48 |
| 3.122 | DebtorAccount..... | 48 |
| 3.123 | DebtorAgent | 49 |
| 3.125 | CreditorAgent | 50 |
| 3.127 | Creditor..... | 51 |
| 3.128 | CreditorAccount..... | 51 |
| 4 | Statuscodes | 52 |
| 5 | List of Status Reason codes..... | 53 |

1 Introduction

This document sets out the Belgian Implementation Guidelines for the XML Customer Payment Status Report message ISO 20022 XML - "pain.002.001.03".

The purpose of these Implementation Guidelines is to provide guidance on the use of the Payment Status Report Message sent by the banks to their customers.

These Implementation Guidelines have been developed by Febelfin (the Belgian Financial Sector Federation).

The utmost has been done to make sure the information in this publication is correct. However, Febelfin by no means can be held liable for any loss or damage incurred due to any incorrect or incomplete information mentioned in this publication.

This text is only available in English.

Please contact your bank for any further information.

1.1 Coverage

The CustomerPaymentStatusReport message is sent by an instructed agent to the previous party in the payment chain. It is used to inform this party about the positive or negative status of a file (Reporting on GroupHeader) or a negative status of a complete PaymentInformationblock or a transaction. It is also used to report on a pending instruction.

The CustomerPaymentStatusReport message is exchanged between an agent and a non-financial institution customer to provide status information on instructions previously sent. Its usage will always be governed by a bilateral agreement between the agent and the non-financial institution customer.

The CustomerPaymentStatusReport message can be used to provide information about the status (e.g. rejection, acceptance) of the initiation of a credit transfer (SEPA or generic) or a direct debit.

The CustomerPaymentStatusReport message refers to the original instruction(s) by means of references only or by means of references and a set of elements from the original instruction.

The CustomerPaymentStatusReport message can be used in domestic and cross-border scenarios.

1.2 Use of these Guidelines

Each item of the CreditTransferStatusReport message is referring to the corresponding index of the item in the XML(ISO 20022) Message Definition Report for Payment Standards – Status Report. This Report can be found on www.iso20022.org, under “Catalogue of XML messages”, with “pain.002.001.03” as reference.

Any gaps in the index numbering are due to the fact that some message elements of the XML message are not supported. The occurrences of a message element (mandatory/optional) can also show a difference between these guidelines and the ISO 20022 XML Message Definition.

The description of each message item contains:

| | |
|-------------|---|
| Index | Number referring to the corresponding description in the ISO 20022 XML Message Definition Report for Payment Standards – Payments Status Report |
| Definition | This contains the definition of the message set or element |
| Usage | Additional info on how this element must be used |
| XML Tag | Short name identifying an element within an XML message, which is put between brackets, e.g. <Amt> |
| Occurrences | <p>This indicates whether an element is optional or mandatory and how many times the element can be repeated. The number of occurrences is shown between square brackets</p> <p>For example:</p> <p>[0..1] shows that the element can be present 0 times or 1 time. The element is optional</p> <p>[1..1] shows that the element can be present only 1 time. The element is mandatory</p> <p>[1..n] shows that the element is mandatory and can be present 1 to n times</p> <p>An element which is part of a set of elements, is mandatory as far as the set it is part of, is present in the message.</p> <p>If only one of several elements may be present, this is indicated by {OR ... OR} in front of the elements concerned</p> |
| Format | <p>This specifies the values and format allowed</p> <p>Remark: if a tag is used, the correspondent data field may not be left empty. At least one character has to be filled in.</p> |
| Rules | Any specific rules which could have an impact on the presence or the values of an element |

1.3 Character Set

The UTF8 character encoding standard must be used in the XML messages.

The Latin character set, commonly used in international communication, must be used.

It contains the following characters:

a b c d e f g h i j k l m n o p q r s t u v w x y z

A B C D E F G H I J K L M N O P Q R S T U V W X Y Z

0 1 2 3 4 5 6 7 8 9

/ - ? : () . , ' +

Space

1.4 Message structure

The description of the XML document models can be found in a number of schemes. A specific description language (XSD) is used in those schemes. The schemes make it possible to give a description of the tags in the document, the structure and sequence of those beacons (hierarchy of tags) as well as the codes which are allowed for some specific data, the number of possible cases, the obligatory or optional character of some of the data, etc.

The general XSD for pain.002.001.03 can be downloaded from www.iso20022.org > Catalogue of ISO 20022 Messages > Payments > Payments Initiation > CustomerCreditTransferStatus ReportV03

A file containing an XML- pain.002.001.03 message has the following structure:

```
<?xml version="1.0" encoding="UTF-8"?>
<Document xmlns="urn:iso:std:iso:20022:tech:xsd:pain.002.001.03"
xmlns:xsi="http://www.w3.org/2001/XMLSchema-instance">
  <CstmrPmtStsRpt>
    message content...
  </CstmrPmtStsRpt>
</Document>
```

A file must contain one single Document (envelope), with one single XML message in it.

The message consists of 3 building blocks:

A. Group Header

This building block is mandatory and present once. It contains elements such as MessageIdentification, CreationDateAndTime.

B. Original Group Information and Status

This building block is mandatory and present once. It contains elements such as OriginalMessageIdentification, OriginalMessageNameIdentification, GroupStatus.

C. Original Payment Information And Status

This building block is optional and repetitive. It contains elements referencing the original instruction (for example OriginalEndToEndIdentification), elements relating to the CustomerPaymentStatusReport (for example StatusReasonInformation). The OriginalPaymentInformationAndStatus block may also transport a set of elements from the original instruction.

The figure below shows the structure of a Payment Status Report Message more into detail.

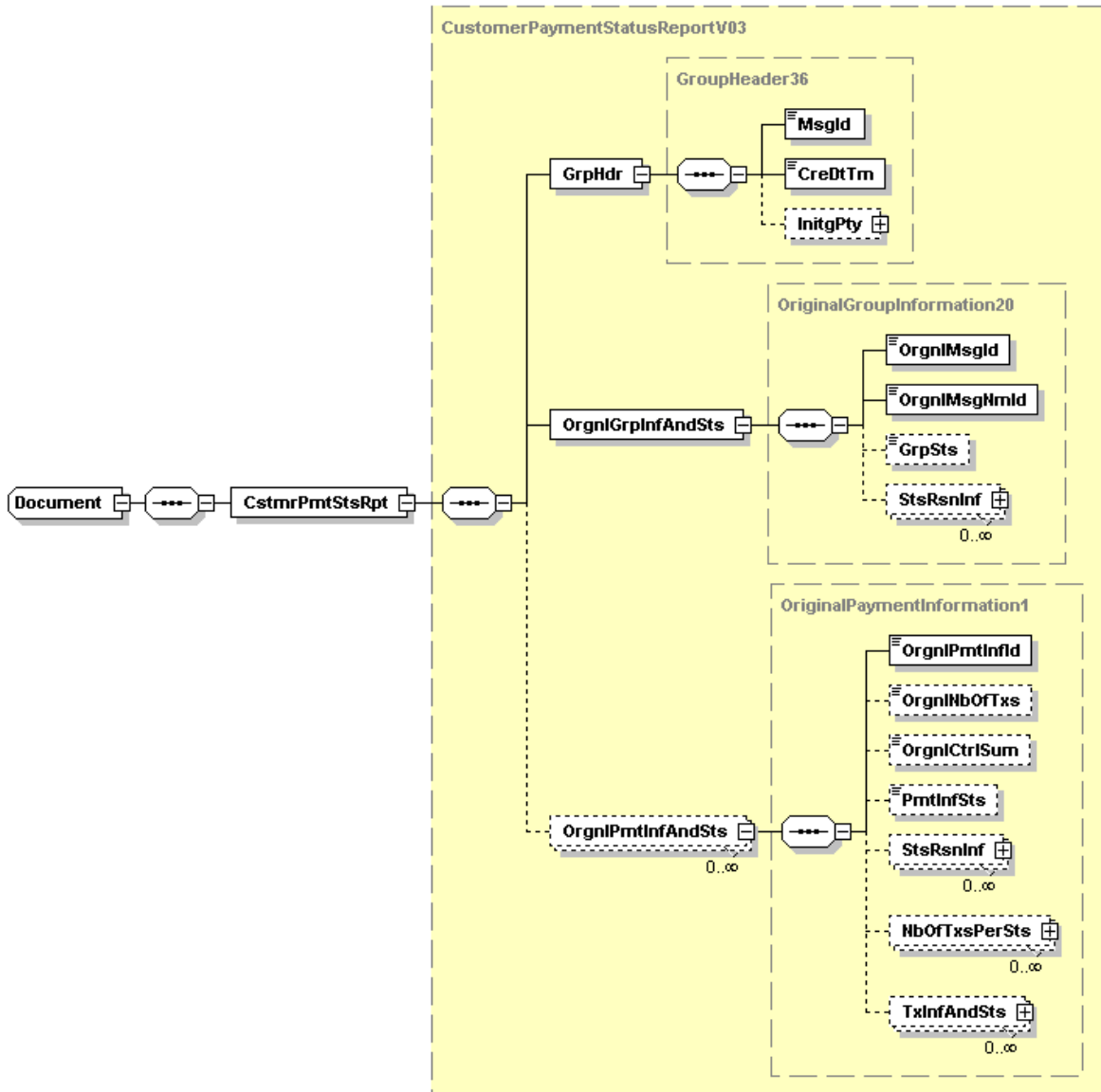

Legend:

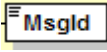
 Box with full-line is a **mandatory** Message Element

 Box with dotted line is an **optional** Message Element

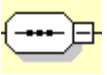
 The Child Elements must appear in the **sequence** mentioned

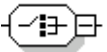
 Only one of the possible Child Elements may be present (choice)

2 Payment Status Report

2.1 Message structure

The following table gives a summary of the message items to be used for a **Payment Status Report**. A more detailed description of each message item is given in chapter 3 "Message items description"

| | | | | |
|------|--------|--|---|---------------------|
| | [1..1] | | + Message root | <CstmrPmtStsRpt> |
| 1.0 | [1..1] | | + GroupHeader | <GrpHdr> |
| 1.1 | [1..1] | | ++ MessageIdentification | <MsgId> |
| 1.2 | [1..1] | | ++ CreationDateTime | <CreDtTm> |
| 1.3 | [0..1] | | ++ InitiatingParty | <InitgPty> |
| | [0..1] | | +++ Identification | <Id> |
| | [1..1] | | ++++ OrganisationIdentification | <OrgId> |
| | [0..1] | | +++++ BICOrBEI | <BICOrBEI> |
| 2.0 | [1..1] | | + OriginalGroupInformationAndStatus | <OrgnlGrpInfAndSts> |
| 2.1 | [1..1] | | ++ OriginalMessageIdentification | <OrgnlMsgId> |
| 2.2 | [1..1] | | ++ OriginalMessageNameIdentification | <OrgnlMsgNmId> |
| 2.6 | [0..1] | | ++ GroupStatus | <GrpSts> |
| 2.7 | [0..n] | | ++ StatusReasonInformation | <StsRsnInf> |
| 2.9 | [0..1] | | +++ Reason | <Rsn> |
| 2.10 | [1..1] | | ++++ Code | <Cd> |
| 2.12 | [0..n] | | +++ AdditionalInformation | <AddtlInf> |
| 3.0 | [0..n] | | + OriginalPaymentInformationAndStatus | <OrgnlPmtInfAndSts> |
| 3.1 | [1..1] | | ++ OriginalPaymentInformationIdentification | <OrgnlPmtInfId> |
| 3.2 | [0..1] | | ++ OriginalNumberOfTransactions | <OrgnlNbOfTx> |
| 3.3 | [0..1] | | ++ OriginalControlSum | <OrgnlCtrlSum> |
| 3.4 | [0..1] | | ++ PaymentInformationStatus | <PmtInfSts> |
| 3.5 | [0..n] | | ++ StatusReasonInformation | <StsRsnInf> |
| 3.7 | [0..1] | | +++ Reason | <Rsn> |
| 3.8 | [1..1] | | ++++ Code | <Cd> |
| 3.10 | [0..n] | | +++ AdditionalInformation | <AddtlInf> |
| 3.11 | [0..n] | | ++ NumberOfTransactionsPerStatus | <NbOfTxPerSts> |
| 3.12 | [1..1] | | +++ DetailedNumberOfTransactions | <DtldNbOfTx> |
| 3.13 | [1..1] | | +++ DetailedStatus | <DtldSts> |
| 3.14 | [0..1] | | +++ DetailedControlSum | <DtldCtrlSum> |
| 3.15 | [0..n] | | ++ TransactionInformationAndStatus | <TxInfAndSts> |
| 3.16 | [0..1] | | +++ StatusIdentification | <StsId> |
| 3.17 | [0..1] | | +++ OriginalInstructionIdentification | <OrgnlInstrId> |
| 3.18 | [0..1] | | +++ OriginalEndToEndIdentification | <OrgnlEndToEndId> |
| 3.19 | [0..1] | | +++ TransactionStatus | <TxSts> |
| 3.20 | [0..n] | | +++ StatusReasonInformation | <StsRsnInf> |
| 3.21 | [0..1] | | ++++ Originator | <Orgtr> |
| 3.22 | [0..1] | | ++++ Reason | <Rsn> |
| 3.23 | [1..1] | | +++++ Code | <Cd> |
| 3.25 | [0..n] | | ++++ AdditionalInformation | <AddtlInf> |
| 3.32 | [0..1] | | +++ OriginalTransactionReference | <OrgnlTxRef> |

| | | | | |
|-------|--------|-----|--|----------------------|
| 3.34 | [0..1] | | ++++ Amount | <Amt> |
| 3.35 | [1..1] | {Or | +++++ InstructedAmount | <InstdAmt Ccy="AAA"> |
| 3.36 | [1..1] | Or} | +++++ EquivalentAmount | <EqvtAmt> |
| 3.37 | [1..1] | | ++++++ Amount | <Amt Ccy="AAA"> |
| 3.38 | [1..1] | | ++++++ CurrencyOfTransfer | <CcyOfTrf> |
| 3.40 | [0..1] | | ++++ RequestedCollectionDate | <ReqdColltnDt> |
| 3.41 | [0..1] | | ++++ RequestedExecutionDate | <ReqdExctnDt> |
| 3.42 | [0..1] | | ++++ CreditorSchemeIdentification | <CdtrSchmId> |
| 3.55 | [0..1] | | ++++ PaymentTypeInfoInformation | <PmtTpInf> |
| 3.58 | [0..1] | | +++++ Service Level | <SvcLvl> |
| 3.59 | [1..1] | | ++++++ Code | <Cd> |
| 3.61 | [0..1] | | +++++ Local Instrument | <LclInstrm> |
| 3.62 | [1..1] | | ++++++ Code | <Cd> |
| 3.64 | [0..1] | | +++++ SequenceType | <SeqTp> |
| 3.69 | [0..1] | | ++++ MandateRelatedInformation | <MndtRltdInf> |
| 3.70 | [0..1] | | +++++ MandateIdentification | <MndtId> |
| 3.88 | [0..1] | | ++++ RemittanceInformation | <RmtInf> |
| 3.89 | [0..1] | | +++++ Unstructured | <Ustrd> |
| 3.90 | [0..1] | | +++++ Structured | <Strd> |
| 3.110 | [0..1] | | ++++++ CreditorReferenceInformation | <CdtrRefInf> |
| 3.111 | [0..1] | | +++++++ Type | <Tp> |
| 3.112 | [1..1] | | +++++++ CodeOrProprietary | <CdOrPrtry> |
| 3.113 | [1..1] | | +++++++ Code | <Cd> |
| 3.115 | [0..1] | | +++++++ Issuer | <Issr> |
| 3.116 | [0..1] | | +++++ Reference | <Ref> |
| 3.121 | [0..1] | | ++++ Debtor | <Dbtr> |
| | [0..1] | | +++++ Name | <Nm> |
| 3.122 | [0..1] | | ++++ DebtorAccount | <DbtrAcct> |
| | [1..1] | | +++++ Identification | <Id> |
| | [1..1] | {Or | +++++ IBAN | <IBAN> |
| | [1..1] | Or} | +++++ Other | <Othr> |
| | [1..1] | | +++++++ Identification | <Id> |
| | [0..1] | | +++++ Currency | <Ccy> |
| 3.123 | [0..1] | | ++++ DebtorAgent | <DbtrAgt> |
| | [1..1] | | +++++ FinancialInstitutionIdentification | <FinInstnId> |
| | [0..1] | | +++++ BIC | <BIC> |
| 3.125 | [0..1] | | ++++ CreditorAgent | <CdtrAgt> |
| | [1..1] | | +++++ FinancialInstitutionIdentification | <FinInstnId> |
| | [0..1] | | +++++ BIC | <BIC> |
| | [0..1] | | +++++ ClearingSystemMemberIdentification | <ClrSysMmbId> |
| | [0..1] | | +++++ ClearingSystemIdentification | <ClrSysId> |
| | [1..1] | | +++++++ Code | <Cd> |
| | [1..1] | | +++++++ MemberIdentification | <MmbId> |
| | [0..1] | | +++++++ Name | <Nm> |
| | [0..1] | | +++++ PostalAddress | <PstlAdr> |
| | [0..1] | | +++++++ Country | <Ctry> |
| | [0..2] | | +++++++ AddressLine | <AdrLine> |
| 3.127 | [0..1] | | ++++ Creditor | <Cdtr> |
| | [0..1] | | +++++ Name | <Nm> |

| | | | | |
|-------|--------|-----|------------------------|------------|
| 3.128 | [0..1] | | ++++ CreditorAccount | <CdtrAcct> |
| | 1..1 | | +++++ Identification | <Id> |
| | 1..1 | {Or | +++++++ IBAN | <IBAN> |
| | 1..1 | Or} | +++++++ Other | <Othr> |
| | 1..1 | | +++++++ Identification | <Id> |

3 Message items description

Message root

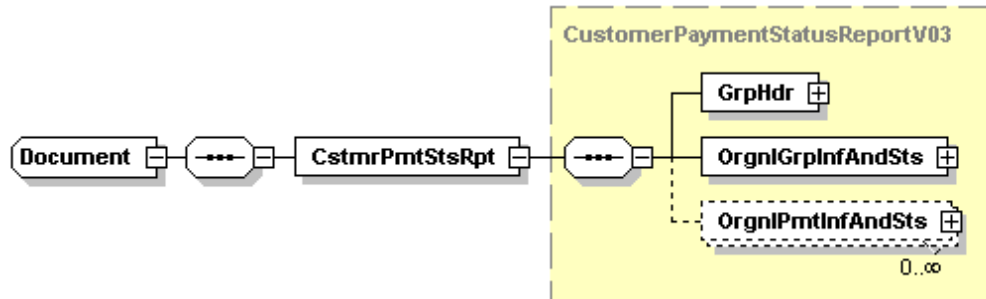

XML Tag: <CstmrPmtStsRpt>

Occurrence: [1..1]

1.0 GroupHeader

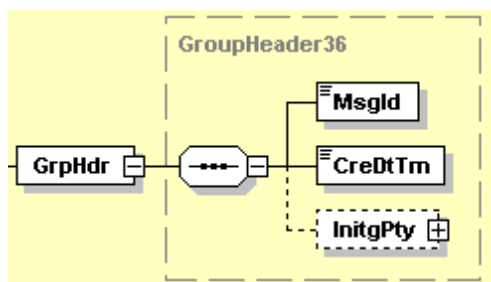

Definition: Set of characteristics shared by all individual transactions included in the status report message.

XML Tag: <GrpHdr>

Occurrences: [1..1]

Format: /

Rules: /

1.1 MessageIdentification

MsgId

Definition: Point to point reference, as assigned by the instructing party, and sent to the next party in the chain to unambiguously identify the message.

Usage: The instructing party has to make sure that 'MessageIdentification' is unique per instructed party for a pre-agreed period.

XML Tag: <MsgId>

Occurrences: [1..1]

Format: Max35Text

Rules: /

1.2 CreationDateTime

CreDtTm

Definition: Date and time at which the message was created.

XML Tag: <CreDtTm>

Occurrences: [1..1]

Format: ISODateTime

Rules: /

1.3 Initiatingparty

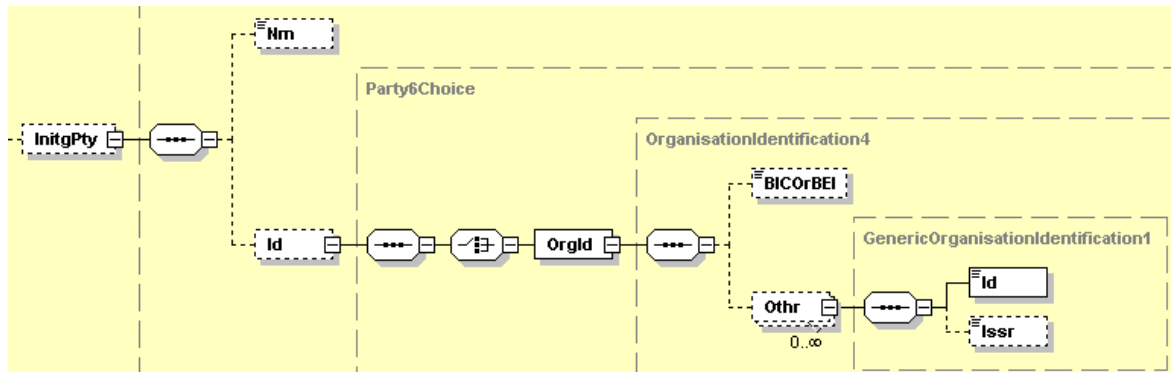

Definition: Party that initiates the status message.

XML Tag: <InitgPty>

Occurrences: [0..1]

Format: The message item consists of the following elements:

| Name | XML Tag | Occ. |
|----------------------------|------------|--------|
| Name | <Nm> | [0..1] |
| Identification | <Id> | [0..1] |
| OrganisationIdentification | <OrgId> | [1..1] |
| BICOrBEI | <BICOrBEI> | [0..1] |
| Other | <Othr> | [0..n] |
| Identification | <Id> | [1..1] |
| Issuer | <Issr> | [0..1] |

Rules: Either Name or Identification or both can be used.
Name is limited to 70 characters.

2.0 OriginalGroupInformationAndStatus

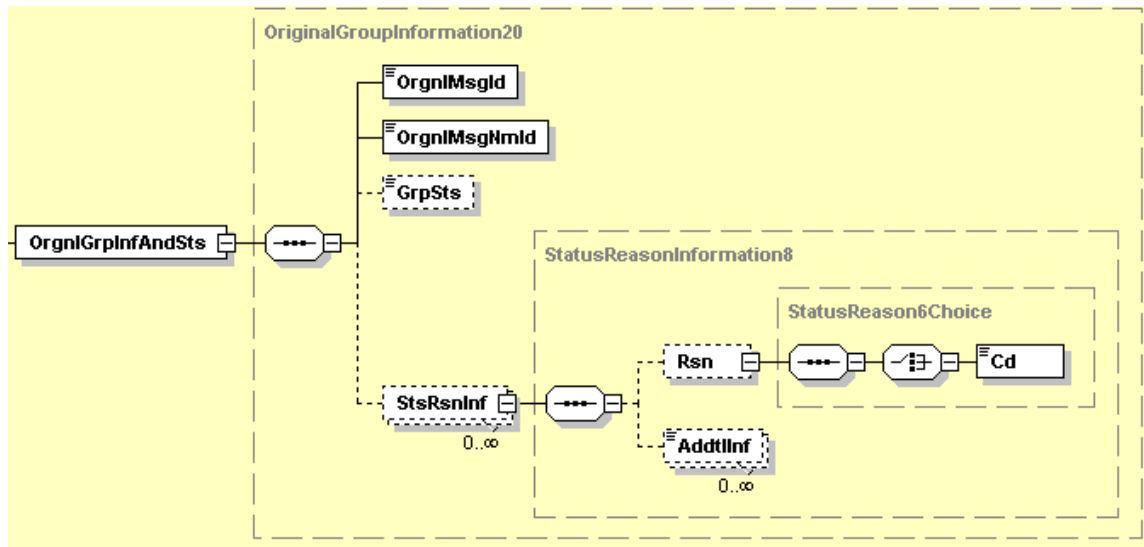

Definition: Original group information concerning the group of transactions, to which the status report message refers to.

XML Tag: <OrgnlGrpInfAndSts>

Occurrences: [1..1]

Format: /

Rules: If GroupStatus is present and is different from RJCT or PDNG then StatusReasonInformation/AdditionalInformation must be absent.

2.1 OriginalMessageIdentification



Definition: Point to point reference, as assigned by the original instructing party, to unambiguously identify the original message.

XML Tag: <OrgnlMsgId>

Occurrences: [1..1]

Format: Max35Text

Rules: /

2.2 OriginalMessageNameIdentification

OrgnlMsgNmId

Definition: Specifies the original message name identifier to which the message refers.

XML Tag: <OrgnlMsgNmId>

Occurrences: [1..1]

Format: Max35Text

Rules: /

2.6 Groupstatus

GrpSts

Definition: Specifies the status of a group of transactions.

XML Tag: <GrpSts>

Occurrences: [0..1]

Format: One of the following codes can be used:

| Code | Name | Definition |
|------|-----------------------------|---|
| ACCP | AcceptedCustomerProfile | Preceding check of technical validation was successful. Customer profile check was also successful. |
| ACTC | AcceptedTechnicalValidation | Authentication and syntactical and semantical validation are successful. |
| ACWC | AcceptedWithChange | Instruction is accepted but a change will be made, such as date or remittance not sent. |
| PART | PartiallyAccepted | A number of transactions have been accepted, whereas another number of transactions have not yet achieved 'accepted' status. |
| PDNG | Pending | Payment initiation or individual transaction included in the payment initiation is pending. Further checks and status update will be performed. |
| RCVD | Received | Payment initiation has been received by the receiving agent. |
| RJCT | Rejected | Payment initiation or individual transaction included in the payment initiation has been rejected. |

This is a list of most used codes. For the complete list see [4 StatusCodes](#)

Rules: /

2.7 StatusReasonInformation

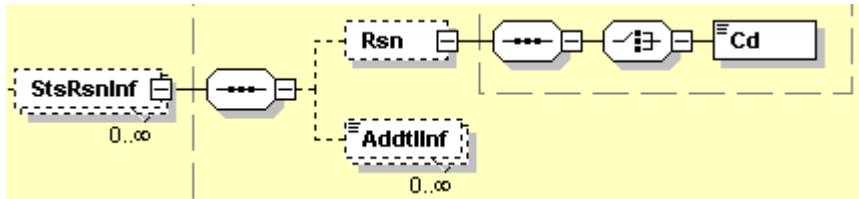

Definition: Set of elements used to provide detailed information on the status reason.

XML Tag: <StsRsnInf>

Occurrences: [0..n]

Format: /

Rules: 'Status Reason Information' may be present in 'Original Group Information And Status', 'Original Payment Information Status' or 'Transaction Information and Status'.

StatusReasonRule:

If Reason/Code is equal to NARR, then AdditionalInformation must be present.

2.9 Reason

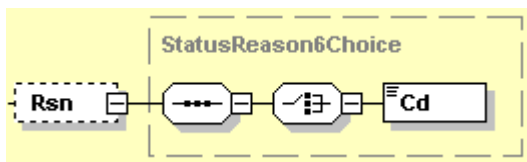

Definition: Specifies the reason for the status report.

XML Tag: <Rsn>

Occurrences: [0..1]

Format: This message contains the following element:

| Index | Name | XML Tag |
|-------|------|---------|
| 2.10 | Code | <Cd> |

Rules: /

2.10 Code

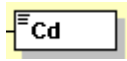

This message item is part of choice 2.9 Reason.

Definition: Reason for the status, as published in an external reason code list.
[See 5 List Of Status Reason Codes](#) in this document or [External Reason Code List](#) on the ISO20022 website.

XML Tag: <Cd>

Occurrences: [1..1]

Format:

Rules: /

2.12 AdditionalInformation



Definition: Further details on the status reason.

XML Tag: <AddtlInf>

Occurrences: [0..n]

Format: maxLength: 105

Rules: Additional information can be used for several purposes such as the reporting of repaired information.
If Reason/Code is equal to NARR, then AdditionalInformation must be present.

3.0 OriginalPaymentInformationAndStatus

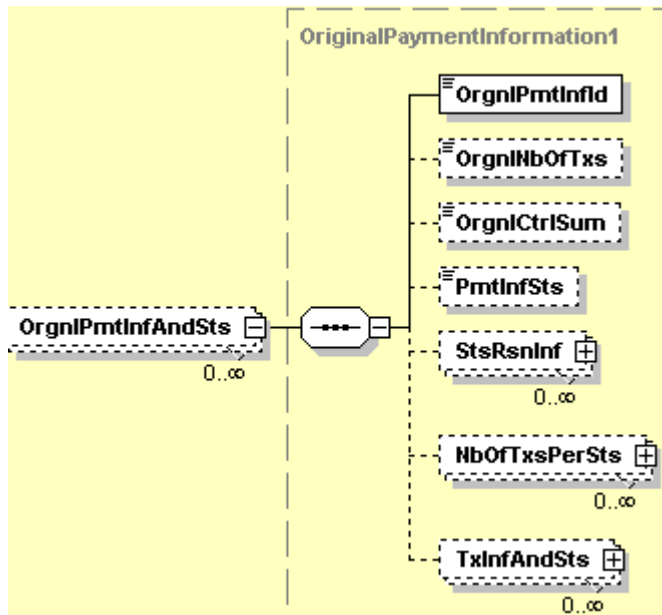

Definition: Information concerning the original payment information, to which the status report message refers.

XML Tag: <OrgnlPmtInfAndSts>

Occurrences: [0..n]

Format: /

Rules: PaymentInformationStatusAcceptedRule

If OriginalPaymentInformationAndStatus/PaymentInformationStatus is present and is equal to ACTC, ACCP, ACSP, ACSC or ACWC, then TransactionInformationAndStatus/TransactionStatus must be different from RJCT.

PaymentInformationStatusPendingRule

If OriginalPaymentInformationAndStatus/PaymentInformationStatus is present and is equal to PDNG, then TransactionInformationAndStatus/TransactionStatus must be different from RJCT.

PaymentInformationStatusReceivedRule

If OriginalPaymentInformationAndStatus/PaymentInformationStatus is present and is equal to RCVD, then TransactionInformationAndStatus/TransactionStatus is not allowed.

PaymentInformationStatusRejectedRule

If OriginalPaymentInformationAndStatus/PaymentInformationStatus is present and is equal to RJCT, then TransactionInformationAndStatus/TransactionStatus, if present, must be equal to RJCT.

3.1 OriginalPaymentInformationIdentification

 **OrgnlPmtInfId**

Definition: Unique identification, as assigned by the original sending party, to unambiguously identify the original payment information group.

XML Tag: <OrgnlPmtInfId>

Occurrences: [1..1]

Format: Max35Text

Rules: /

3.2 OriginalNumberOfTransactions

 **OrgnlNbOfTx**

Definition: Number of individual transactions contained in the original payment information group.

XML Tag: <OrgnlNbOfTx>

Occurrences: [0..1]

Format: Min 1, Max 15 Digits

Rules: /

3.3 OriginalControlSum

 **OrgnlCtrlSum**

Definition: Total of all individual amounts included in the original payment information group, irrespective of currencies.

XML Tag: <OrgnlCtrlSum>

Occurrences: [0..1]

Format: fractionDigits: 17
totalDigits: 18

Rules: /

3.4 PaymentInformationStatus



Definition: Specifies the status of the payment information group.

XML Tag: <PmtInfSts>

Occurrences: [0..1]

Format: When this message item is present, one of the following values must be used:

| Code | Name | Definition |
|------|-----------------------------|---|
| ACCP | AcceptedCustomerProfile | Preceding check of technical validation was successful. Customer profile check was also successful. |
| ACTC | AcceptedTechnicalValidation | Authentication and syntactical and semantical validation are successful. |
| ACWC | AcceptedWithChange | Instruction is accepted but a change will be made, such as date or remittance not sent. |
| PART | PartiallyAccepted | A number of transactions have been accepted, whereas another number of transactions have not yet achieved 'accepted' status. |
| PDNG | Pending | Payment initiation or individual transaction included in the payment initiation is pending. Further checks and status update will be performed. |
| RCVD | Received | Payment initiation has been received by the receiving agent. |
| RJCT | Rejected | Payment initiation or individual transaction included in the payment initiation has been rejected. |

This is a list of most used codes. For the complete list see [4 StatusCodes](#)

Rules: /

3.5 StatusReasonInformation

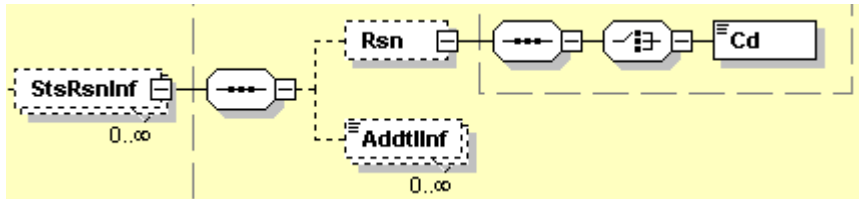

Definition: Set of elements used to provide detailed information on the status reason.

XML Tag: <StsRsnInf>

Occurrences: [0..n]

Format: This message item is composed of the following element:

| Index | Name | XML Tag | Occ. |
|-------|--------|---------|--------|
| 3.7 | Reason | <Rsn> | [0..1] |

Rules: 'Status Reason Information' may be present in 'Original Group Information And Status', 'Original Payment Information Status' or 'Transaction Information and Status'.

StatusReasonRule

If Reason/Code is equal to NARR, then AdditionalInformation must be present.

3.7 Reason

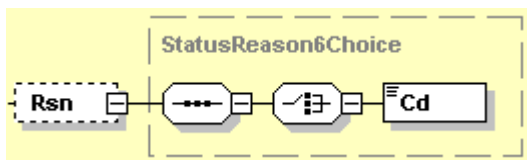

Definition: Specifies the reason for the status report.

XML Tag: <Rsn>

Occurrences: [0..1]

Format: This message item is composed of the following element:

| Index | Name | XML Tag |
|-------|------|---------|
| 3.8 | Code | <Cd> |

Rules: /

3.8 Code

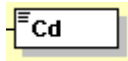

Definition: Reason for the status, as published in an external reason code list. [See 5 List Of Status Reason Codes](#) in this document or [External Reason Code List](#) on the ISO20022 website.

XML Tag: <Cd>

Occurrences: [1..1]

Format: /

Rules: /

3.10 AdditionalInformation



Definition: Further details on the status reason.

XML Tag: <AddtlInf>

Occurrences: [0..n]

Format: maxLength: 105

Rules: Additional information can be used for several purposes such as the reporting of repaired information.
StatusReasonRule

If Reason/Code is equal to NARR, then AdditionalInformation must be present.

3.11 NumberOfTransactionsPerStatus

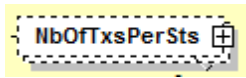

Definition: Detailed information on the number of transactions for each identical transaction status.

XML Tag: <NbOfTxPerSts>

Occurrences: [0..n]

Format: This message item is composed of the following element(s):

| Index | Message Item | <XML Tag> | Mult. |
|-------|------------------------------|---------------|--------|
| 3.12 | DetailedNumberOfTransactions | <DtldNbOfTx> | [1..1] |
| 3.13 | DetailedStatus | <DtldSts> | [1..1] |
| 3.14 | DetailedControlSum | <DtldCtrlSum> | [0..1] |

Rules: /

3.12 DetailedNumberOfTransactions

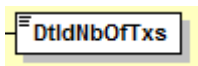

Definition: Number of individual transactions contained in the message, detailed per status.

XML Tag: <DtldNbOfTx>

Occurrences: [1..1]

Format: Max15NumericText

Rules: /

3.13 DetailedStatus

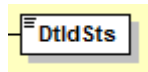

Definition: Common transaction status for all individual transactions reported.

XML Tag: <DtlDSts>

Occurrences: [1..1]

Format: One of the following values must be used:

| Code | Name | Definition |
|------|-----------------------------|---|
| ACCP | AcceptedCustomerProfile | Preceding check of technical validation was successful. Customer profile check was also successful. |
| ACTC | AcceptedTechnicalValidation | Authentication and syntactical and semantical validation are successful. |
| ACWC | AcceptedWithChange | Instruction is accepted but a change will be made, such as date or remittance not sent. |
| PDNG | Pending | Payment initiation or individual transaction included in the payment initiation is pending. Further checks and status update will be performed. |
| RJCT | Rejected | Payment initiation or individual transaction included in the payment initiation has been rejected. |

This is a list of most used codes. For the complete list see [4 StatusCodes](#)

Rules: /

3.14 DetailedControlSum

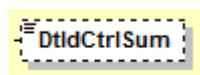

Definition: Total of all individual amounts included in the message, irrespective of currencies, detailed per status.

XML Tag: <DtlDCtrlSum>

Occurrences: [0..1]

Format: fractionDigits: 17
totalDigits: 18

Rules: /

3.15 TransactionInformationAndStatus

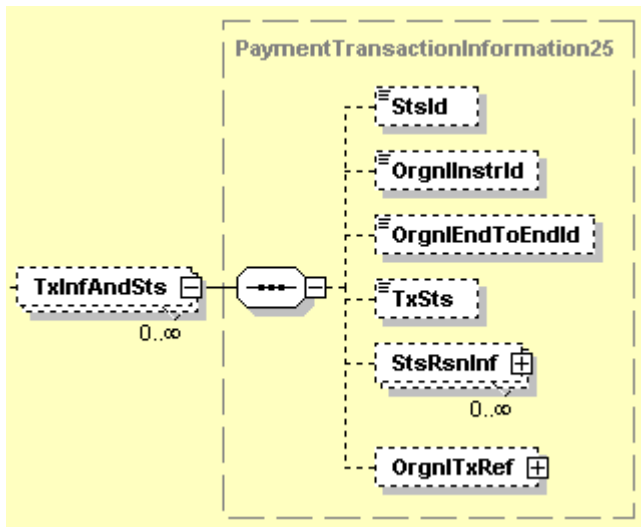

Definition: Set of elements used to provide information on the original transactions to which the status report message refers.

XML Tag: <TxInfAndSts>

Occurrences: [0..n]

Format: /

Rules: /

3.16 StatusIdentification



Definition: Unique identification, as assigned by an instructing party for an instructed party, to unambiguously identify the reported status.

Usage: The instructing party is the party sending the status message and not the party that sent the original instruction that is being reported on.

XML Tag: <StsId>

Occurrences: [0..1]

Format: Max35Text

Rules: /

3.17 OriginalInstructionIdentification

OrgnlInstrId

Definition: Unique identification, as assigned by the original instructing party for the original instructed party, to unambiguously identify the original instruction.

XML Tag: <OrgnlInstrId>

Occurrences: [0..1]

Format: Max35Text

Rules: /

3.18 OriginalEndToEndIdentification

OrgnlEndToEndId

Definition: Unique identification, as assigned by the original initiating party, to unambiguously identify the original transaction.

XML Tag: <OrgnlEndToEndId>

Occurrences: [0..1]

Format: Max35Text

Rules: /

3.19 TransactionStatus

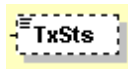

Definition: Specifies the status of a transaction, in a coded form.

XML Tag: <TxSts>

Occurrences: [0..1]

Format: Code

| Code | Name | Definition |
|------|-----------------------------|---|
| ACCP | AcceptedCustomerProfile | Preceding check of technical validation was successful. Customer profile check was also successful. |
| ACTC | AcceptedTechnicalValidation | Authentication and syntactical and semantical validation are successful. |
| ACWC | AcceptedWithChange | Instruction is accepted but a change will be made, such as date or remittance not sent. |
| PDNG | Pending | Payment initiation or individual transaction included in the payment initiation is pending. Further checks and status update will be performed. |
| RJCT | Rejected | Payment initiation or individual transaction included in the payment initiation has been rejected. |

This is a list of most used codes. For the complete list see [4 StatusCodes](#)

Rules: /

3.20 StatusReasonInformation

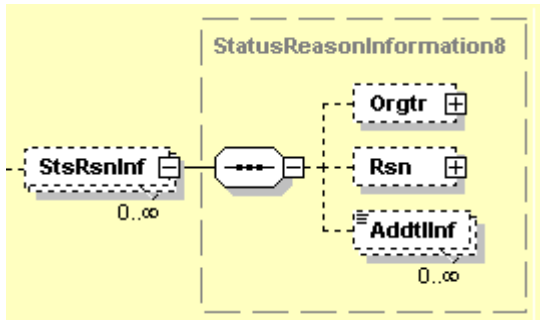

Definition: Set of elements used to provide detailed information on the status reason.

XML Tag: <StsRsnInf>

Occurrences: [0..n]

Format: This message item is composed of the following element:

| Index | Name | XML Tag |
|-------|--------|---------|
| 3.22 | Reason | <Rsn> |

Rules: Usage Rule: 'Status Reason Information' may be present in 'Original Group Information And Status', 'Original Payment Information Status' or 'Transaction Information and Status'.StatusReasonRule.
If Reason/Code is equal to NARR, then AdditionalInformation must be present.

3.21 Originator

Definition: Party that issues the status.

XML Tag: <Orgtr>

Occurrences: [0..1]

Format: This message item is composed of the following element:

| Index | Name | <XML Tag> |
|-------|------|-----------|
| | Name | <Nm> |

Rules: /

3.22 Reason

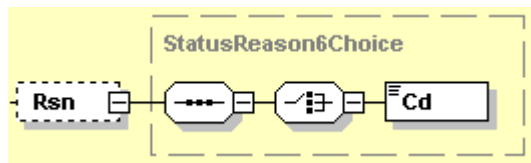

Definition: Specifies the reason for the status report.

XML Tag: `<Rsn>`

Occurrences: [0..1]

Format: This message item is composed of the following element:

| Index | Name | XML Tag |
|-------|------|-------------------------|
| 3.23 | Code | <code><Cd></code> |

Rules: /

3.23 Code



Definition: Reason for the status, as published in an external reason code list.
[See 5 List Of Status Reason Codes](#) in this document or [External Reason Code List](#) on the ISO20022 website.

XML Tag: `<Cd>`

Occurrences : [1..1]

Format: /

Rules: /

3.25 AdditionalInformation



Definition: Further details on the status reason.

XML Tag: <AddtlInf>

Occurrences: [0..n]

Format: maxLength: 105

Rules: Additional information can be used for several purposes such as the reporting of repaired information.
Usage: If Reason/Code is equal to NARR, then AdditionalInformation must be present.

3.32 OriginalTransactionReference

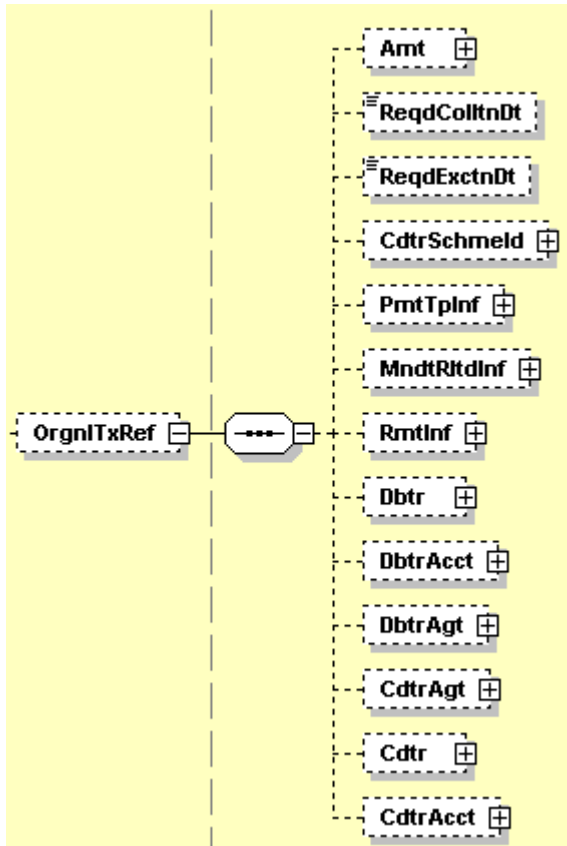

Definition: Set of key elements used to identify the original transaction that is being referred to.

XML Tag: <OrgnlTxRef>

Occurrences: [0..1]

Format: This message item is composed of the following element(s):

| Index | Name | XML Tag | Occ. |
|-------|------------------------------|----------------|--------|
| 3.34 | Amount | <Amt> | [0..1] |
| 3.40 | RequestedCollectionDate | <ReqdColltnDt> | [0..1] |
| 3.41 | RequestedExecutionDate | <ReqdExctnDt> | [0..1] |
| 3.42 | CreditorSchemeIdentification | <CdtrSchmeId> | [0..1] |
| 3.55 | PaymentTypeInformation | <PmtTpInf> | [0..1] |
| 3.69 | MandateRelatedInformation | <MndtRltdInf> | [0..1] |
| 3.88 | RemittanceInformation | <RmtInf> | [0..1] |
| 3.121 | Debtor | <Dbtr> | [0..1] |
| 3.122 | DebtorAccount | <DbtrAcct> | [0..1] |
| 3.123 | DebtorAgent | <DbtrAgt> | [0..1] |
| 3.125 | CreditorAgent | <CdtrAgt> | [0..1] |

| | | | |
|-------|-----------------|------------|--------|
| 3.127 | Creditor | <Cdtr> | [0..1] |
| 3.128 | CreditorAccount | <CdtrAcct> | [0..1] |

Rules: /

3.34 Amount

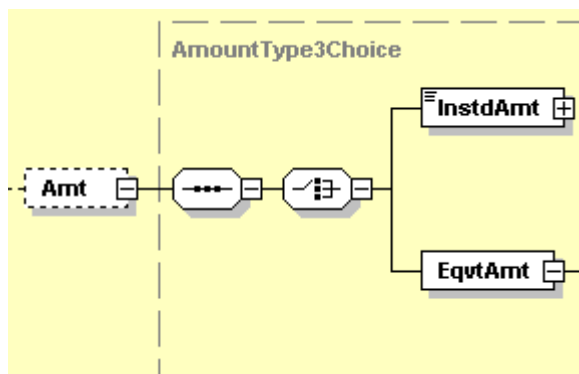

Definition: Amount of money to be moved between the debtor and creditor, before deduction of charges, expressed in the currency as ordered by the initiating party.

XML Tag: <Amt>

Occurrences: [0..1]

Format: This message item is composed of one of the following elements:

| Index | Name | Tag Name | Occ. |
|-------|------------------|------------|--------|
| 3.35 | InstructedAmount | <InstdAmt> | [1..1] |
| 3.36 | EquivalentAmount | <EqvtAmt> | [1..1] |

Rules: /

3.35 InstructedAmount



This message item is part of choice 3.34 Amount.

Definition: Amount of money to be moved between the debtor and creditor, before deduction of charges, expressed in the currency as ordered by the initiating party.

XML Tag: <InstdAmt>

Occurrences: [1..1]

Format: Maximum 11 digits for European Credit Transfers, two of which for the fractional part and excluding the decimal separator. E.g.: 999999999.99

Maximum 15 digits for other Credit Transfers, two of which for the fractional part and including the decimal separator. E.g.: 999999999999.99

Decimal separator is "."

Currency is explicit and included into the XML-tag.

Rules: /

3.36 EquivalentAmount

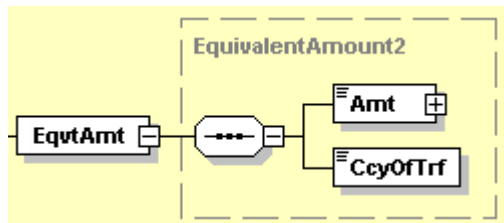

Definition: Amount of money to be moved between the debtor and creditor, expressed in the currency of the debtor's account, and the currency in which the amount is to be moved.

XML Tag: <EqvtAmt>

Occurrences: [1..1]

Format: This message item is composed of the following elements:

| Index | Name | Tag Name | Occ. |
|-------|--------------------|------------|--------|
| 3.37 | Amount | <Amt> | [1..1] |
| 3.38 | CurrencyOfTransfer | <CcyOfTrf> | [1..1] |

Rules: /

3.37 Amount



Definition: Amount of money to be moved between debtor and creditor, before deduction of charges, expressed in the currency of the debtor's account, and to be moved in a different currency.

Usage: The first agent will convert the equivalent amount into the amount to be moved

XML Tag: <Amt>

Occurrences: [1..1]

Format: fractionDigits: 5
minInclusive: 0
totalDigits: 18

Rules: Maximum 15 digits for other Credit Transfers, two of which for the fractional part and including the decimal separator. E.g.: 999999999999.99

Decimal separator is "."

Currency is explicit and included into the XML-tag.

3.38 CurrencyOfTransfer

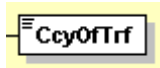

Definition: Specifies the currency of the to be transferred amount, which is different from the currency of the debtor's account.

XML Tag: <CcyOfTrf>

Occurrences: [1..1]

Format: /

Rules: /

3.40 RequestedCollectionDate



Definition: Date and time at which the creditor requests that the amount of money is to be collected from the debtor.

XML Tag: <ReqColltnDt>

Occurrences: [0..1]

Format: ISODate

Rules: /

3.41 RequestedExecutionDate



Definition: Date at which the initiating party requests the clearing agent to process the payment.

XML Tag: <ReqExctnDt>

Occurrences: [0..1]

Format: ISODate

Rules: /

3.42 CreditorSchemeIdentification

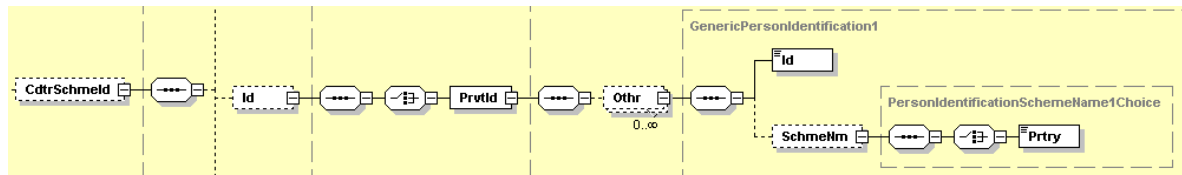

Definition: Credit party that signs the mandate.

XML Tag: <CdtrSchmeId>

Occurrences: [0..1]

Format: This message item is composed of the following element(s):

| Name | XML Tag | Occ |
|-----------------------|-----------|--------|
| Identification | <Id> | [1..1] |
| PrivateIdentification | <PrvtId> | [1..1] |
| Other | <Othr> | [1..1] |
| Identification | <Id> | [1..1] |
| SchemeName | <SchmeNm> | [1..1] |
| Proprietary | <Prtry> | [1..1] |

- Rules:**
- This data element must be present at either 'Payment Information' or 'DirectDebitTransaction' level. It is recommended to use it at 'Payment information' level.
 - SchemeName under 'Other' must specify 'SEPA' as 'Proprietary'.
 - Detail of Identification:
 - Positions 1 and 2 contain the ISO country code
 - Positions 3 and 4 contain the check digits
 - Positions 5 to 7 contain the Creditor Business Code. When the Creditor Business Code is not used, then the value is set to 'ZZZ'
 - Positions 8 up to 35 contain the country-specific identifier

Country specific identifier for Belgium:

- A. Either the Enterprise Number of the Creditor (if it exists)
- B. If no Enterprise Number, the bank will provide to the Creditor a specific number with the following structure:
 - i. Position 8 to 10: protocol code of creditor bank
 - ii. Position 11: "D"
 - iii. Position 12 to 20: increasing number attributed by the bank

3.55 PaymentTypeInformation

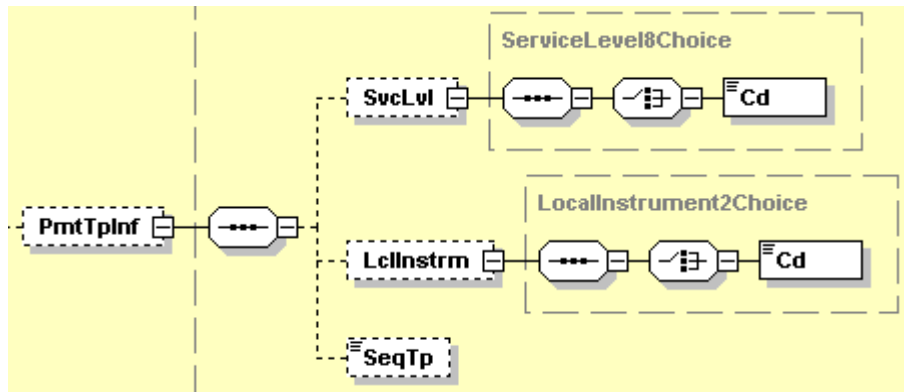

Definition: Set of elements used to further specify the type of transaction.

XML Tag: <PmtTpInf>

Occurrences: [0..1]

Format: This message item is composed of the following element(s):

| Index | Name | XML Tag | Occ. |
|-------|------------------|-------------|--------|
| 3.58 | Service Level | <SvcLvl> | [0..1] |
| 3.59 | Code | <Cd> | [1..1] |
| 3.61 | Local Instrument | <LclInstrm> | [1..1] |
| 3.62 | Code | <Cd> | [1..1] |
| 3.64 | Sequence Type | <SeqTp> | [1..1] |

Rules: /

3.58 ServiceLevel

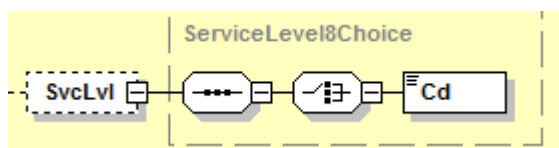

Definition: Agreement under which or rules under which the transaction should be processed.

XML Tag: <SvcLvl>

Occurrences: [0..1]

Format: This message item is composed of one of the following element(s):

| Index | Name | XML Tag |
|-------|------|---------|
| 3.59 | Code | <Cd> |

Rules: /

3.59 Code

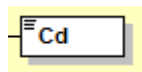

Definition: Specifies a pre-agreed service or level of service between the parties, as published in an [external service level code list](#).

XML Tag: <Cd>

Occurrences: [1..1]

Format: maxLength: 4
minLength: 1

Rules: /

3.61 LocalInstrument

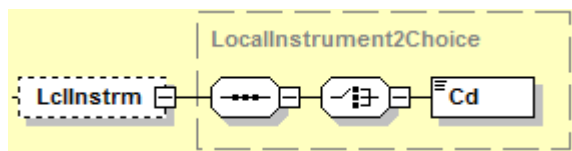

Definition: User community specific instrument.
Usage: This element is used to specify a local instrument, local clearing option and/or further qualify the service or service level.

XML Tag: <LclInstrm>

Occurrences: [0..1]

Format: This message item is composed of one of the following element(s):

| Index | Name | XML Tag |
|-------|------|---------|
| 3.62 | Code | <Cd> |

Rules: /

3.62 Code

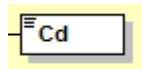

Definition: Specifies the local instrument, as published in an [external local instrument code list](#).

XML Tag: <Cd>

Occurrences: [1..1]

Format: maxLength: 35
minLength: 1

Rules: /

3.64 SequenceType



Definition: Identifies the direct debit sequence, such as first, recurrent, final or one-off.

XML Tag: <SeqTp>

Occurrences: [0..1]

Format: When this message item is present, one of the following values must be used:

| Code | Name | Definition |
|------|-----------|--|
| FNAL | Final | Final collection of a series of direct debit instructions. |
| FRST | First | First collection of a series of direct debit instructions. |
| OOFF | OneOff | Direct debit instruction where the debtor's authorisation is used to initiate one single direct debit transaction. |
| RCUR | Recurring | Direct debit instruction where the debtor's authorisation is used for regular direct debit transactions initiated by the creditor. |

Rules: /

3.69 MandateRelatedInformation

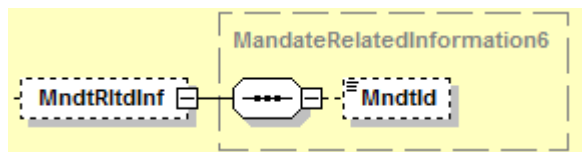

Definition: Set of elements used to provide further details of the mandate signed between the creditor and the debtor.

XML Tag: <MndtRltdInf>

Occurrences: [0..1]

Format: This message item is composed of the following element:

| Index | Name | XML Tag | Occ. |
|-------|-----------------------|----------|--------|
| 3.70 | MandateIdentification | <MndtId> | [0..1] |

Rules: /

3.70 MandateIdentification



Definition: Unique identification, as assigned by the creditor, to unambiguously identify the mandate.

XML Tag: <MndtId>

Occurrences: [0..1]

Format: maxLength: 35, minLength: 1

Rules: /

3.88 RemittanceInformation

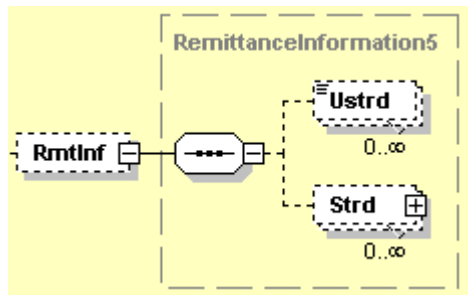

Definition: Information supplied to enable the matching of an entry with the items that the transfer is intended to settle, such as commercial invoices in an accounts' receivable system.

XML Tag: <RmtInf>

Occurrences: [0..1]

Format: This message item is composed of the following elements:

| Index | Name | XML Tag | Occ. |
|-------|--------------|---------|------|
| 3.89 | Unstructured | <Ustrd> | {Or |
| 3.90 | Structured | <Strd> | Or} |

Rules: Either Structured or Unstructured can be present, but not both.

3.89 Unstructured



Definition: Information supplied to enable the matching/reconciliation of an entry with the items that the payment is intended to settle, such as commercial invoices in an accounts' receivable system, in an unstructured form.

XML Tag: <Ustrd>

Occurrences: [0..1]

Format: maxLength: 140 minLength: 1

Rules: /

3.90 Structured



Definition: Information supplied to enable the matching/reconciliation of an entry with the items that the payment is intended to settle, such as commercial invoices in an accounts' receivable system, in a structured form.

XML Tag: <Strd>

Occurrences: [0..1]

Format: This message item is composed of the following element:

| Index | Name | XML Tag | Occ. |
|-------|------------------------------|--------------|--------|
| 3.110 | CreditorReferenceInformation | <CdtrRefInf> | [0..1] |

Rules: /

3.110 CreditorReferenceInformation

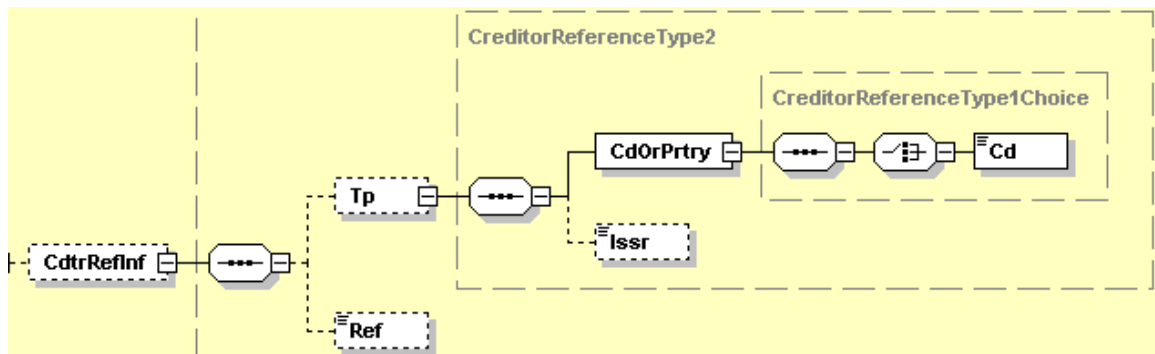

Definition: Reference information provided by the creditor to allow the identification of the underlying documents.

XML Tag: <CdtrRefInf>

Occurrences: [0..1]

Format: This message item consists of the following elements:

| Index | Name | XML Tag | Occ. | Format |
|-------|-------------------|-------------|--------|-------------------|
| 3.111 | Type | <Tp> | [1..1] | |
| 3.112 | CodeOrProprietary | <CdOrPrtry> | [1..1] | |
| 3.113 | Code | <Cd> | [1..1] | Code |
| 3.115 | Issuer | <Issr> | [0..1] | max35Text |
| 3.116 | Reference | <Ref> | [0..1] | Structured Number |

⇒ If the **Belgian Structured Communication** is used, the following value must be used as Code for Type/CodeOrProprietary:

| Code | Name | Definition |
|-------------|-----------------------------------|---|
| SCOR | StructuredCommunication Reference | Document is a structured communication reference provided by the creditor for the purpose of identifying the transaction referred to. |

The following value must be used as Issuer for Type:

| Code | Name | Definition |
|------------|--|--|
| BBA | The Belgian Bankers' and Stockbroking Firms' Association | The Belgian Bankers' and Stockbroking Firms' Association |

⇒ If the **RF Creditor Reference** is used, the following value must be used as **Code** for Type:

| Code | Name | Definition |
|-------------|-----------------------------------|---|
| SCOR | StructuredCommunication Reference | Document is a structured communication reference provided by the creditor for the purpose of identifying the transaction referred to. |

The following value must be used as **Issuer** for Type:

| Code | Name | Definition |
|------------|-----------------------|--|
| ISO | RF Creditor Reference | ISO Structured Creditor reference to remittance information. |

⇒ In all other cases **Code** must be SCOR and **Issuer** must not be used.

3.111 Type

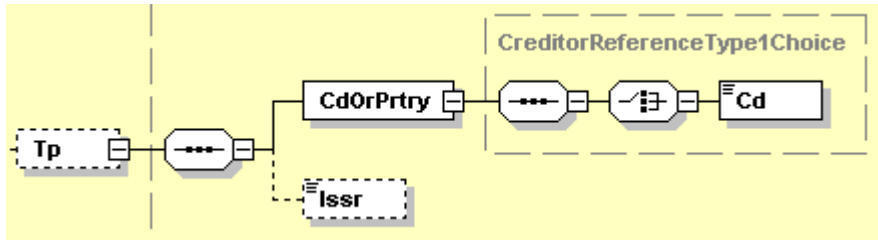

Definition: Specifies the type of creditor reference.

XML Tag: <Tp>

Occurrences: [0..1]

Format: This element is composed of the following elements:

| Index | Name | XMLTag | Occ. |
|-------|-------------------|-------------|--------|
| 3.112 | CodeOrProprietary | <CdOrPrtry> | [1..1] |
| 3.115 | Issuer | <Issr> | [0..1] |

Rules: /

3.112 CodeOrProprietary

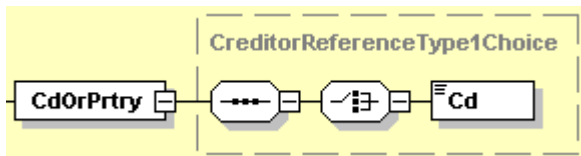

Definition: Coded or proprietary format creditor reference type.

XML Tag: <CdOrPrtry>

Occurrences: [1..1]

Format: This message item is composed of the following element:

| Index | Name | XML Tag | Occ. |
|-------|------|---------|--------|
| 3.113 | Code | <Cd> | [1..1] |

Rules: /

3.113 Code

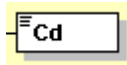

This message item is part of choice 3.112 CodeOrProprietary.

Definition: Type of creditor reference, in a coded form.

XML Tag: <Cd>

Occurrences: [1..1]

Format: The following value must be used:

| Name | Name | Definition |
|------|----------------------------------|---|
| SCOR | StructuredCommunicationReference | Document is a structured communication reference provided by the creditor to identify the referred transaction. |

Rules: /

3.115 Issuer



Definition: Entity that assigns the credit reference type.

XML Tag: <Issr>

Occurrences: [0..1]

Format: Max35Text

Rules: /

3.116 Reference

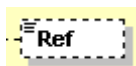

Definition: Unique reference, as assigned by the creditor, to unambiguously refer to the payment transaction.

XML Tag: <Ref>

Occurrences: [0..1]

Format: Max35Text

Rules: /

3.121 Debtor

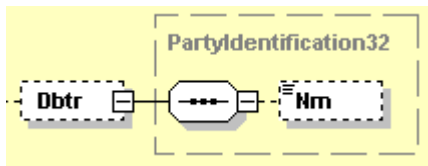

Definition: Party that owes an amount of money to the (ultimate) creditor.

XML Tag: <Dbtr>

Occurrences: [0..1]

Format: This message item is composed of the following element(s):

| Name | XML Tag | Occ. | Format |
|------|---------|--------|-----------|
| Name | <Nm> | [1..1] | Max70Text |

Rules: /

3.122 DebtorAccount

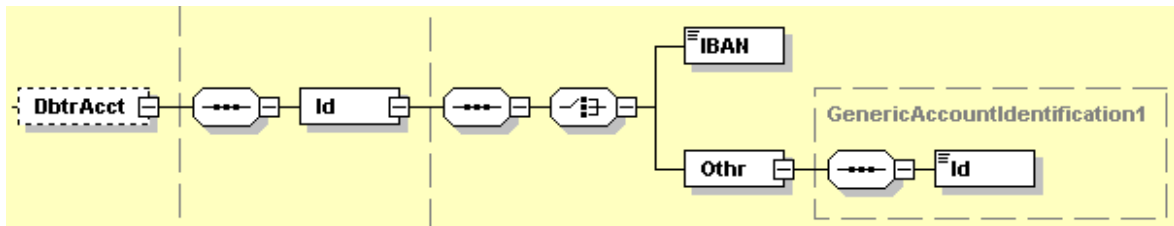

Definition: Unambiguous identification of the account of the debtor to which a debit entry will be made as a result of the transaction.

XML Tag: <DbtrAcct>

Occurrences: [0..1]

Format: This message item is composed of the following element(s):

| Name | XML Tag | Occ. | Format |
|----------------|---------|------------|-------------------|
| Identification | <Id> | [1..1] | |
| IBAN | <IBAN> | [1..1]{Or | IBAN-format |
| Other | <Othr> | [1..1] Or} | |
| Identification | <Id> | [1..1] | Text |
| Currency | <Ccy> | [0..1] | ISO Currency Code |

Rules: /

3.123 DebtorAgent

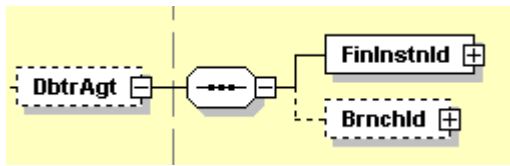

Definition: Financial institution servicing an account for the debtor.

XML Tag: <DbtrAgt>

Occurrences: [0..1]

Format: This message item is composed of the following element(s):

| Name | XML Tag | Occ. | Format |
|------------------------------------|--------------|--------|------------|
| FinancialInstitutionIdentification | <FinInstnId> | [1..1] | |
| BIC | <BIC> | [1..1] | BIC-format |

Rules: /

3.125 CreditorAgent

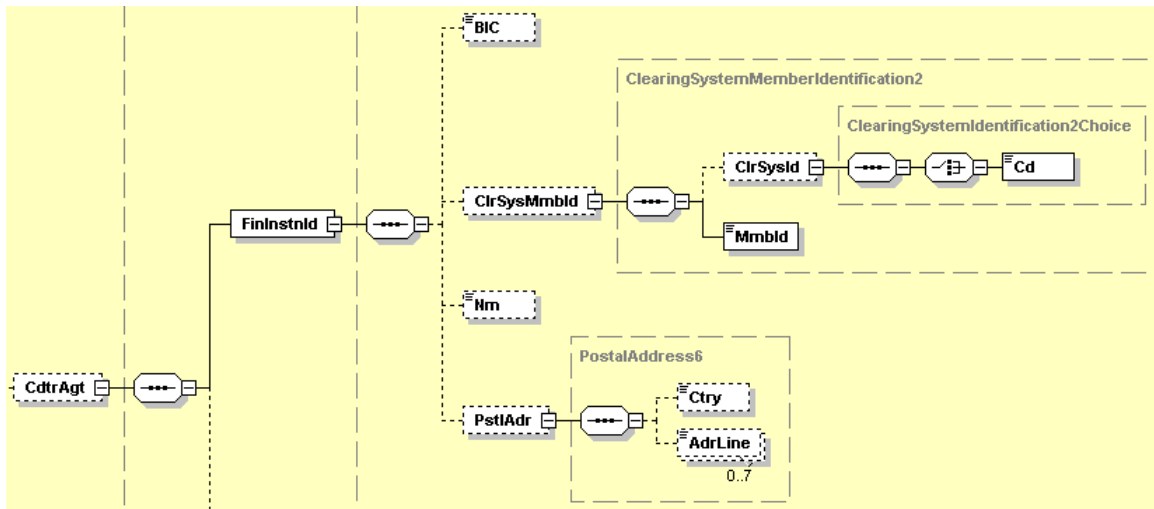

Definition: Financial institution servicing an account for the creditor.

XML Tag: <CdrAgt>

Occurrences: [0..1]

Format: This message item is composed of the following element(s):

| Name | XML Tag | Occ. | Format |
|------------------------------------|---------------|--------|--------------------------|
| FinancialInstitutionIdentification | <FinInstnId> | [1..1] | |
| BIC | <BIC> | [0..1] | Identifier |
| ClearingSystemMemberIdentification | <ClrSysMmbld> | [0..1] | |
| ClearingSystemIdentification | <ClrSysId> | [0..1] | List of Clearing Systems |
| Code | <Cd> | [1..1] | Code |
| MemberIdentification | <Mmbld> | [1..1] | Text |
| Name | <Nm> | [0..1] | Max70Text |
| PostalAddress | <PstlAdr> | [0..1] | |
| Country | <Ctry> | [0..1] | Code |
| AddressLine | <AdrLine> | [0..2] | Text |

Rules: /

3.127 Creditor

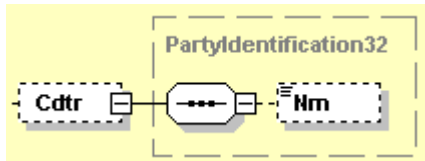

Definition: Party to which an amount of money is due.

XML Tag: <Cdtr>

Occurrences: [0..1]

Format: This message item is composed of the following element(s):

| Name | XML Tag | Occ. | Format |
|------|---------|--------|-----------|
| Name | <Nm> | [1..1] | Max70Text |

Rules: /

3.128 CreditorAccount

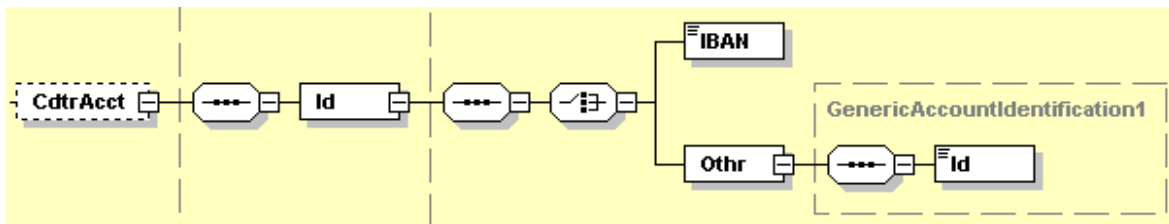

Definition: Unambiguous identification of the account of the creditor to which a credit entry will be posted as a result of the payment transaction.

XML Tag: <CdtrAcct>

Occurrences: [0..1]

Format: This message item is composed of the following element(s):

| Name | XML Tag | Occ. | Format |
|----------------|---------|------------|-------------|
| Identification | <Id> | [1..1] | |
| IBAN | <IBAN> | [1..1]{Or | IBAN-format |
| Other | <Othr> | [1..1] Or} | |
| Identification | <Id> | [1..1] | Text |

Rules: /

4 Statuscodes

| Code | Name | Definition |
|------|------------------------------|--|
| ACCP | AcceptedCustomerProfile | Preceding check of technical validation was successful. Customer profile check was also successful. |
| ACSC | AcceptedSettlementCompleted | Settlement on the debtor's account has been completed. Usage : this can be used by the first agent to report to the debtor that the transaction has been completed. Warning : this status is provided for transaction status reasons, not for financial information. It can only be used after bilateral agreement |
| ACSP | AcceptedSettlementInProgress | All preceding checks such as technical validation and customer profile were successful and therefore the payment initiation has been accepted for execution. |
| ACTC | AcceptedTechnicalValidation | Authentication and syntactical and semantical validation are successful. |
| ACWC | AcceptedWithChange | Instruction is accepted but a change will be made, such as date or remittance not sent. |
| PART | PartiallyAccepted | A number of transactions have been accepted, whereas another number of transactions have not yet achieved 'accepted' status. |
| PDNG | Pending | Payment initiation or individual transaction included in the payment initiation is pending. Further checks and status update will be performed. |
| RCVD | Received | Payment initiation has been received by the receiving agent. |
| RJCT | Rejected | Payment initiation or individual transaction included in the payment initiation has been rejected. |

5 List of Status Reason codes.

ExternalStatusReason1Code

| | Code | Name | Definition |
|----|------|--------------------------------|---|
| 1 | AC01 | IncorrectAccountNumber | Account number is invalid or missing. Formerly: Format of the account number specified is not correct. |
| 2 | AC02 | InvalidDebtorAccountNumber | Debtor account number invalid or missing |
| 3 | AC03 | InvalidCreditorAccountNumber | Creditor account number invalid or missing |
| 4 | AC04 | ClosedAccountNumber | Account number specified has been closed on the bank of account's books. |
| 5 | AC05 | ClosedDebtorAccountNumber | Debtor account number closed |
| 6 | AC06 | BlockedAccount | Account specified is blocked, prohibiting posting of transactions against it. |
| 7 | AC07 | ClosedCreditorAccountNumber | Creditor account number closed |
| 8 | AC08 | InvalidBranchCode | Branch code is invalid or missing |
| 9 | AC09 | InvalidAccountCurrency | Account currency is invalid or missing |
| 10 | AC10 | InvalidDebtorAccountCurrency | Debtor account currency is invalid or missing |
| 11 | AC11 | InvalidCreditorAccountCurrency | Creditor account currency is invalid or missing |
| 12 | AC12 | InvalidAccountType | Account type missing or invalid. Generic usage if cannot specify between group and payment information levels |
| 13 | AC13 | InvalidDebtorAccountType | Debtor account type missing or invalid |
| 14 | AC14 | InvalidCreditorAccountType | Creditor account type missing or invalid |
| 15 | AG01 | TransactionForbidden | Transaction forbidden on this type of account (formerly NoAgreement) |
| 16 | AG02 | InvalidBankOperationCode | Bank Operation code specified in the message is not valid for receiver |
| 17 | AG03 | TransactionNotSupported | Transaction type not supported/authorized on this account |
| 18 | AG04 | InvalidAgentCountry | Agent country code is missing or invalid. Generic usage if cannot specify between group and payment information levels. |
| 19 | AG05 | InvalidDebtorAgentCountry | Debtor agent country code is missing or invalid |
| 20 | AG06 | InvalidCreditorAgentCountry | Creditor agent country code is missing or invalid |
| 21 | AG07 | UnsuccessfulDirectDebit | Debtor account cannot be debited for a generic reason. Code value may be used in general purposes and as a replacement for AM04 if debtor bank does not reveal its customer's insufficient funds for privacy reasons |
| 22 | AG08 | InvalidAccessRights | Transaction failed due to invalid or missing user or access right |
| 23 | AGNT | IncorrectAgent | Agent in the payment workflow is incorrect |

| | | | |
|----|------|---|---|
| 24 | AM01 | ZeroAmount | Specified message amount is equal to zero |
| 25 | AM02 | NotAllowedAmount | Specific transaction/message amount is greater than allowed maximum |
| 26 | AM03 | NotAllowedCurrency | Specified message amount is an non processable currency outside of existing agreement |
| 27 | AM04 | InsufficientFunds | Amount of funds available to cover specified message amount is insufficient. |
| 28 | AM05 | Duplication | Duplication |
| 29 | AM06 | TooLowAmount | Specified transaction amount is less than agreed minimum. |
| 30 | AM07 | BlockedAmount | Amount of funds available to cover specified message amount is insufficient. |
| 31 | AM09 | WrongAmount | Amount received is not the amount agreed or expected |
| 32 | AM10 | InvalidControlSum | Sum of instructed amounts does not equal the control sum. |
| 33 | AM11 | InvalidTransactionCurrency | Transaction currency is invalid or missing |
| 34 | AM12 | InvalidAmount | Amount is invalid or missing |
| 35 | AM13 | AmountExceedsClearing SystemLimit | Transaction amount exceeds limits set by clearing system |
| 36 | AM14 | AmountExceedsAgreedLimit | Transaction amount exceeds limits agreed between bank and client |
| 37 | AM15 | AmountBelowClearing SystemMinimum | Transaction amount below minimum set by clearing system |
| 38 | AM16 | InvalidGroupControlSum | Control Sum at the Group level is invalid |
| 39 | AM17 | InvalidPaymentInfoControlSum | Control Sum at the Payment Information level is invalid |
| 40 | AM18 | InvalidNumberOfTransactions | Number of transactions is invalid or missing. Generic usage if cannot specify between group and payment information levels. |
| 41 | AM19 | InvalidGroupNumberOf Transactions | Number of transactions at the Group level is invalid or missing |
| 42 | AM20 | InvalidPaymentInfoNumber OfTransactions | Number of transactions at the Payment Information level is invalid |
| 43 | BE01 | InconsistenWithEndCustomer | Identification of end customer is not consistent with associated account number. (formerly CreditorConsistency). |
| 44 | BE04 | MissingCreditorAddress | Specification of creditor's address, which is required for payment, is missing/not correct (formerly IncorrectCreditorAddress). |
| 45 | BE05 | UnrecognisedInitiatingParty | Party who initiated the message is not recognised by the end customer |
| 46 | BE06 | UnknownEndCustomer | End customer specified is not known at associated Sort/National Bank Code or does no longer exist in the books |
| 47 | BE07 | MissingDebtorAddress | Specification of debtor's address, which is required for payment, is missing/not correct. |
| 48 | BE08 | MissingDebtorName | Debtor name is missing |

| | | | |
|----|------|--|--|
| 49 | BE09 | InvalidCountry | Country code is missing or Invalid. Generic usage if cannot specifically identify debtor or creditor |
| 50 | BE10 | InvalidDebtorCountry | Debtor country code is missing or invalid |
| 51 | BE11 | InvalidCreditorCountry | Creditor country code is missing or invalid |
| 52 | BE12 | InvalidCountryOfResidence | Country code of residence is missing or Invalid. Generic usage if cannot specifically identify debtor or creditor |
| 53 | BE13 | InvalidDebtorCountryOfResidence | Country code of debtor's residence is missing or Invalid |
| 54 | BE14 | InvalidCreditorCountryOfResidence | Country code of creditor's residence is missing or Invalid |
| 55 | BE15 | InvalidIdentificationCode | Identification code missing or invalid. Generic usage if cannot specifically identify debtor or creditor. |
| 56 | BE16 | InvalidDebtorIdentificationCode | Debtor or Ultimate Debtor identification code missing or invalid |
| 57 | BE17 | InvalidCreditorIdentificationCode | Creditor or Ultimate Creditor identification code missing or invalid |
| 58 | BE18 | InvalidContactDetails | Contact details missing or invalid |
| 59 | BE19 | InvalidChargeBearerCode | Charge bearer code for transaction type is invalid |
| 60 | BE20 | InvalidNameLength | Name length exceeds local rules for payment type. |
| 61 | BE21 | MissingName | Name missing or invalid. Generic usage if cannot specifically identify debtor or creditor. |
| 62 | BE22 | MissingCreditorName | Creditor name is missing |
| 63 | CURR | IncorrectCurrency | Currency of the payment is incorrect |
| 64 | CUST | RequestedByCustomer | Cancellation requested by the Debtor |
| 65 | DS0A | DataSignRequested | Data signature is required. |
| 66 | DS0B | UnknownDataSignFormat | Data signature for the format is not available or invalid. |
| 67 | DS0C | SignerCertificateRevoked | The signer certificate is revoked. |
| 68 | DS0D | SignerCertificateNotValid | The signer certificate is not valid (revoked or not active). |
| 69 | DS0E | IncorrectSignerCertificate | The signer certificate is not present. |
| 70 | DS0F | SignerCertificationAuthoritySignerNotValid | The authority of the signer certification sending the certificate is unknown. |
| 71 | DS0G | NotAllowedPayment | Signer is not allowed to sign this operation type. |
| 72 | DS0H | NotAllowedAccount | Signer is not allowed to sign for this account. |
| 73 | DS0K | NotAllowedNumberOfTransaction | The number of transaction is over the number allowed for this signer. |
| 74 | DS10 | Signer1CertificateRevoked | The certificate is revoked for the first signer. |
| 75 | DS11 | Signer1CertificateNotValid | The certificate is not valid (revoked or not active) for the first signer. |

| | | | |
|-----|------|---|---|
| 76 | DS12 | IncorrectSigner1Certificate | The certificate is not present for the first signer. |
| 77 | DS13 | SignerCertificationAuthority Signer1NotValid | The authority of signer certification sending the certificate is unknown for the first signer. |
| 78 | DS20 | Signer2CertificateRevoked | The certificate is revoked for the second signer. |
| 79 | DS21 | Signer2CertificateNotValid | The certificate is not valid (revoked or not active) for the second signer. |
| 80 | DS22 | IncorrectSigner2Certificate | The certificate is not present for the second signer. |
| 81 | DS23 | SignerCertificationAuthority Signer2NotValid | The authority of signer certification sending the certificate is unknown for the second signer. |
| 82 | DT01 | InvalidDate | Invalid date (eg, wrong or missing settlement date) |
| 83 | DT02 | InvalidCreationDate | Invalid creation date and time in Group Header (eg, historic date) |
| 84 | DT03 | InvalidNonProcessingDate | Invalid non bank processing date (eg, weekend or local public holiday) |
| 85 | DT04 | FutureDateNotSupported | Future date not supported |
| 86 | DT05 | InvalidCutOffDate | Associated message, payment information block or transaction was received after agreed processing cut-off date, i.e., date in the past. |
| 87 | DT06 | ExecutionDateChanged | Execution Date has been modified in order for transaction to be processed |
| 88 | DU01 | DuplicateMessageID | Message Identification is not unique. |
| 89 | DU02 | DuplicatePaymentInformationID | Payment Information Block is not unique. |
| 90 | DU03 | DuplicateTransaction | Transaction is not unique. |
| 91 | DU04 | DuplicateEndToEndID | End To End ID is not unique. |
| 92 | DU05 | DuplicateInstructionID | Instruction ID is not unique. |
| 93 | DUPL | DuplicatePayment | Payment is a duplicate of another payment |
| 94 | ED01 | CorrespondentBankNotPossible | Correspondent bank not possible. |
| 95 | ED03 | BalanceInfoRequest | Balance of payments complementary info is requested |
| 96 | ED05 | SettlementFailed | Settlement of the transaction has failed. |
| 97 | FF01 | Invalid File Format | File Format incomplete or invalid |
| 98 | FF02 | SyntaxError | Syntax error reason is provided as narrative information in the additional reason information. |
| 99 | FF03 | InvalidPaymentTypeInfoInformation | Payment Type Information is missing or invalid. Generica usage if cannot specify Service Level or Local Instrument code |
| 100 | FF04 | InvalidServiceLevelCode | Service Level code is missing or invalid |
| 101 | FF05 | InvalidLocalInstrumentCode | Local Instrument code is missing or invalid |
| 102 | FF06 | InvalidCategoryPurposeCode | Category Purpose code is missing or invalid |
| 103 | FF07 | InvalidPurpose | Purpose is missing or invalid |

| | | | |
|-----|------|---|---|
| 104 | FF08 | InvalidEndToEndId | End to End Id missing or invalid |
| 105 | FF09 | InvalidChequeNumber | Cheque number missing or invalid |
| 106 | FF10 | BankSystemProcessingError | File or transaction cannot be processed due to technical issues at the bank side |
| 107 | MD01 | NoMandate | No Mandate |
| 108 | MD02 | MissingMandatoryInformationInMandate | Mandate related information data required by the scheme is missing. |
| 109 | MD05 | CollectionNotDue | Creditor or creditor's agent should not have collected the direct debit |
| 110 | MD06 | RefundRequestByEndCustomer | Return of funds requested by end customer |
| 111 | MD07 | EndCustomerDeceased | End customer is deceased. |
| 112 | MS02 | NotSpecifiedReasonCustomerGenerated | Reason has not been specified by end customer |
| 113 | MS03 | NotSpecifiedReasonAgentGenerated | Reason has not been specified by agent. |
| 114 | NARR | Narrative | Reason is provided as narrative information in the additional reason information. |
| 115 | RC01 | BankIdentifierIncorrect | Bank Identifier code specified in the message has an incorrect format (formerly IncorrectFormatForRoutingCode). |
| 116 | RC02 | InvalidBankIdentifier | Bank identifier is invalid or missing. Generic usage if cannot specify between debit or credit account |
| 117 | RC03 | InvalidDebtorBankIdentifier | Debtor bank identifier is invalid or missing |
| 118 | RC04 | InvalidCreditorBankIdentifier | Creditor bank identifier is invalid or missing |
| 119 | RC05 | InvalidBICIdentifier | BIC identifier is invalid or missing. Generic usage if cannot specify between debit or credit account. |
| 120 | RC06 | InvalidDebtorBICIdentifier | Debtor BIC identifier is invalid or missing |
| 121 | RC07 | InvalidCreditorBICIdentifier | Creditor BIC identifier is invalid or missing |
| 122 | RC08 | InvalidClearingSystemMemberIdentifier | ClearingSystemMemberIdentifier is invalid or missing. Generic usage if cannot specify between debit or credit account |
| 123 | RC09 | InvalidDebtorClearingSystemMemberIdentifier | Debtor ClearingSystemMember identifier is invalid or missing |
| 124 | RC10 | InvalidCreditorClearingSystemMemberIdentifier | Creditor ClearingSystemMember identifier is invalid or missing |
| 125 | RC11 | InvalidIntermediaryAgent | Intermediary Agent is invalid or missing |
| 126 | RC12 | MissingCreditorSchemeId | Creditor Scheme Id is invalid or missing |
| 127 | RF01 | NotUniqueTransactionReference | Transaction reference is not unique within the message. |
| 128 | RR01 | Missing Debtor Account or Identification | Specification of the debtor's account or unique identification needed for reasons of regulatory requirements is insufficient or missing |
| 129 | RR02 | Missing Debtor Name or Address | Specification of the debtor's name and/or address needed for regulatory requirements is insufficient or missing. |

| | | | |
|-----|------|--|--|
| 130 | RR03 | Missing Creditor Name or Address | Specification of the creditor's name and/or address needed for regulatory requirements is insufficient or missing. |
| 131 | RR04 | Regulatory Reason | Regulatory Reason |
| 132 | RR05 | RegulatoryInformationInvalid | Regulatory or Central Bank Reporting information missing, incomplete or invalid. |
| 133 | RR06 | TaxInformationInvalid | Tax information missing, incomplete or invalid. |
| 134 | RR07 | RemittanceInformationInvalid | Remittance information structure does not comply with rules for payment type. |
| 135 | RR08 | RemittanceInformation Truncated | Remittance information truncated to comply with rules for payment type. |
| 136 | RR09 | InvalidStructuredCreditor Reference | Structured creditor reference invalid or missing. |
| 137 | RR10 | InvalidCharacterSet | Character set supplied not valid for the country and payment type. |
| 138 | RR11 | InvalidDebtorAgentServiceID | Invalid or missing identification of a bank proprietary service. |
| 139 | RR12 | InvalidPartyID | Invalid or missing identification required within a particular country or payment type. |
| 140 | SL01 | Specific Service offered by Debtor Agent | Due to specific service offered by the Debtor Agent |
| 141 | SL02 | Specific Service offered by Creditor Agent | Due to specific service offered by the Creditor Agent |
| 142 | TM01 | InvalidCutOffTime Formerly: CutOffTime | Associated message, payment information block, or transaction was received after agreed processing cut-off time. |

www.febelfin.be



Belgian Financial sector Federation

Rue d'Arlon/Aarlenstraat 82 | 1040 Brussels
T 02 507 68 11 | info@febelfin.be | www.febelfin.be