

# XML message for statement

## Implementation Guidelines

Final Version 2.1 (changes in chapter 8.2)



## Table of Contents

1. Introduction	9
A.1. Scope	9
A.2. General principles	9
A.2.1. Contents of the message :	9
A.2.2. Periodicity of the message	9
A.2.3. Transactions encoding	9
A.2.4. Globalisation of transactions	10
A.2.5. Reporting of structured communications	10
A.3. Use of these guidelines	10
A.4. Message structure	11
2. Message Structure	15
3. Message Item Description	25
1.0 GroupHeader	25
1.1 MessageIdentification <MsgId>	26
1.2 CreationDateTime <CreDtTm>	26
1.3 MessageRecipient <MsgRcpt>	26
9.1.0 Name <Nm>	27
1.4 MessagePagination <MsgPgntn>	27
8.2.0 PageNumber <PgNb>	28
8.2.1 LastPageIndicator <LastPgInd>	28
1.5 AdditionalInformation <AddtlInf>	28
2.0 Statement	29
2.1 Identification	29
2.2 ElectronicSequenceNumber <ElctrncSeqNb>	30
2.3 LegalSequenceNumber <LglSeqNb>	30
2.4 CreationDateTime <CreDtTm>	30
2.5 FromToDate <FrToDt>	31
5.1.0 FromDateTime <FrDtTm>	31
5.1.1 ToDateTime <ToDtTm>	31
2.6 CopyDuplicateIndicator <CpyDplctInd>	32
2.10 Account <Acct>	33
1.2.0 Identification <Id>	34
1.2.1 IBAN <IBAN>	34
1.2.2 Other <Othr>	35
1.2.3 Identification <Id>	35
1.2.8 Type <Tp>	35
1.2.10 Proprietary <Prtry>	36
1.2.11 Currency <Ccy>	36
1.2.12 Name <Nm>	36
1.2.13 Owner <Ownr>	37
1.2.14 Name <Nm>	37
1.2.26 Identification <Id>	37
1.2.27 OrganisationIdentification <OrgId>	38
1.2.29 Other <Othr>	38
1.2.30 Identification <Id>	38
1.2.56 Servicer <Svcr>	39
1.2.57 FinancialInstitutionIdentification <FinInstnId>	39
1.2.58 BIC <BIC>	40
2.11 RelatedAccount <RltdAcct>	40
1.1.0 Identification <Id>	41
1.1.1 IBAN <IBAN>	41
1.1.2 Other <Othr>	42
1.1.3 Identification <Id>	42
2.23 Balance <Bal>	43

2.24	Type <Tp>	44
2.25	CodeOrProprietary <CdOrPrtry>	44
2.26	Code <Cd>	45
2.27	Proprietary <Prtry>	45
2.28	SubType <SubTp>	46
2.29	Code <Cd>	46
2.34	Amount <Amt>	47
2.35	CreditDebitIndicator <CdtDbtInd>	48
2.36	Date <Dt>	48
4.1.0	Date <Dt>	48
2.43	TransactionsSummary <TxsSummry>	49
2.44	TotalEntries <TtlNtries>	49
2.45	NumberOfEntries <NbOfNtries>	50
2.46	Sum <Sum>	50
2.47	TotalNetEntryAmount <TtlNetNtryAmt>	50
2.48	CreditDebitIndicator <CdtDbtInd>	50
2.49	TotalCreditEntries <TtlCdtNtries>	51
2.50	NumberOfEntries <NbOfNtries>	51
2.51	Sum <Sum>	51
2.52	TotalDebitEntries <TtlDbtNtries>	52
2.53	NumberOfEntries <NbOfNtries>	52
2.54	Sum <Sum>	52
2.76	Entry <Ntry>	53
2.77	EntryReference <NtryRef>	54
2.78	Amount <Amt>	55
2.79	CreditDebitIndicator <CdtDbtInd>	56
2.80	ReversalIndicator <Rvsllnd>	56
2.81	Status <Sts>	57
2.82	BookingDate <BookgDt>	57
4.1.0	Date <Dt>	58
2.83	ValueDate <ValDt>	58
4.1.0	Date <Dt>	58
2.84	AccountServicerReference <AcctSvcrRef>	59
2.91	BankTransactionCode <BkTxCd>	60
2.92	Domain <Domn>	61
2.93	Code <Cd>	61
2.94	Family <Fmly>	61
2.95	Code <Cd>	62
2.96	SubFamilyCode <SubFmlyCd>	62
2.97	Proprietary <Prtry>	62
2.98	Code <Cd>	63
2.99	Issuer <Issr>	63
2.101	AdditionalInformationIndicator <AddtlInfInd>	63
2.102	MessageNameIdentification <MsgNmId>	64
2.103	MessageIdentification <MsgId>	64
2.104	mountDetails <AmtDtls>	65
2.1.0	InstructedAmount <InstdAmt>	66
2.1.1	Amount <Amt>	66
2.1.9	TransactionAmount <TxAmt>	67
2.1.10	Amount <Amt>	67
2.1.18	CounterValueAmount <CntrValAmt>	68
2.1.19	Amount <Amt>	68
2.1.20	CurrencyExchange <CcyXchg>	69
2.1.21	SourceCurrency <SrcCcy>	69
2.1.22	TargetCurrency <TrgtCcy>	69
2.1.23	UnitCurrency <UnitCcy>	70
2.1.24	ExchangeRate <XchgRate>	70
2.1.36	ProprietaryAmount <PrtryAmt>	70

2.1.37	Type <Tp>	71
2.1.38	Amount <Amt>	71
2.105	Charges <Chrgs>	72
2.107	Amount <Amt>	73
2.108	CreditDebitIndicator <CdtDbtInd>	74
2.109	Type <Tp>	74
2.111	Proprietary <Prtry>	74
7.1.0	Identification <Id>	75
7.1.1	Issuer <Issr>	75
2.112	Rate <Rate>	75
2.115	Tax <Tax>	76
2.116	Identification <Id>	76
2.117	Rate <Rate>	76
2.118	Amount <Amt>	77
2.135	EntryDetails <NtryDtls>	78
2.136	Batch <Btch>	78
2.137	MessageIdentification <Msgld>	79
2.138	PaymentInformationIdentification <PmtInfld>	79
2.139	NumberOfTransactions <NbOfTxs>	79
2.140	TotalAmount <TtlAmt>	80
2.141	CreditDebitIndicator <CdtDbtInd>	80
2.142	TransactionDetails <TxDtls>	81
2.143	References <Refs>	82
2.144	MessageIdentification <Msgld>	83
2.145	AccountServicerReference <AcctSvcrRef>	83
2.146	PaymentInformationIdentification <PmtInfld>	83
2.147	InstructionIdentification <Instrld>	84
2.148	EndToEndIdentification <EndToEndld>	84
2.149	TransactionIdentification <Txld>	85
2.150	MandateIdentification <Mndtld>	85
2.151	ChequeNumber <ChqNb>	85
2.153	Proprietary <Prtry>	86
2.154	Type <Tp>	86
2.155	Reference <Ref>	86
2.156	AmountDetails <AmtDtls>	87
2.1.0	InstructedAmount <InstdAmt>	88
2.1.1	Amount <Amt>	88
2.1.9	TransactionAmount <TxAmt>	89
2.1.10	Amount <Amt>	89
2.1.18	CounterValueAmount <CntrValAmt>	90
2.1.19	Amount <Amt>	90
2.1.20	CurrencyExchange <CcyXchg>	91
2.1.21	SourceCurrency <SrcCcy>	91
2.1.22	TargetCurrency <TrgtCcy>	91
2.1.23	UnitCurrency <UnitCcy>	92
2.1.24	ExchangeRate <XchgRate>	92
2.1.36	ProprietaryAmount <PrtryAmt>	92
2.1.37	Type <Tp>	93
2.1.38	Amount <Amt>	93
2.163	BankTransactionCode <BkTxCd>	94
2.164	Domain <Domn>	95
2.165	Code <Cd>	95
2.166	Family <Fmly>	95
2.167	Code <Cd>	96
2.168	SubFamilyCode <SubFmlyCd>	96
2.169	Proprietary <Prtry>	96
2.170	Code <Cd>	97
2.171	Issuer <Issr>	97

2.172	Charges <Chrgs>	98
2.174	Amount <Amt>	99
2.175	CreditDebitIndicator <CdtDbtInd>	99
2.176	Type <Tp>	100
2.178	Proprietary <Prtry>	100
7.1.0	Identification <Id>	100
7.1.1	Issuer <Issr>	101
2.179	Rate <Rate>	101
2.182	Tax <Tax>	101
2.183	Identification <Id>	102
2.184	Rate <Rate>	102
2.185	Amount <Amt>	103
2.186	Interest <Intrst>	104
2.187	Amount <Amt>	105
2.188	CreditDebitIndicator <CdtDbtInd>	105
2.189	Type <Tp>	106
2.191	Proprietary <Prtry>	106
2.192	Rate <Rate>	106
2.193	Type <Tp>	107
2.194	Percentage <Pctg>	107
2.195	Other <Othr>	107
2.197	FromDate <FrToDt>	108
5.1.0	FromDateTime <FrDtTm>	108
5.1.1	ToDateTime <ToDtTm>	108
2.199	RelatedParties <RltdPties>	109
2.200	InitiatingParty <InitgPty>	110
9.1.0	Name <Nm>	110
9.1.1	PostalAddress <PstlAdr>	111
9.1.5	StreetName <StrtNm>	111
9.1.6	BuildingNumber <BldgNb>	112
9.1.7	PostCode <PstCd>	112
9.1.8	TownName <TwnNm>	112
9.1.10	country <Ctry>	112
9.1.11	AddressLine <AdrLine>	113
2.201	Debtor <Dbtr>	113
9.1.0	Name <Nm>	113
9.1.1	PostalAddress <PstlAdr>	114
9.1.5	StreetName <StrtNm>	114
9.1.6	BuildingNumber <BldgNb>	115
9.1.7	PostCode <PstCd>	115
9.1.8	TownName <TwnNm>	115
9.1.10	Country <Ctry>	116
9.1.11	AddressLine <AdrLine>	116
9.1.12	Identification <Id>	116
9.1.13	OrganisationIdentification <OrgId>	117
9.1.14	BICOrBEI <BICOrBEI>	117
2.202	DebtorAccount <DbtrAcct>	118
1.1.0	Identification <Id>	118
1.1.1	IBAN <IBAN>	119
1.1.2	Other <Othr>	119
1.1.3	Identification <Id>	120
1.1.7	Issuer <Issr>	120
2.203	UltimateDebtor <UltmtDbtr>	121
9.1.0	Name <Nm>	121
9.1.1	PostalAddress <PstlAdr>	122
9.1.5	StreetName <StrtNm>	122
9.1.6	BuildingNumber <BldgNb>	123
9.1.7	PostCode <PstCd>	123

9.1.8	TownName <TwnNm>	123
9.1.10	Country <Ctry>	123
9.1.11	AddressLine <AdrLine>	124
9.1.12	Identification <Id>	124
9.1.13	OrganisationIdentification <OrgId>	124
9.1.14	BICOrBEI <BICOrBEI>	125
9.1.15	Other <Othr>	125
9.1.16	Identification <Id>	125
2.204	Creditor <Cdtr>	126
9.1.0	Name <Nm>	126
9.1.1	PostalAddress <PstlAdr>	127
9.1.5	StreetName <StrtNm>	127
9.1.6	BuildingNumber <BldgNb>	128
9.1.7	PostCode <PstCd>	128
9.1.8	TownName <TwnNm>	128
9.1.10	Country <Ctry>	129
9.1.11	AddressLine <AdrLine>	129
9.1.12	Identification <Id>	130
9.1.13	OrganisationIdentification <OrgId>	130
9.1.14	BICOrBEI <BICOrBEI>	131
9.1.15	Other <Othr>	131
9.1.16	Identification <Id>	131
2.205	CreditorAccount <CdtrAcct>	132
1.1.0	Identification <Id>	132
1.1.1	IBAN <IBAN>	133
1.1.2	Other <Othr>	133
1.1.3	Identification <Id>	133
1.1.7	Issuer <Issr>	134
2.206	UltimateCreditor <UltmtCdtr>	134
9.1.0	Name <Nm>	134
9.1.1	PostalAddress <PstlAdr>	135
9.1.5	StreetName <StrtNm>	135
9.1.6	BuildingNumber <BldgNb>	136
9.1.7	PostCode <PstCd>	136
9.1.8	TownName <TwnNm>	136
9.1.10	Country <Ctry>	136
9.1.11	AddressLine <AdrLine>	137
9.1.12	Identification <Id>	137
9.1.13	OrganisationIdentification <OrgId>	137
9.1.14	BICOrBEI <BICOrBEI>	138
9.1.15	Other <Othr>	138
9.1.16	Identification <Id>	138
2.211	RelatedAgents <RltdAgts>	139
2.212	DebtorAgent <DbtrAgt>	139
6.1.0	FinancialInstitutionIdentification <FinInstnId>	140
6.1.1	BIC <BIC>	140
2.213	CreditorAgent <CdtrAgt>	141
6.1.0	FinancialInstitutionIdentification <FinInstnId>	141
6.1.1	BIC <BIC>	142
2.224	Purpose <Purp>	142
2.225	Code <Cd>	143
2.234	RemittanceInformation <RmtInf>	143
2.235	Unstructured <Ustrd>	144
2.236	Structured <Strd>	144
2.256	CreditorReferenceInformation <CdtrRefInf>	145
2.257	Type <Tp>	145
2.258	CodeOrProprietary <CdOrPrtry>	146
2.259	<Cd>	146

2.261	Issuer <Issr>.....	146
2.262	Reference <Ref> .....	147
2.266	RelatedDates <RltdDts>.....	147
2.267	AcceptanceDateTime <AcptncDtTm> .....	148
2.273	TransactionDateTime <TxDtTm> .....	148
2.292	Tax <Tax> .....	148
13.1.15	TotalTaxAmount <TtlTaxAmt> .....	149
13.1.18	Record <Rcrd> .....	150
13.1.19	Type <Tp>.....	150
13.1.31	TaxAmount <TaxAmt> .....	151
13.1.32	Rate <Rate> .....	151
13.1.33	TaxableBaseAmount <TaxblBaseAmt> .....	152
13.1.34	TotalAmount <TtlAmt>.....	153
2.293	ReturnInformation <RtrInf> .....	154
2.294	OriginalBankTransactionCode <OrgnlBkTxCd>.....	155
2.295	Domain <Domn> .....	156
2.296	Code <Cd>.....	156
2.297	Family <Fmly>.....	156
2.298	Code <Cd>.....	157
2.299	SubFamilyCode <SubFmlyCd> .....	157
2.300	Proprietary <Prtry> .....	157
2.301	Code <Cd>.....	158
2.302	Issuer <Issr>.....	158
2.303	Originator <Orgtr> .....	158
9.1.0	Name <Nm> .....	159
2.304	Reason <Rsn>.....	159
2.305	Code <Cd>.....	160
2.307	AdditionalInformation <AddtlInf> .....	161
2.313	AdditionalTransactionInformation <AddtlTxInf> .....	161
2.314	AdditionalEntryInformation <AddtlNtryInf> .....	161
2.315	AdditionalStatementInformation <AddtlStmntInf>.....	161
4.	Principles governing the structure of reporting .....	162
4.1	General principles .....	162
4.1.1.	Information registered under the 'Entry' item – 2.76 : .....	162
4.1.2.	Information registered under the 'Entry details' item – 2.135 : .....	162
4.1.3.	Partial / gross amounts versus net amount : .....	163
4.2.	Reporting of Structured Creditor References to RemittanceInformation - 2.234 Item : .....	163
4.3.	Reporting of Structured Bank References : .....	164
4.4	Reporting of costs, fees and taxes : .....	165
4.5.	Reporting of Customer References from Pain-messages : .....	167
4.6.	Reporting of the different kinds of amounts: .....	169
4.7.	Reporting of the TransactionsSummary – 2.43 item: .....	170
4.8.	Miscellaneous .....	170
4.8.1.	Separate files-messages .....	170
4.8.2.	Splitting up of messages .....	171
4.8.3.	Specific encoding for Belgium : .....	171
5.	Bank Transaction Codes .....	172
5.1.	BkTxCd structure under Camt053.001.02.....	172
5.2.	Double encoding .....	173
5.2.1.	ISO Bank Transaction codes.....	173
5.2.2.	BBA Bank Transaction Code .....	173

6. Appendix.....	174
6.1. Family and Transaction Codes.....	174
6.2. Category Codes .....	199
7. Examples .....	202
7.1. XMLHeader.....	202
7.2. GroupHeader .....	202
7.3. Statement .....	203
7.4. Entries .....	205
7.4.1. SCT Transfer - single .....	205
7.4.2. International transfers - collective .....	206
7.4.3. Charges, Fees and Taxes .....	212
7.4.4. Interests .....	214
7.4.5. Direct Debit (DOM'80) - credit .....	215
7.4.6. Unpaid direct debits (DOM'80) .....	218
7.4.7. Received payments with a Structured Creditor Reference .....	222
7.4.8. Direct Debits (SDD).....	226
7.4.9. Unpaid Direct Debits (SDD).....	228
7.4.10. Taxes on charges .....	230
8. Document version changes .....	232
8.1. Version 2.0 – 03/03/2015 .....	232



## 1. Introduction

This document contains the Belgian guidelines for the application of the Belgian subset of the MX.CAMT.053 B2C Statement.

These application guidelines should make it easier to use the message for the purpose of automatic processing of these data records.

These guidelines have been laid down by the Belgian Financial Sector Federation (Febelfin).

This publication has been prepared with the utmost care in order to offer a maximum guarantee as for the exactness of the information it contains. However, Febelfin cannot be held liable, in whatever way, for any loss or damage which occurs due to incorrect or incomplete information in this document.

This publication is only available in English.

Please contact your bank for more information about the contents of this document.

### A.1. Scope

This message is sent by the bank to an account holder or a third person mandated by him. It is used for informing the account holder or the third person mandated of the account balances and account transactions.

### A.2. General principles

#### A.2.1. Contents of the message :

- The message can hold the reporting on one or more accounts.
- The contents of the message will be limited to information about the transactions that have been entered into bookkeeping
- Reporting will be done in the account currency. Any transaction in another currency first will be converted into the account currency.
- Reporting as for the transactions that have been entered into bookkeeping, will be carried out through MX camt053.001.02 BankToCustomerStatementV02
- The message can be split up into several messages depending on the volume of data to be transferred.

#### A.2.2. Periodicity of the message

- As a matter of principle, a message will be created each bank working day when transactions are taking place. Exceptionally, this may also be the case on a day without any transactions (empty message).
- It will be possible for some banks to send a message, at their customers' request, which contains the reporting as for different dates (on a weekly, monthly, ... basis).

#### A.2.3. Transactions encoding

- The principle has been adopted for double encoding, i.e. encoding proper to ISO Bank Transaction Code list (§ 5.2 – Double encoding ) together with 'proprietary' Febelfin encoding.

#### A.2.4. Globalisation of transactions

- This principle has been adopted for ‘customer’ globalisations (e.g. a data record for invoicing or a data record for the payment of salaries or for paying suppliers for which a single amount is credited or debited to the customer ) as well as for ‘bank’ globalisations, e.g. the total amount of a series of money transfers with structured communication.

#### A.2.5. Reporting of structured communications

- Reporting of creditor structured reference communications generated by the beneficiary of the payments will be done through Message Items specifically used for that purpose (see 4.2).

### A.3. Use of these guidelines

Each item of the BankToCustomer Cash Management Standards message is referring to the corresponding index of the item in the (ISO 20022) Message Definition Report for Bank-to-Customer Cash Management. This Report can be found on [www.iso20022.org](http://www.iso20022.org), under “Catalogue of UNIFI messages”, with “camt.053.001.02” as reference for the EoD reporting.

Any gaps in the index numbering are due to the fact that some message elements of the MX.CAMT.053.001.02 message are not supported in the Belgian subset.

**Message elements not described in these guidelines must not be supported.**

The description of each message item contains :

Index	Number referring to the corresponding description in the MX.CAMT053.001.02 Message Definition Report for Bank-to-Customer Cash Management Statements.
Definition	This contains the definition of the message set or element.
Usage / BBA usage	Additional info on how this element must be used.
XML Tag	Short name identifying an element within an XML message, which is put between brackets, e.g. <Ntry>.
Presence	<p>This shows if an element is optional or obligatory as well as the number of times it can be repeated. The occurrence is mentioned between square brackets.</p> <p>For example :</p> <p>[0..1] indicates that the element can occur 0 times or 1 time. The element is optional.</p> <p>[1..1] indicates that the element must not occur more than once. The element is obligatory.</p> <p>[1..n] indicates that the element is obligatory and can occur between 1 and n times</p> <p>An element which is part of a set of elements is obligatory, in so far as the set it is part of, is mentioned in the message. If only one element among others may be present, this will be indicated by {OR ...OR} in front of the elements concerned</p>
Format	Specification of the values and format allowed
Rules	Any specific rules which could have an impact on the presence or the values of an element.

## A.4. Message structure

### **XML Schemes :**

The description of the UNIFI document models can be found in a number of schemes. A specific description language (XSD) is used in those schemes. The schemes make it possible to give a description of the tags in the document, the structure and sequence of those beacons (hierarchy of tags) as well as the codes which are allowed for some specific data, the number of possible cases, the obligatory or optional character of some of the data, etc.

The general XSD for camt.053.001.02 and for camt.052.001.02 can be found on [www.iso20022.org](http://www.iso20022.org) > Catalogue of UNIFI Messages > Payments > cash Management >

A data record which contains an XML camt.053.001.02 message has the following structure:

```
<?xml version = "1.0" encoding = "UTF-8"?>
    <Document xmlns = "urn:iso:std:iso:20022:tech:xsd:camt.053.001.02"
xmlns:xsi = "http://www.w3.org/2001/XMLSchema-instance">
        <camt.053.001.02>
            message contained...
        </camt.053.001.02>
    </Document>
```

### **MX.CAMT.053 sets**

The message described in this document (Camt.053.001.02) consists of the following sets :

- A. **Group Header** : this is an obligatory block which occurs only once. It contains information proper to the message (identification, creation date, addressee)
- B. **Statement** : this block is obligatory and occurs more than once. It will be repeated as many times as there are different accounts and/or dates in that particular message. This set contains information pertaining to the balances and the transactions.

At the request of their customers, some banks will have the possibility of generating messages with the following characteristics :

- a message for one account for one bank working date. This message will contain a GroupHeader-block and one Statement-block :

GroupHeader
Statment Account 1 Date 1

- a message for several accounts for one bank working date. This message will contain a GroupHeader-block and for each account one Statement-block :

GroupHeader
Statment Account 1 Date 1
Statment Account 2 Date 1
Statment Account 3 Date 1

- a message for one account for several bank working dates. This message will contain a GroupHeader-block and for each bank working date one Statement-block :

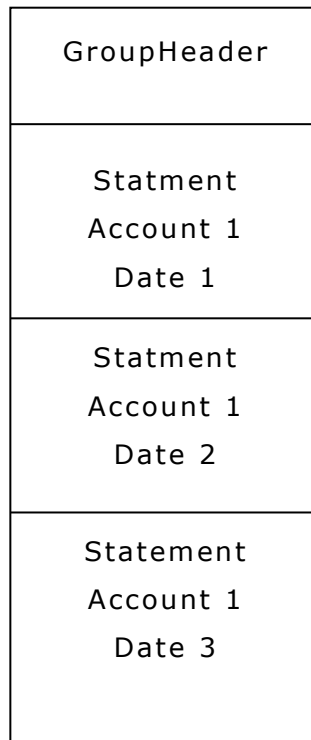

- a message for several accounts for several bank working dates. This message will contain a GroupHeader-block and for each account for each bank working date one Statement-block :

GroupHeader
Statment Account 1 Date 1
Statment Account 1 Date 2
Statment Account 2 Date 1
Statment Account 2 Date 2

## 2. Message Structure

Note :the index numbering in the table below is a copy of the numbering in the (ISO 20022) Message Definition Report – MX camt.053.001.02 BankToCustomerStatementV01” document.

Index	Long Name	L.	Or	Pres.	Rule	Tag Name
<b>1.0</b>	<b>+ GroupHeader</b>	1		[1..1]	<b>TAG</b>	<b>GrpHdr</b>
1.1	++ MessageIdentification	2		[1..1]	string   minLength: 1 maxLength: 35	MsgId
1.2	++ CreationDateTime	2		[1..1]	dateTime	CreDtTm
1.3	++ MessageRecipient	2		[0..1]	TAG	MsgRcpt
9.1.0	+++ Name	3		[0..1]	string   minLength: 1 maxLength: 70	Nm
1.4	++ MessagePagination	2		[0..1]	TAG	MsgPgntn
8.2.0	+++ PageNumber	3		[1..1]	string   pattern: [0-9]{1,5}	PgNb
8.2.1	+++ LastPageIndicator	3		[1..1]	boolean	LastPgInd
1.5	++ AdditionalInformation	2		[0..1]	string   minLength: 1 maxLength: 500	AddtlInf
<b>2.0</b>	<b>+ Statement</b>	1		[1..n]	<b>TAG</b>	<b>Stmt</b>
2.1	++ Identification	2		[1..1]	string   minLength: 1 maxLength: 35	Id
2.2	++ ElectronicSequenceNumber	2		[0..1]	decimal   fractionDigits: 0 totalDigits: 18	ElctrncSeqNb
2.3	++ LegalSequenceNumber	2		[0..1]	decimal   fractionDigits: 0 totalDigits: 18	LglSeqNb
2.4	++ CreationDateTime	2		[1..1]	dateTime	CreDtTm
2.5	++ FromToDate	2		[0..1]	TAG	FrToDt
5.1.0	+++ FromDateTime	3		[1..1]	dateTime	FrDtTm
5.1.1	+++ ToDateTime	3		[1..1]	dateTime	ToDtTm
2.6	++ CopyDuplicateIndicator	2		[0..1]	string   enumeration: CODU COPY DUPL	CpyDplctInd
2.10	++ Account	2		[1..1]	TAG	Acct
1.2.0	+++ Identification	3		[1..1]	TAG	Id
1.2.1	++++ IBAN	4	{Or	[1..1]	string   pattern: [a-zA-Z]{2,2}[0-9]{2,2}[a-zA-Z0-9]{1,30}	IBAN
1.2.2	++++ Other	4	Or}	[1..1]	TAG	Othr
1.2.3	+++++ Identification	5		[1..1]	Max34Text	Id
1.2.8	+++ Type	3		[0..1]	string   enumeration:	Tp
1.2.10	++++ Proprietary	4		[1..1]	string   minLength: 1 maxLength: 35	Prtry
1.2.11	+++ Currency	3		[0..1]	string   pattern: [A-Z]{3,3}	Ccy
1.2.12	+++ Name	3		[0..1]	string   minLength: 1 maxLength: 70	Nm
1.2.13	+++ Owner	3		[0..1]	TAG	Ownr
1.2.14	++++ Name	4		[0..1]	string   minLength: 1 maxLength: 70	Nm
1.2.26	+++++ Identification	4		[0..1]	TAG	Id
1.2.27	+++++ OrganisationIdentification	5		[1..1]	TAG	OrgId
1.2.29	+++++ Other	6		[0..n]	TAG	Othr

1.2.30		+++++++ Identification	7		[1..1]	string   minLength: 1 maxLength: 35	Id
1.2.56		+++ Servicer	3		[0..1]	TAG	Svcr
1.2.57		++++ FinancialInstitutionIdentification	4		[1..1]	TAG	FinInstnId
1.2.58		+++++ BIC	5		[1..1]	string   pattern: [A-Z]{6,6}[A-Z2-9][A-NP-Z0-9]([A-Z0-9]{3,3}){0,1}	BIC
2.11		++ RelatedAccount	2		[0..1]	TAG	RltdAcct
1.1.0		+++ Identification	3		[1..1]	TAG	Id
1.1.1		++++ IBAN	4	{Or	[1..1]	string   pattern: [a-zA-Z]{2,2}[0-9]{2,2}[a-zA-Z0-9]{1,30}	IBAN
1.1.2		++++ Other	4	Or}	[1..1]	TAG	Othr
1.1.3		+++++ Identification	5		[1..1]	Max34Text	Id
2.23		++ Balance	2		[1..n]	TAG	Bal
2.24		+++ Type	3		[1..1]	TAG	Tp
2.25		++++ CodeOrProprietary	4		[1..1]	TAG	CdOrPrtry
2.26		+++++ Code	5	{Or	[1..1]	string   enumeration cfr Message Item Description	Cd
2.27		+++++ Proprietary	5	Or}	[1..1]	string   minLength: 1 maxLength: 35	Prtry
2.28		++++ subType	4		[0..1]	TAG	SubTp
2.29		+++++ Code	5	{Or	[1..1]	string   enumeration cfr Message Item Description	Cd
2.34		+++ Amount	3		[1..1]	decimal   minInclusive: 0 fractionDigits: 5 totalDigits: 18 Attribute   Ccy: required	Amt
2.35		+++ CreditDebitIndicator	3		[1..1]	string   enumeration: cfr Message Item Description	CdtDbtInd
2.36		+++ Date	3		[1..1]	TAG	Dt
4.1.0		++++ Date	4		[1..1]	date	Dt
2.43		++ TransactionsSummary	2		[0..1]	TAG	TxsSummry
2.44		+++ TotalEntries	3		[0..1]	TAG	TtlNtries
2.45		++++ NumberOfEntries	4		[0..1]	string   pattern: [0-9]{1,15}	NbOfNtries
2.46		++++ Sum	4		[0..1]	decimal   fractionDigits: 17 totalDigits: 18	Sum
2.47		++++ TotalNetEntryAmount	4		[0..1]	decimal   fractionDigits: 17 totalDigits: 18	TtlNetNtryAm t
2.48		++++ CreditDebitIndicator	4		[0..1]	string   enumeration: cfr Message Item Description	CdtDbtInd
2.49		+++ TotalCreditEntries	3		[0..1]	TAG	TtlCdtNtries
2.50		++++ NumberOfEntries	4		[0..1]	string   pattern: [0-9]{1,15}	NbOfNtries
2.51		++++ Sum	4		[0..1]	decimal   fractionDigits: 17 totalDigits: 18	Sum
2.52		+++ TotalDebitEntries	3		[0..1]	TAG	TtlDbtNtries
2.53		++++ NumberOfEntries	4		[0..1]	string   pattern: [0-9]{1,15}	NbOfNtries
2.54		++++ Sum	4		[0..1]	decimal   fractionDigits: 17 totalDigits: 18	Sum
2.76		++ Entry	2		[0..n]	TAG	Ntry



2.77		+++ EntryReference	3		[0..1]	string   minLength: 1 maxLength: 35	NtryRef
2.78		+++ Amount	3		[1..1]	decimal   minInclusive: 0 fractionDigits: 5 totalDigits: 18 Attribute   Ccy: required	Amt
2.79		+++ CreditDebitIndicator	3		[1..1]	string   enumeration: cfr Message Item Description	CdtDbtInd
2.80		+++ ReversalIndicator	3		[0..1]	boolean	RvslInd
2.81		+++ Status	3		[1..1]	string   enumeration: BOOK	Sts
2.82		+++ BookingDate	3		[0..1]	TAG	BookgDt
4.1.0		++++ Date	4		[1..1]	date	Dt
2.83		+++ ValueDate	3		[0..1]	TAG	ValDt
4.1.0		++++ Date	4		[1..1]	date	Dt
2.84		+++ AccountServicerReference	3		[0..1]	string   minLength: 1 maxLength: 35	AcctSvcrRef
2.91		+++ BankTransactionCode	3		[1..1]	TAG	BkTxCd
2.92		++++ Domain	4		[0..1]	TAG	Domn
2.93		+++++ Code	5		[1..1]	string   minLength: 1 maxLength: 4	Cd
2.94		+++++ Family	5		[1..1]	TAG	Fmly
2.95		+++++ Code	6		[1..1]	string   minLength: 1 maxLength: 4	Cd
2.96		+++++ SubFamilyCode	6		[1..1]	string   minLength: 1 maxLength: 4	SubFmlyCd
2.97		++++ Proprietary	4		[0..1]	TAG	Prtry
2.98		+++++ Code	5		[1..1]	string   minLength: 1 maxLength: 35	Cd
2.99		+++++ Issuer	5		[0..1]	string   minLength: 1 maxLength: 35	Issr
2.101		+++ AdditionalInformationIndicator	3		[0..1]	string   minLength: 1 maxLength: 35	AddtlInflnd
2.102		++++ MessageNameIdentification	4		[0..1]	string   minLength: 1 maxLength: 35	MsgNmId
2.103		++++ MessageIdentification	4		[0..1]	string   minLength: 1 maxLength: 35	MsgId
2.104		+++ AmountDetails	3		[0..1]	TAG	AmtDtls
2.1.0		++++ InstructedAmount	4		[0..1]	TAG	InstdAmt
2.1.1		+++++ Amount	5		[1..1]	decimal   minInclusive: 0 fractionDigits: 5 totalDigits: 18 Attribute   Ccy: required	Amt
2.1.9		++++ TransactionAmount	4		[0..1]	TAG	TxAmt
2.1.10		+++++ Amount	5		[1..1]	decimal   minInclusive: 0 fractionDigits: 5 totalDigits: 18 Attribute   Ccy: required	Amt
2.1.18		++++ CounterValueAmount	4		[0..1]	TAG	CntrValAmt
2.1.19		+++++ Amount	5		[1..1]	decimal   minInclusive: 0 fractionDigits: 5 totalDigits: 18 Attribute   Ccy: required	Amt
2.1.20		+++++ CurrencyExchange	5		[0..1]	TAG	CcyXchg
2.1.21		+++++ SourceCurrency	6		[1..1]	string   pattern: [A-Z]{3,3}	SrcCcy
2.1.22		+++++ TargetCurrency	6		[0..1]	string   pattern: [A-Z]{3,3}	TrgtCcy
2.1.23		+++++ UnitCurrency	6		[0..1]	string   pattern: [A-Z]{3,3}	UnitCcy
2.1.24		+++++ ExchangeRate	6		[1..1]	decimal   fractionDigits: 10 totalDigits: 11	XchgRate

2.1.36		++++ ProprietaryAmount	4		[0..1]	TAG	PrtryAmt
2.1.37		+++++ Type	5		[1..1]	string   minLength: 1 maxLength: 35	Tp
2.1.38		+++++ Amount	5		[1..1]	decimal   minInclusive: 0 fractionDigits: 5 totalDigits: 18 Attribute   Ccy: required	Amt
2.105		+++ Charges	3		[0..n]	TAG	Chrgs
2.107		++++ Amount	4		[1..1]	decimal   minInclusive: 0 fractionDigits: 5 totalDigits: 18 Attribute   Ccy: required	Amt
2.108		++++ CreditDebitIndicator	4		[0..1]	string   enumeration: cfr Message Item Description	CdtDbtInd
2.109		++++ Type	4		[0..1]	TAG	Tp
2.111		+++++ Proprietary	5		[1..1]	string   pattern: [a-zA-Z0-9]{1,4}	Prtry
7.1.0		++++++ Identification	6		[1..1]	string   minLength: 1 maxLength: 35	Id
7.1.1		++++++ Issuer	6		[0..1]	string   minLength: 1 maxLength: 35	Issr
2.112		++++ Rate	4		[0..1]	decimal   fractionDigits: 10 totalDigits: 11	Rate
2.115		++++ Tax	4		[0..1]	TAG	Tax
2.116		+++++ Identification	5		[0..1]	string   minLength: 1 maxLength: 35	Id
2.117		+++++ Rate	5		[0..1]	decimal   fractionDigits: 10 totalDigits: 11	Rate
2.118		+++++ Amount	5		[0..1]	decimal   minInclusive: 0 fractionDigits: 5 totalDigits: 18 Attribute   Ccy: required	Amt
2.135		+++ EntryDetails	3		[0..n]	TAG	NtryDtIs
2.136		++++ Batch	4		[0..1]	TAG	Btch
2.137		+++++ MessageIdentification	5		[0..1]	string   minLength: 1 maxLength: 35	MsgId
2.138		+++++ PaymentInformationIdentification	5		[0..1]	string   minLength: 1 maxLength: 35	PmtInfId
2.139		+++++ NumberOfTransactions	5		[0..1]	string   pattern: [0-9]{1,15}	NbOfTxs
2.140		+++++ TotalAmount	5		[0..1]	decimal   minInclusive: 0 fractionDigits: 5 totalDigits: 18 Attribute   Ccy: required	TtlAmt
2.141		+++++ CreditDebitIndicator	5		[0..1]	string   enumeration: cfr Message Item Description	CdtDbtInd
2.142		++++ TransactionDetails	4		[0..n]	TAG	TxDtIs
2.143		+++++ References	5		[0..1]	TAG	Refs
2.144		++++++ MessageIdentification	6		[0..1]	string   minLength: 1 maxLength: 35	MsgId
2.145		++++++ AccountServicerReference	6		[0..1]	string   minLength: 1 maxLength: 35	AcctSvcrRef
2.146		++++++ PaymentInformationIdentification	6		[0..1]	string   minLength: 1 maxLength: 35	PmtInfId
2.147		++++++ InstructionIdentification	6		[0..1]	string   minLength: 1 maxLength: 35	InstrId
2.148		++++++ EndToEndIdentification	6		[0..1]	string   minLength: 1 maxLength: 35	EndToEndId
2.149		++++++ TransactionIdentification	6		[0..1]	string   minLength: 1 maxLength: 35	TxId
2.150		++++++ MandateIdentification	6		[0..1]	string   minLength: 1 maxLength: 35	MndtId

2.151		+++++ ChequeNumber	6		[0..1]	string   minLength: 1 maxLength: 35	ChqNb
2.153		+++++ Proprietary	6		[0..1]	TAG	Prtry
2.154		+++++ Type	7		[1..1]	string   minLength: 1 maxLength: 35	Tp
2.155		+++++ Reference	7		[1..1]	string   minLength: 1 maxLength: 35	Ref
2.156		++++ AmountDetails	5		[0..1]	TAG	AmtDtls
2.1.0		+++++ InstructedAmount	6		[0..1]	TAG	InstdAmt
2.1.1		+++++ Amount	7		[1..1]	decimal   minInclusive: 0 fractionDigits: 5 totalDigits: 18 Attribute   Ccy: required	Amt
2.1.9		+++++ TransactionAmount	6		[0..1]	TAG	TxAmt
2.1.10		+++++ Amount	7		[1..1]	decimal   minInclusive: 0 fractionDigits: 5 totalDigits: 18 Attribute   Ccy: required	Amt
2.1.18		+++++ CounterValueAmount	6		[0..1]	TAG	CntrValAmt
2.1.19		+++++ Amount	7		[1..1]	decimal   minInclusive: 0 fractionDigits: 5 totalDigits: 18 Attribute   Ccy: required	Amt
2.1.20		+++++ CurrencyExchange	7		[0..1]	TAG	CcyXchg
2.1.21		+++++ SourceCurrency	8		[1..1]	string   pattern: [A-Z]{3,3}	SrcCcy
2.1.22		+++++ TargetCurrency	8		[0..1]	string   pattern: [A-Z]{3,3}	TrgtCcy
2.1.23		+++++ UnitCurrency	8		[0..1]	string   pattern: [A-Z]{3,3}	UnitCcy
2.1.24		+++++ ExchangeRate	8		[1..1]	decimal   fractionDigits: 10 totalDigits: 11	XchgRate
2.1.36		+++++ ProprietaryAmount	6		[0..1]	TAG	PrtryAmt
2.1.37		+++++ Type	7		[1..1]	string   minLength: 1 maxLength: 35	Tp
2.1.38		+++++ Amount	7		[1..1]	decimal   minInclusive: 0 fractionDigits: 5 totalDigits: 18 Attribute   Ccy: required	Amt
2.163		++++ BankTransactionCode	5		[0..1]	TAG	BkTxCd
2.164		+++++ Domain	6		[0..1]	TAG	Domn
2.165		+++++ Code	7		[1..1]	string   minLength: 1 maxLength: 4	Cd
2.166		+++++ Family	7		[1..1]	TAG	Fmly
2.167		+++++ Code	8		[1..1]	string   minLength: 1 maxLength: 4	Cd
2.168		+++++ SubFamilyCode	8		[1..1]	string   minLength: 1 maxLength: 4	SubFmlyCd
2.169		+++++ Proprietary	6		[0..1]	TAG	Prtry
2.170		+++++ Code	7		[1..1]	string   minLength: 1 maxLength: 35	Cd
2.171		+++++ Issuer	7		[0..1]	string   minLength: 1 maxLength: 35	Issr
2.172		++++ Charges	5		[0..n]	TAG	Chrgs
2.174		+++++ Amount	6		[1..1]	decimal   minInclusive: 0 fractionDigits: 5 totalDigits: 18 Attribute   Ccy: required	Amt
2.175		+++++ CreditDebitIndicator	6		[0..1]	string   enumeration: cfr Message Item Description	CdtDbtInd
2.176		+++++ Type	6		[0..1]	TAG	Tp
2.178		+++++ Proprietary	7		[1..1]	TAG	Prtry

7.1.0		+++++++ Identification	8		[1..1]	string   minLength: 1 maxLength: 35	Id
7.1.1		+++++++ Issuer	8		[0..1]	string   minLength: 1 maxLength: 35	Issr
2.179		+++++ Rate	6		[0..1]	decimal   fractionDigits: 10 totalDigits: 11	Rate
2.182		+++++ Tax	6		[0..1]	TAG	Tax
2.183		+++++++ Identification	7		[0..1]	string   minLength: 1 maxLength: 35	Id
2.184		+++++++ Rate	7		[0..1]	decimal   fractionDigits: 10 totalDigits: 11	Rate
2.185		+++++++ Amount	7		[0..1]	decimal   minInclusive: 0 fractionDigits: 5 totalDigits: 18 Attribute   Ccy: required	Amt
2.186		+++++ Interest	5		[0..n]	TAG	Intrst
2.187		+++++ Amount	6		[1..1]	decimal   minInclusive: 0 fractionDigits: 5 totalDigits: 18 Attribute   Ccy: required	Amt
2.188		+++++ CreditDebitIndicator	6		[1..1]	string   enumeration: CRDT DBIT	CdtDbtInd
2.189		+++++ Type	6		[0..1]	TAG	Tp
2.191		+++++++ Proprietary	7		[1..1]	string   minLength: 1 maxLength: 35 totalDigits: 11	Prtry
2.192		+++++ Rate	6		[0..n]	TAG	Rate
2.193		+++++++ Type	7		[1..1]	TAG	Tp
2.194		+++++++ Percentage	8	{Or	[1..1]	PercentageRate   fractionDigits: 10	Pctg
2.195		+++++++ Other	8	Or}	[1..1]	string   minLength: 1 maxLength: 35	Othr
2.197		+++++ FromToDate	6		[0..1]	TAG	FrToDt
5.1.0		+++++++ FromDateTime	7		[1..1]	dateTime	FrDtTm
5.1.1		+++++++ ToDateTime	7		[1..1]	dateTime	ToDtTm
2.199		+++++ RelatedParties	5		[0..1]	TAG	RltdPties
2.200		+++++ InitiatingParty	6		[0..1]	TAG	InitgPty
9.1.0		+++++++ Name	7		[0..1]	string   minLength: 1 maxLength: 70	Nm
9.1.1		+++++++ PostalAddress	7		[0..1]	TAG	PstlAdr
9.1.5		+++++++ StreetName	8		[0..1]	string   minLength: 1 maxLength: 70	StrtNm
9.1.6		+++++++ BuildingNumber	8		[0..1]	string   minLength: 1 maxLength: 16	BldgNb
9.1.7		+++++++ PostalCode	8		[0..1]	string   minLength: 1 maxLength: 16	PstCd
9.1.8		+++++++ Townname	8		[0..1]	string   minLength: 1 maxLength: 35	TwnNm
9.1.10		+++++++ Country	8		[0..1]	string   pattern: [A-Z]{2,2}	Ctry
9.1.11		+++++++ AddressLine	8		[0..7]	string   minLength: 1 maxLength: 70	AdrLine
2.201		+++++ Debtor	6		[0..1]	TAG	Dbtr
9.1.0		+++++++ Name	7		[0..1]	string   minLength: 1 maxLength: 70	Nm
9.1.1		+++++++ PostalAddress	7		[0..1]	TAG	PstlAdr
9.1.5		+++++++ StreetName	8		[0..1]	string   minLength: 1 maxLength: 70	StrtNm

9.1.6		+++++++ BuildingNumber	8		[0..1]	string   minLength: 1 maxLength: 16	BldgNb
9.1.7		+++++++ PostalCode	8		[0..1]	string   minLength: 1 maxLength: 16	PstCd
9.1.8		+++++++ Townname	8		[0..1]	string   minLength: 1 maxLength: 35	TwnNm
9.1.10		+++++++ Country	8		[0..1]	string   pattern: [A-Z]{2,2}	Ctry
9.1.11		+++++++ AddressLine	8		[0..7]	string   minLength: 1 maxLength: 70	AdrLine
9.1.12		+++++++ Identification	7		[0..1]	TAG	Id
9.1.13		+++++++ OrganisationIdentification	8		[1..1]	TAG	OrgId
9.1.14		+++++++ BICOrBEI	9		[0..1]	string   pattern: [A-Z]{6,6}[A-Z2-9][A-NP-Z0-9]([A-Z0-9]{3,3}){0,1}	BICOrBEI
2.202		+++++++ DebtorAccount	6		[0..1]	TAG	DbtrAcct
1.1.0		+++++++ Identification	7		[1..1]	TAG	Id
1.1.1		+++++++ IBAN	8	{Or	[1..1]	string   pattern: [a-zA-Z]{2,2}[0-9]{2,2}[a-zA-Z0-9]{1,30}	IBAN
1.1.2		+++++++ Other	8	Or}	[1..1]	TAG	Othr
1.1.3		+++++++ Identification	9		[1..1]	Max34Text	Id
1.1.7		+++++++ Issuer	8		[0..1]	Max35Text	Issr
2.203		+++++++ UltimateDebtor	6		[0..1]	TAG	UltmtDbtr
9.1.0		+++++++ Name	7		[0..1]	string   minLength: 1 maxLength: 70	Nm
9.1.1		+++++++ PostalAddress	7		[0..1]	TAG	PstIAdr
9.1.5		+++++++ StreetName	8		[0..1]	string   minLength: 1 maxLength: 70	StrtNm
9.1.6		+++++++ BuildingNumber	8		[0..1]	string   minLength: 1 maxLength: 16	BldgNb
9.1.7		+++++++ PostalCode	8		[0..1]	string   minLength: 1 maxLength: 16	PstCd
9.1.8		+++++++ Townname	8		[0..1]	string   minLength: 1 maxLength: 35	TwnNm
9.1.10		+++++++ Country	8		[0..1]	string   pattern: [A-Z]{2,2}	Ctry
9.1.11		+++++++ AddressLine	8		[0..7]	string   minLength: 1 maxLength: 70	AdrLine
9.1.12		+++++++ Identification	7		[0..1]	TAG	Id
9.1.13		+++++++ OrganisationIdentification	8		[1..1]	TAG	OrgId
9.1.14		+++++++ BICOrBEI	9		[0..1]	string   pattern: [A-Z]{6,6}[A-Z2-9][A-NP-Z0-9]([A-Z0-9]{3,3}){0,1}	BICOrBEI
9.1.15		+++++++ Other	9		[0..n]	TAG	Othr
9.1.16		+++++++ Identification	10		[1..1]	string   minLength: 1 maxLength: 35	Id
2.204		+++++++ Creditor	6		[0..1]	TAG	Cdtr
9.1.0		+++++++ Name	7		[0..1]	string   minLength: 1 maxLength: 70	Nm
9.1.1		+++++++ PostalAddress	7		[0..1]	TAG	PstIAdr
9.1.5		+++++++ StreetName	8		[0..1]	string   minLength: 1 maxLength: 70	StrtNm

9.1.6		+++++++ BuildingNumber	8		[0..1]	string   minLength: 1 maxLength: 16	BldgNb
9.1.7		+++++++ PostalCode	8		[0..1]	string   minLength: 1 maxLength: 16	PstCd
9.1.8		+++++++ Townname	8		[0..1]	string   minLength: 1 maxLength: 35	TwnNm
9.1.10		+++++++ Country	8		[0..1]	string   pattern: [A-Z]{2,2}	Ctry
9.1.11		+++++++ AddressLine	8		[0..7]	string   minLength: 1 maxLength: 70	AdrLine
9.1.12		+++++ Identification	7		[0..1]	TAG	Id
9.1.13		+++++++ OrganisationIdentification	8		[1..1]	TAG	OrgId
9.1.14		+++++++ BICOrBEI	9		[0..1]	string   pattern: [A-Z]{6,6}[A-Z2-9][A-NP-Z0-9]([A-Z0-9]{3,3}){0,1}	BICOrBEI
9.1.15		+++++++ Other	9		[0..n]	TAG	Othr
9.1.16		+++++++ Identification	10		[1..1]	string   minLength: 1 maxLength: 35	Id
2.205		+++++ CreditorAccount	6		[0..1]	TAG	CdtrAcct
1.1.0		+++++ Identification	7		[1..1]	TAG	Id
1.1.1		+++++++ IBAN	8	{Or	[1..1]	string   pattern: [a-zA-Z]{2,2}[0-9]{2,2}[a-zA-Z0-9]{1,30}	IBAN
1.1.2		+++++++ Other	8	Or}	[1..1]	TAG	Othr
1.1.3		+++++++ Identification	9		[1..1]	Max34Text	Id
1.1.7		+++++++ Issuer	8		[0..1]	Max35Text	Issr
2.206		+++++ UltimateCreditor	6		[0..1]	TAG	UltmtCdtr
9.1.0		+++++++ Name	7		[0..1]	string   minLength: 1 maxLength: 70	Nm
9.1.1		+++++++ PostalAddress	7		[0..1]	TAG	PstIAdr
9.1.5		+++++++ StreetName	8		[0..1]	string   minLength: 1 maxLength: 70	StrtNm
9.1.6		+++++++ BuildingNumber	8		[0..1]	string   minLength: 1 maxLength: 16	BldgNb
9.1.7		+++++++ PostalCode	8		[0..1]	string   minLength: 1 maxLength: 16	PstCd
9.1.8		+++++++ Townname	8		[0..1]	string   minLength: 1 maxLength: 35	TwnNm
9.1.10		+++++++ Country	8		[0..1]	string   pattern: [A-Z]{2,2}	Ctry
9.1.11		+++++++ AddressLine	8		[0..7]	string   minLength: 1 maxLength: 70	AdrLine
9.1.12		+++++ Identification	7		[0..1]	TAG	Id
9.1.13		+++++++ OrganisationIdentification	8		[1..1]	TAG	OrgId
9.1.14		+++++++ BICOrBEI	9		[0..1]	string   pattern: [A-Z]{6,6}[A-Z2-9][A-NP-Z0-9]([A-Z0-9]{3,3}){0,1}	BICOrBEI
9.1.15		+++++++ Other	9		[0..n]	TAG	Othr
9.1.16		+++++++ Identification	10		[1..1]	string   minLength: 1 maxLength: 35	Id
2.211		+++++ RelatedAgents	5		[0..1]	TAG	RItdAgts
2.212		+++++ DebtorAgent	6		[0..1]	TAG	DbtrAgt
6.1.0		+++++++ FinancialInstitutionIdentification	7		[1..1]	TAG	FinInstnId

6.1.1		+++++++ BIC	8		[0..1]	string   pattern: [A-Z]{6,6}[A-Z2-9][A-NP-Z0-9]([A-Z0-9]{3,3}){0,1}	BIC
2.213		+++++ CreditorAgent	6		[0..1]	TAG	<CdrAgt>
6.1.0		+++++++ FinancialInstitutionIdentification	7		[1..1]	TAG	FinInstnId
6.1.1		+++++++ BIC	8		[0..1]	string   pattern: [A-Z]{6,6}[A-Z2-9][A-NP-Z0-9]([A-Z0-9]{3,3}){0,1}	BIC
2.224		+++++ Purpose	5		[0..1]	TAG	Purp
2.225		+++++ Code	6		[1..1]	string   minLength: 1 maxLength: 4	Cd
2.234		+++++ RemittanceInformation	5		[0..1]	TAG	RmtInf
2.235		+++++ Unstructured	6		[0..n]	string   minLength: 1 maxLength: 140	Ustrd
2.236		+++++ Structured	6		[0..n]	TAG	Strd
2.256		+++++++ CreditorReferenceInformation	7		[0..1]	TAG	CdrRefInf
2.257		+++++++ Type	8		[0..1]	TAG	Tp
2.258		+++++++ CodeOrProprietary	9		[1..1]	TAG	CdOrPrtry
2.259		+++++++ Code	10		[1..1]	string   enumeration cfr Message Item Description	Cd
2.261		+++++++ Issuer	9		[0..1]	string   minLength: 1 maxLength: 35	Issr
2.262		+++++++ Reference	8		[0..1]	string   minLength: 1 maxLength: 35	Ref
2.266		+++++ RelatedDates	5		[0..1]	TAG	RltdDts
2.267		+++++ AcceptanceDateTime	6		[0..1]	dateTime	AcptncDtTm
2.273		+++++ TransactionDateTime	6		[0..1]	dateTime	TxDtTm
2.292		+++++ Tax	5		[0..1]	TAG	Tax
13.1.1 5		+++++ TotalTaxAmount	6		[0..1]	decimal   minInclusive: 0 fractionDigits: 5 totalDigits: 18 Attribute   Ccy: required	TtlTaxAmt
13.1.1 8		+++++ Record	6		[0..n]	TAG	Rcrd
13.1.1 9		+++++ Type	7		[0..1]	string   minLength: 1 maxLength: 35	Tp
13.1.3 1		+++++ TaxAmount	7		[0..1]		TaxAmt
13.1.3 2		+++++ Rate	8		[0..1]	decimal   fractionDigits: 10 totalDigits: 11	Rate
13.1.3 3		+++++++ TaxableBaseAmount	8		[0..1]	decimal   minInclusive: 0 fractionDigits: 5 totalDigits: 18 Attribute   Ccy: required	TaxblBaseAm t
13.1.3 4		+++++++ TotalAmount	8		[0..1]	decimal   minInclusive: 0 fractionDigits: 5 totalDigits: 18 Attribute   Ccy: required	TtlAmt
2.293		+++++ ReturnInformation	5		[0..1]	TAG	RtrInf
2.294		+++++++ OriginalBankTransactionCode	6		[0..1]	TAG	OrgnIBkTxCd
2.295		+++++++ Domain	7		[0..1]	TAG	Domn
2.296		+++++++ Code	8		[1..1]	string   minLength: 1 maxLength: 4	Cd
2.297		+++++++ Family	8		[1..1]	TAG	Fmly
2.298		+++++++ Code	9		[1..1]	string   minLength: 1 maxLength: 4	Cd

2.299		SubFamilyCode *****	9		[1..1]	string   minLength: 1 maxLength: 4	SubFmlyCd
2.300		***** Proprietary	7		[0..1]	TAG	Prtry
2.301		***** Code	8		[1..1]	string   minLength: 1 maxLength: 35	Cd
2.302		***** Issuer	8		[0..1]	string   minLength: 1 maxLength: 35	Issr
2.303		***** Originator	6		[0..1]	TAG	Orgtr
9.1.0		***** Name	7		[0..1]	string   minLength: 1 maxLength: 70	Nm
2.304		***** Reason	6		[0..1]	TAG	Rsn
2.305		***** Code	7	{Or	[1..1]	string   enumeration cfr Message Item Description	Cd
2.306		***** Proprietary	7	Or}	[1..1]	string   minLength: 1 maxLength: 35	Prtry
2.307		***** AdditionalInformation	6		[0..n]	string   minLength: 1 maxLength: 105	AddtInf
2.313		***** AdditionalTransactionInformation	5		[0..1]	string   minLength: 1 maxLength: 500	AddtTxInf
2.314		+++ AdditionalEntryInformation	3		[0..1]	string   minLength: 1 maxLength: 500	AddtNtryInf
2.315		++ AdditionalStatementInformation	2		[0..1]	string   minLength: 1 maxLength: 500	AddtStmtInf



### 3. Message Item Description

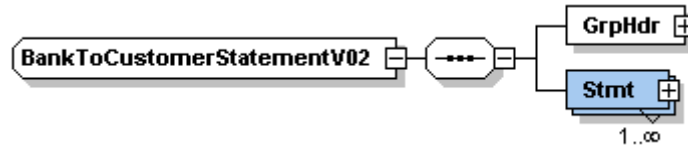

#### 1.0 GroupHeader

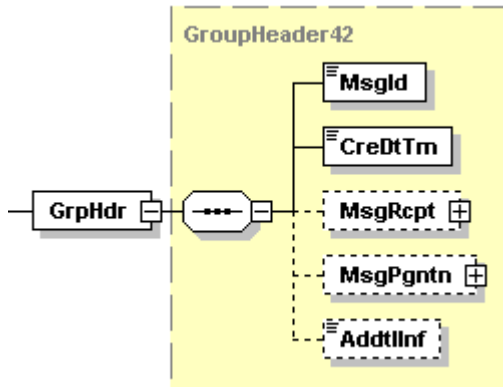

**Presence:** [1..1]

**Definition:** Common information for the message.

**Type:** *The **GroupHeader** block is composed of the following **GroupHeader42** element(s):*

Index	Or	Message Item	<XML Tag>	Mult.	Represent./ Type
<u>1.1</u>		MessageIdentification	<MsgId>	[1..1]	Text
<u>1.2</u>		CreationDateTime	<CreDtTm>	[1..1]	DateTime
<u>1.3</u>		MessageRecipient	<MsgRcpt>	[0..1]	±
<u>1.4</u>		MessagePagination	<MsgPgntn>	[0..1]	±
<u>1.5</u>		AdditionalInformation	<AddtlInf>	[0..1]	Text

## 1.1 MessageIdentification <MsgId>



**Presence:** [1..1]

**Definition:** Point to point reference assigned by the account servicing institution and sent to the account owner to unambiguously identify the message.

**Usage:** The account servicing institution has to make sure that 'MessageIdentification' is unique per instructed party for a pre-agreed period.

**Data Type:** Max35Text

**Format:** maxLength: 35  
minLength: 1

## 1.2 CreationDateTime <CreDtTm>



**Presence:** [1..1]

**Definition:** Date and time at which the message was created.

**Data Type:** ISODateTime

**BBA USAGE :** If it concerns a duplicate message of an earlier message, the date will be that at which the duplicate was created. Consequently, this date may be different from the original date.

## 1.3 MessageRecipient <MsgRcpt>

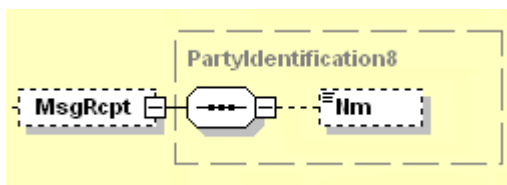

**Presence:** [0..1]

**Definition:** Party authorised by the account owner to receive information about movements on the account.

**Usage:** MessageRecipient should only be identified when different from the account owner.

**Type:** *This message item is composed of the following **PartyIdentification32** element(s):*

### 9.1.0 Name <Nm>



**Presence:** [0..1]

**Definition:** Name by which a party is known and which is usually used to identify that party.

**Data Type:** Max140Text

**Format:** maxLength: 140  
minLength: 1

## 1.4 MessagePagination <MsgPgntn>

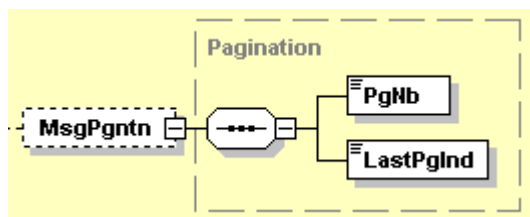

**Presence:** [0..1]

**Definition:** Pagination of the message.

**Usage:** the pagination of the message is only allowed when agreed between the parties.

**Type:** *This message item is composed of the following **Pagination** element(s):*

Ref	Or	Message Item	<XML Tag>	Mult.	Represent./ Type
<a href="#">8.2.0</a>		PageNumber	<PgNb>	[1..1]	Text
<a href="#">8.2.1</a>		LastPageIndicator	<LastPgInd>	[1..1]	Indicator

**BBA USAGE**: depending on the volume of information to be forwarded, it will be possible to split up the message.

- if there is no splitting (one single file), item 8.2.0 always must be completed by «1» and item 8.2.1 by «true».
- some banks may choose not to report the MessagePagination-block in case of no splitting.
- if there is splitting, item 8.2.0 must always be completed by a page number and item 8.2.1 by «false», except for the last page, where item 8.2.1 is «true». In this case, the intermediary balances will be indicated by a keyword «INTM» under item 2.28 <SubTp>.

### 8.2.0 PageNumber <PgNb>

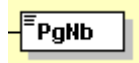

**Presence:** [1..1]  
**Definition:** Page number.  
**Data Type:** Max5NumericText  
**Format:** [0-9]{1,5}

### 8.2.1 LastPageIndicator <LastPgInd>



**Presence:** [1..1]  
**Definition:** Indicates the last page.  
**Data Type:** *One of the following YesNoIndicator values must be used:*  
MeaningWhenTrue: Yes  
MeaningWhenFalse: No

## 1.5 AdditionalInformation <AddtlInf>

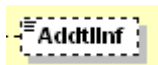

**Presence:** [0..1]  
**Definition:** Further details on the message.  
**Data Type:** Max500Text  
**Format:** maxLength: 500  
minLength: 1

**BBA USAGE** : This item will be completed only for separate messages.  
Each bank will use its own codes.

## 2.0 Statement

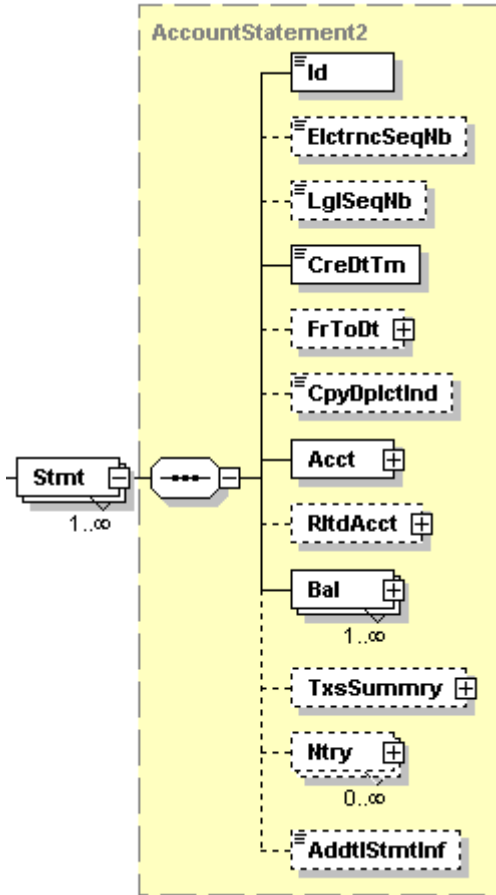

**Presence:** [1..n]

**Definition:** Reports on booked entries and balances for a cash account.

**Type:** *The Statement block is composed of the following AccountStatement1 element(s):*

### 2.1 Identification

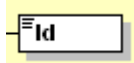

**Presence:** [1..1]

**Definition:** Unique identification, as assigned by the account servicer, to unambiguously identify the account statement.

**Data Type:** Max35Text

**Format:** maxLength: 35  
minLength: 1

## 2.2 ElectronicSequenceNumber <ElctrncSeqNb>

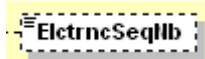

**Presence:** [0..1]

**Definition:** Sequential number of the statement, as assigned by the account servicer.

**Usage:** The sequential number is increased incrementally for each statement sent electronically.

**Data Type:** Number

**Format:** fractionDigits: 0  
totalDigits: 18

## 2.3 LegalSequenceNumber <LglSeqNb>



**Presence:** [0..1]

**Definition:** Legal sequential number of the statement, as assigned by the account servicer. It is increased incrementally for each statement sent.

**Usage:** Where a paper statement is a legal requirement, it may have a number different from the electronic sequential number. Paper statements could for instance only be sent if movement on the account has taken place, whereas electronic statements could be sent at the end of each reporting period, regardless of whether movements have taken place or not.

**Data Type:** Number

**Format:** fractionDigits: 0  
totalDigits: 18

## 2.4 CreationDateTime <CreDtTm>

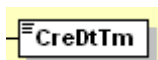

**Presence:** [1..1]

**Definition:** Date and time at which the message was created.

**Data Type:** ISODateTime

**BBA USAGE :** If it concerns a duplicate statement of an earlier statement, the date will be the same as the date at which the original statement was created.

## 2.5 FromToDate <FrToDt>

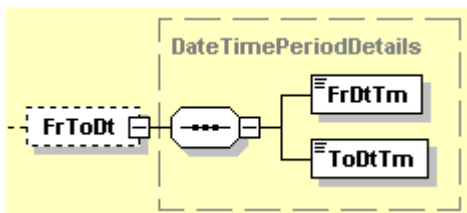

**Presence:** [0..1]

**Definition:** Range of time between the start date and the end date for which the account statement is issued.

**Type:** *This message item is composed of the following DateTimePeriodDetails element(s):*

Ref	Or	Message Item	<XML Tag>	Mult.	Represent./ Type
<a href="#">5.1.0</a>		FromDateTime	<FrDtTm>	[1..1]	DateTime
<a href="#">5.1.1</a>		ToDateTime	<ToDtTm>	[1..1]	DateTime

### 5.1.0 FromDateTime <FrDtTm>



**Presence:** [1..1]

**Definition:** Date and time at which the range starts.

**Data Type:** ISODateTime

### 5.1.1 ToDateTime <ToDtTm>



**Presence:** [1..1]

**Definition:** Date and time at which the range ends.

**Data Type:** ISODateTime

## 2.6 CopyDuplicateIndicator <CpyDplctInd>

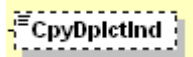

**Presence:** [0..1]

**Definition:** Specifies if this document is a copy, a duplicate, or a duplicate of a copy.

**Data Type:** Code

*When this message item is present, only the following **CopyDuplicate1Code** value must be used:*

**BBA USAGE:** Only code DUPL will be supported

Code	Name	Definition
DUPL	Duplicate	Message is for information/confirmation purposes. It is a duplicate of a message previously sent.



## 2.10 Account <Acct>

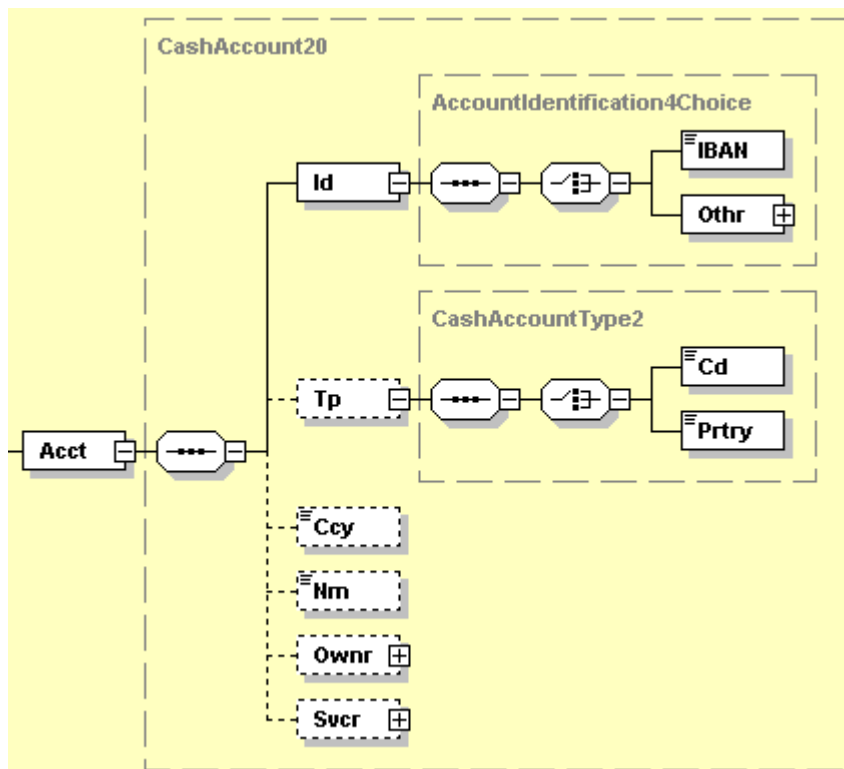

**Presence:** [1..1]

**Definition:** Unambiguous identification of the account to which credit and debit entries are made.

**Type:** *This message item is composed of the following **CashAccount20** element(s):*

Or	Message Item	<XML Tag>	Mult.	Represent./ Type
	Identification	<Id>	[1..1]	
	Type	<Tp>	[0..1]	
	Currency	<Ccy>	[0..1]	Code
	Name	<Nm>	[0..1]	Text
	Owner	<Owncr>	[0..1]	
	Servicer	<Svcr>	[0..1]	

## 1.2.0 Identification <Id>

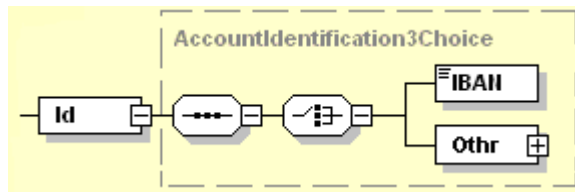

**Presence:** [1..1]

**Definition:** Unique and unambiguous identification of the account between the account owner and the account servicer.

**Type:** *This message item is composed of one of the following **AccountIdentification3Choice** element(s):*

Ref	Or	Message Item	<XML Tag>	Mult.	Represent./ Type
<u>1.2.1</u>	{Or	IBAN	<IBAN>	[1..1]	Identifier
<u>1.2.2</u>	Or}	Other	<Othr>	[1..1]	

### 1.2.1 IBAN <IBAN>

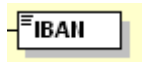

**Presence:** [1..1]

*This message item is part of choice 1.1 AccountIdentification3Choice.*

**Definition:** International Bank Account Number (IBAN) - identifier used internationally by financial institutions to uniquely identify the account of a customer. Further specifications of the format and content of the IBAN can be found in the standard ISO 13616 "Banking and related financial services - International Bank Account Number (IBAN)" version 1997-10-01, or later revisions.

**Data Type:** IBANIdentifier

**Format:** [a-zA-Z]{2,2}[0-9]{2,2}[a-zA-Z0-9]{1,30}

**Rule(s):** IBAN

A valid IBAN consists of all three of the following components: Country Code, check digits and BBAN.

### 1.2.2 Other <Othr>

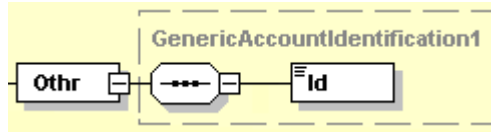

**Presence:** [1..1]

*This message item is part of choice 1.2.0 Identification.*

**Definition:** Unique identification of an account, as assigned by the account servicer, using an identification scheme.

**Type:** *This message item is composed of the following GenericAccountIdentification1 element(s):*

Ref	Or	Message Item	<XML Tag>	Mult.	Represent./ Type
<a href="#">1.2.3</a>		Identification	<Id>	[1..1]	Text

### 1.2.3 Identification <Id>

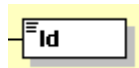

**Presence:** [1..1]

**Definition:** Identification assigned by an institution.

**Data Type:** Max34Text

**Format:** maxLength: 34  
minLength: 1

**BBA USAGE** : account in BBAN format

### 1.2.8 Type <Tp>

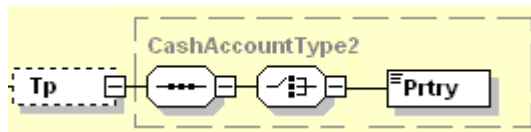

**Presence:** [0..1]

**Definition:** Nature, or use, of the account.

**Type:** *This message item is composed of one of the following CashAccountType2 element(s):*

Ref	Or	Message Item	<XML Tag>	Mult.	Represent./ Type
<a href="#">1.2.10</a>		Proprietary	<Prtry>	[1..1]	Text

### 1.2.10 Proprietary <Prtry>

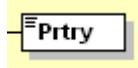

**Presence:** [1..1]

*This message item is part of choice 2.9 Type.*

**Definition:** Proprietary nature or use of the account.

**Data Type:** Max35Text

**Format:** maxLength: 35  
minLength: 1

### 1.2.11 Currency <Ccy>

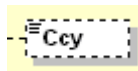

**Presence:** [0..1]

**Definition:** Identification of the currency in which the account is held.

**Data Type:** ActiveOrHistoricCurrencyCode

**Format:** [A-Z]{3,3}

**Rule(s):** ActiveOrHistoricCurrency

The Currency Code must be registered, or have already been registered. Valid active or historic currency codes are registered with the ISO 4217 Maintenance Agency, consist of three (3) contiguous letters, and may be or not be withdrawn on the day the message containing the Currency is exchanged.

(Fatal) Error Code: Sw.Stds.D00006

### 1.2.12 Name <Nm>



**Presence:** [0..1]

**Definition:** Name of the account, as assigned by the account servicing institution, in agreement with the account owner in order to provide an additional means of identification of the account.

**Usage:** The account name is different from the account owner name. The account name is used in certain user communities to provide a means of identifying the account, in addition to the account owner's identity and the account number.

**Data Type:** Max70Text

**Format:** maxLength: 70  
minLength: 1

### 1.2.13 Owner <Ownr>

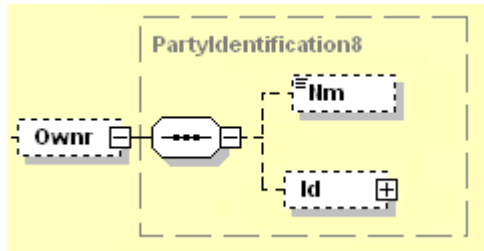

**Presence:** [0..1]

**Definition:** Party that legally owns the account.

**Type:** *This message item is composed of the following PartyIdentification8 element(s):*

Ref	Or	Message Item	<XML Tag>	Mult.	Represent./ Type
<a href="#">1.2.14</a>		Name	<Nm>	[0..1]	Text
<a href="#">1.2.26</a>		Identification	<Id>	[0..1]	

### 1.2.14 Name <Nm>



**Presence:** [0..1]

**Definition:** Name by which a party is known and which is usually used to identify that party.

**Data Type:** Max70Text

**Format:** maxLength: 70  
minLength: 1

### 1.2.26 Identification <Id>

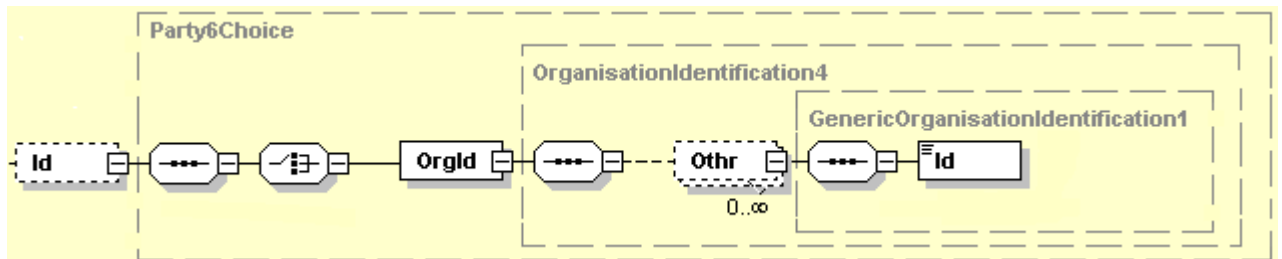

**Presence:** [0..1]

**Definition:** Unique and unambiguous way of identifying an organisation or an individual person.

**Type:** *This message item is composed of one of the following Party6Choice element(s):*

### 1.2.27 OrganisationIdentification <OrgId>



**Presence:** [1..1]

*This message item is part of choice 1.2.26 Identification.*

**Definition:** Unique and unambiguous way to identify an organisation.

**Type:** *This message item is composed of the following OrganisationIdentification4 element(s):*

Ref	Or	Message Item	<XML Tag>	Mult.	Represent./ Type
<a href="#">1.2.29</a>		Other	<Othr>	[0..n]	

### 1.2.29 Other <Othr>

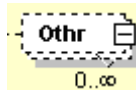

**Presence:** [0..n]

**Definition:** Unique identification of an organisation, as assigned by an institution, using an identification scheme.

**Type:** *This message item is composed of the following GenericOrganisationIdentification1 element(s):*

Ref	Or	Message Item	<XML Tag>	Mult.	Represent./ Type
<a href="#">1.2.30</a>		Identification	<Id>	[1..1]	Text

### 1.2.30 Identification <Id>

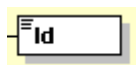

**Presence:** [1..1]

**Definition:** Identification assigned by an institution.

**Data Type:** Max35Text

**Format:** maxLength: 35  
minLength: 1

**BBA USAGE** : Company number

### 1.2.56 Servicer <Svcr>

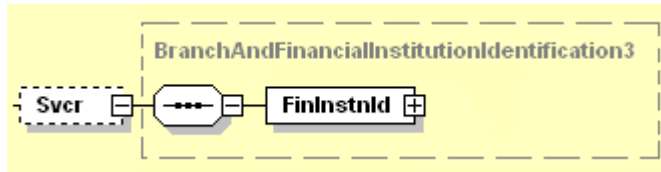

**Presence:** [0..1]

**Definition:** Party that manages the account on behalf of the account owner, that is manages the registration and booking of entries on the account, calculates balances on the account and provides information about the account.

**Type:** *This message item is composed of the following **BranchAndFinancialInstitutionIdentification4** element(s):*

Ref	Or	Message Item	<XML Tag>	Mult.	Represent./ Type
<u>1.2.57</u>		FinancialInstitutionIdentification	<FinInstnId>	[1..1]	

### 1.2.57 FinancialInstitutionIdentification <FinInstnId>

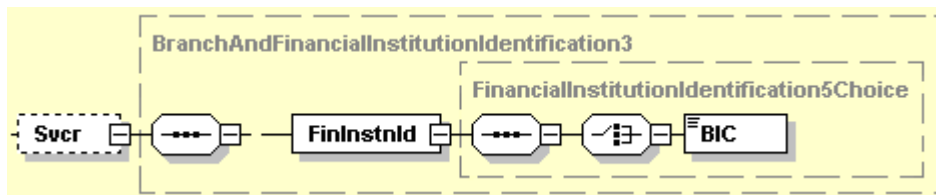

**Presence:** [1..1]

**Definition:** Unique and unambiguous identification of a financial institution, as assigned under an internationally recognised or proprietary identification scheme.

**Type:** *This message item is composed of the following **FinancialInstitutionIdentification7** element(s)*

### 1.2.58 BIC <BIC>

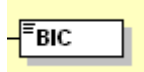

**Presence:** [0..1]

**Definition:** Bank Identifier Code. Code allocated to financial institutions by the Registration Authority, under an international identification scheme, as described in the latest version of the standard ISO 9362 Banking (Banking telecommunication messages, Bank Identifier Codes).

**Data Type:** BICIdentifier

**Format:** [A-Z]{6,6}[A-Z2-9][A-NP-Z0-9]([A-Z0-9]{3,3}){0,1}

**Rule(s):** BIC

Valid BICs are registered with the ISO 9362 Registration Authority, and consist of eight (8) or eleven (11) contiguous characters comprising the first three or all four of the following components: BANK CODE, COUNTRY CODE, LOCATION CODE, BRANCH CODE. The bank code, country code and location code are mandatory, while the branch code is optional.

(Fatal) Error Code: Sw.Stds.D00001

### 2.11 RelatedAccount <RltdAcct>

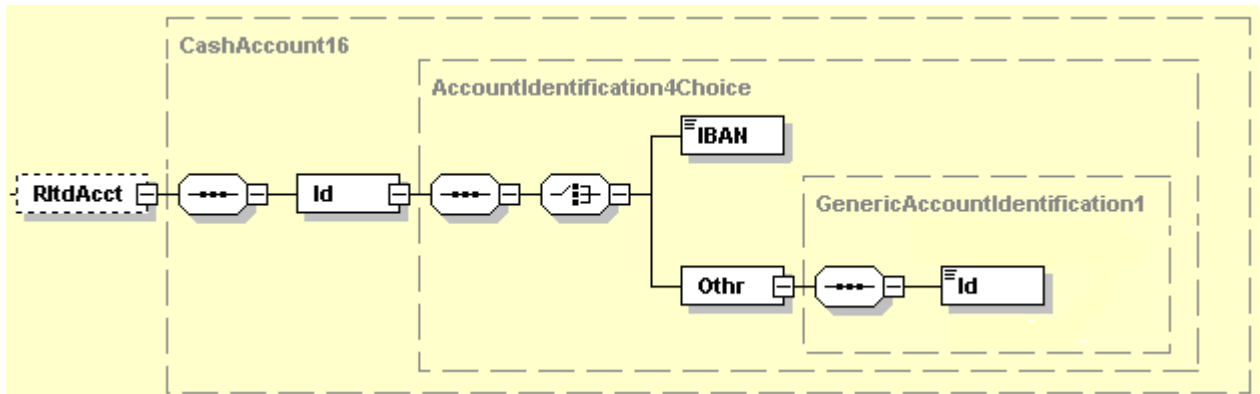

**Presence:** [0..1]

**Definition:** Identifies the parent account of the account for which the statement has been issued.

**Type:** *This message item is composed of the following CashAccount16 element(s):*



### 1.1.0 Identification <Id>



**Presence:** [1..1]

**Definition:** Unique and unambiguous identification for the account between the account owner and the account servicer.

**Type:** *This message item is composed of one of the following **AccountIdentification4Choice** element(s):*

Ref	Or	Message Item	<XML Tag>	Mult.	Represent./ Type
<u>1.1.1</u>	{Or	IBAN	<IBAN>	[1..1]	Identifier
<u>1.1.2</u>	Or}	Other	<Othr>	[1..1]	

#### 1.1.1 IBAN <IBAN>

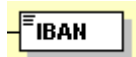

**Presence:** [1..1]

*This message item is part of choice **1.1.0 Identification**.*

**Definition:** International Bank Account Number (IBAN) - identifier used internationally by financial institutions to uniquely identify the account of a customer. Further specifications of the format and content of the IBAN can be found in the standard ISO 13616 "Banking and related financial services - International Bank Account Number (IBAN)" version 1997-10-01, or later revisions.

**Data Type:** IBAN2007Identifier

**Format:** [A-Z]{2,2}[0-9]{2,2}[a-zA-Z0-9]{1,30}

**Rule(s):** IBAN

A valid IBAN consists of all three of the following components: Country Code, check digits and BBAN.

(Fatal) Error Code: Sw.Stds.D00003

### 1.1.2 Other <Othr>

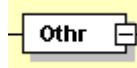

**Presence:** [1..1]

*This message item is part of choice 1.1.0 Identification.*

**Definition:** Unique identification of an account, as assigned by the account servicer, using an identification scheme.

**Type:** *This message item is composed of the following **GenericAccountIdentification1** element(s):*

Ref	Or	Message Item	<XML Tag>	Mult.	Represent./ Type
<u>1.1.3</u>		Identification	<Id>	[1..1]	Text

### 1.1.3 Identification <Id>

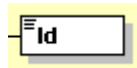

**Presence:** [1..1]

**Definition:** Identification assigned by an institution.

**Data Type:** Max34Text

**Format:** maxLength: 34  
minLength: 1

**BBA USAGE** : account in BBAN format

## 2.23 Balance <Bal>

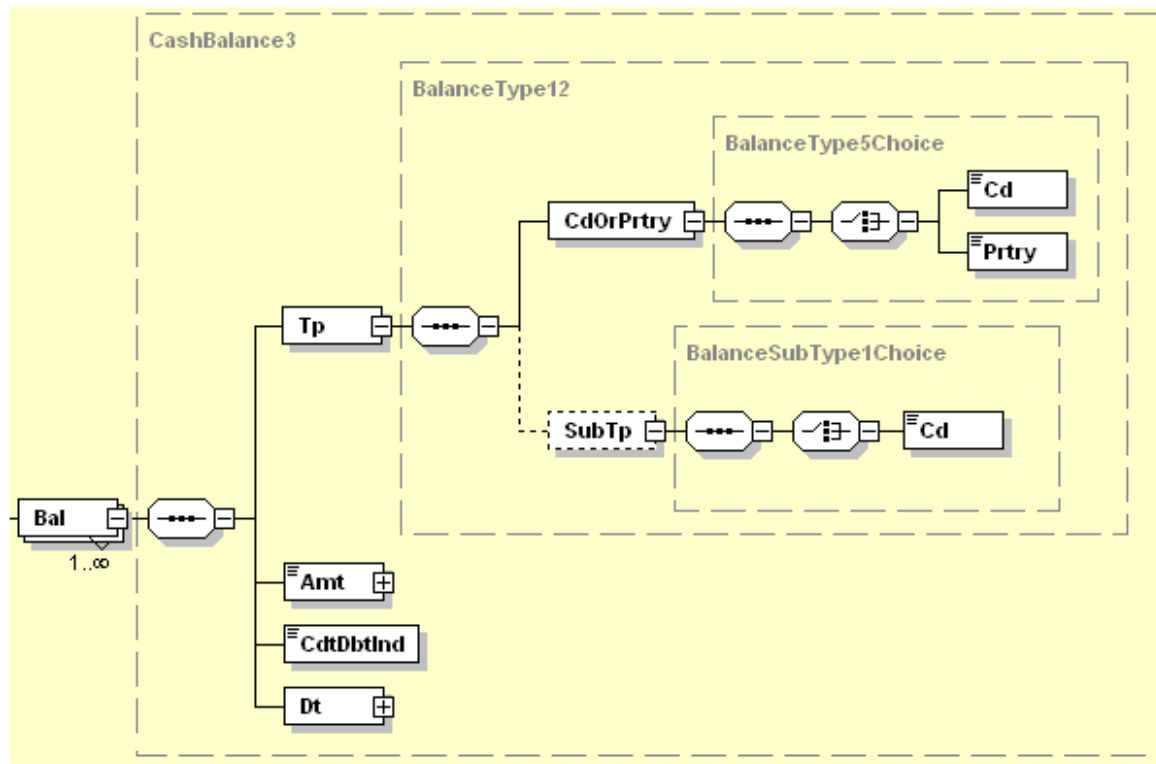

**Presence:** [1..n]

**Definition:** Set of elements defining the balance(s).

**Type:** *This message item is composed of the following **CashBalance3** element(s):*

**Rule(s):** AvailabilityAndTypeRule

Index	Or	Message Item	<XML Tag>	Mult.	Represent./ Type
<a href="#">2.24</a>		Type	<Tp>	[1..1]	
<a href="#">2.34</a>		Amount	<Amt>	[1..1]	Amount
<a href="#">2.35</a>		CreditDebitIndicator	<CdtDbtInd>	[1..1]	Code
<a href="#">2.36</a>		Date	<Dt>	[1..1]	±

## 2.24 Type <Tp>

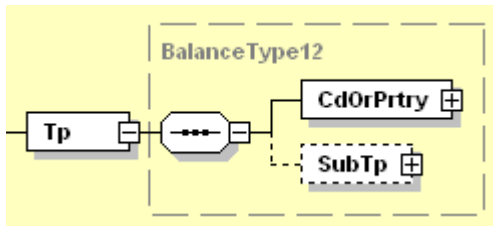

Presence: [1..1]

Definition: Specifies the nature of a balance, eg, opening booked balance.

Type: *This message item is composed of one of the following **BalanceType12Choice** element(s):*

Index	Or	Message Item	<XML Tag>	Mult.	Represent./ Type
<u>2.25</u>		CodeOrProprietary	<CdOrPrtry>	[1..1]	
<u>2.28</u>		SubType	<SubTp>	[0..1]	

## 2.25 CodeOrProprietary <CdOrPrtry>



Presence: [1..1]

Definition: Coded or proprietary format balance type.

Type: *This message item is composed of one of the following **BalanceType5Choice** element(s):*

Index	Or	Message Item	<XML Tag>	Mult.	Represent./ Type
<u>2.26</u>	{Or	Code	<Cd>	[1..1]	Code
<u>2.27</u>	Or}	Proprietary	<Prtry>	[1..1]	Text

## 2.26 Code <Cd>

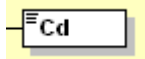

**Presence:** [1..1]

*This message item is part of choice 2.25 CodeOrProprietary.*

**Definition:** Balance type, in a coded form.

**Data Type:** Code

*One of the following BalanceType12Code values must be used*

Code	Name	Definition
CLAV	ClosingAvailable	Closing balance of amount of money that is at the disposal of the account owner on the date specified.
CLBD	ClosingBooked	Balance of the account at the end of the pre-agreed account reporting period. It is the sum of the opening booked balance at the beginning of the period and all entries booked to the account during the pre-agreed account reporting period.
FWAV	ForwardAvailable	Forward available balance of money that is at the disposal of the account owner on the date specified.
INFO	Information	Balance for informational purposes.
OPBD	OpeningBooked	Book balance of the account at the beginning of the account reporting period. It always equals the closing book balance from the previous report.

## 2.27 Proprietary <Prtry>



**Presence:** [1..1]

*This message item is part of choice 2.25 CodeOrProprietary.*

**Definition:** Balance type, in a proprietary form.

**Data Type:** Max35Text

**Format:** maxLength: 35  
minLength: 1

## 2.28 SubType <SubTp>

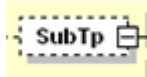

**Presence:** [0..1]

**Definition:** Specifies the balance sub-type.

**Type:** *This message item is composed of one of the following **BalanceSubType1Choice** element(s):*

**BBA USAGE:** Only when a message is split.

Index	Or	Message Item	<XML Tag>	Mult.	Represent./ Type
<u>2.29</u>	{Or	Code	<Cd>	[1..1]	Code
<u>2.30</u>	Or}	Proprietary	<Prtry>	[1..1]	Text

## 2.29 Code <Cd>

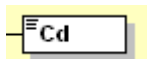

**Presence:** [1..1]

*This message item is part of choice 2.28 SubType.*

**Definition:** Specifies the code for the type of a balance, eg, opening booked balance.

**Data Type:** ExternalBalanceSubType1Code

**Format:** maxLength: 4  
minLength: 1

*Only the following code will be used:*

Code	Name	Definition
INTM	Intermediate Balance	For split/paginated messages, this type code is used together with the OPBD and CLBD balance type codes to indicate the intermediary balances of the split/paginated message.

## 2.34 Amount <Amt>

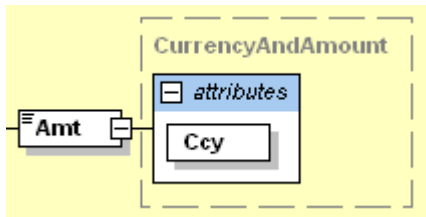

**Presence:** [1..1]

**Definition:** Amount of money of the cash balance.

**Data Type:** ActiveOrHistoricCurrencyAndAmount

*This data type must be used with the following XML Attribute: **Currency (Ccy)** which is typed by **ActiveOrHistoricCurrencyCode**.*

**Format:** **ActiveOrHistoricCurrencyAndAmount**

fractionDigits: 5

minInclusive: 0

totalDigits: 18

**ActiveOrHistoricCurrencyCode**

[A-Z]{3,3}

**Rule(s):** **ActiveOrHistoricCurrencyAndAmount**

CurrencyAmount

The number of fractional digits (or minor unit of currency) must comply with ISO 4217.

Note: The decimal separator is a dot.

(Fatal) Error Code: Sw.Stds.D00007

**ActiveOrHistoricCurrencyCode**

ActiveOrHistoricCurrency

The Currency Code must be registered, or have already been registered. Valid active or historic currency codes are registered with the ISO 4217 Maintenance Agency, consist of three (3) contiguous letters, and may be or not be withdrawn on the day the message containing the Currency is exchanged.

(Fatal) Error Code: Sw.Stds.D00006

## 2.35 CreditDebitIndicator <CdtDbtInd>



**Presence:** [1..1]

**Definition:** Indicates whether the balance is a credit or a debit balance. A zero balance is considered to be a credit balance

**Data Type:** Code

One of the following *CreditDebitCode* values must be used:

Code	Name	Definition
CRDT	Credit	Operation is an increase.
DBIT	Debit	Operation is a decrease.

## 2.36 Date <Dt>

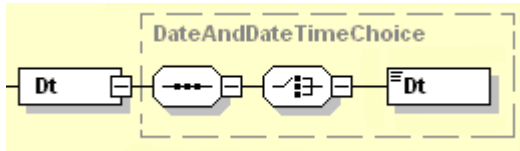

**Presence:** [1..1]

**Definition:** Specifies the date (and time) of the balance.

**Type:** *This message item is composed of one of the following DateAndDateTimeChoice element(s):*

Ref	Or	Message Item	<XML Tag>	Mult.	Represent./ Type
<u>4.1.0</u>		Date	<Dt>	[1..1]	DateTime

### 4.1.0 Date <Dt>

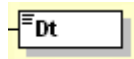

**Presence:** [1..1]

*This message item is part of choice 4.1 DateAndDateTimeChoice.*

**Definition:** Specified date.

**Data Type:** ISODate



## 2.43 TransactionsSummary <TxsSummry>

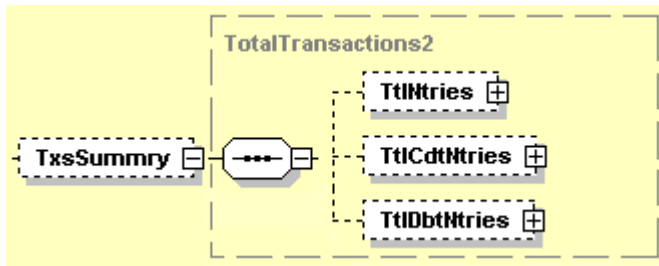

**Presence:** [0..1]

**Definition:** Set of element providing summary information on entries.

**Type:** *This message item is composed of the following TotalTransactions1 element(s):*

**BBA USAGE:** In case of split messages, this is only included in the first partial message, but all transactions of all partial messages are taken into account.

Index	Or	Message Item	<XML Tag>	Mult.	Represent./ Type
<a href="#">2.44</a>		TotalEntries	<TtlNtries>	[0..1]	
<a href="#">2.49</a>		TotalCreditEntries	<TtlCdtNtries>	[0..1]	
<a href="#">2.52</a>		TotalDebitEntries	<TtlDbtNtries>	[0..1]	

## 2.44 TotalEntries <TtlNtries>

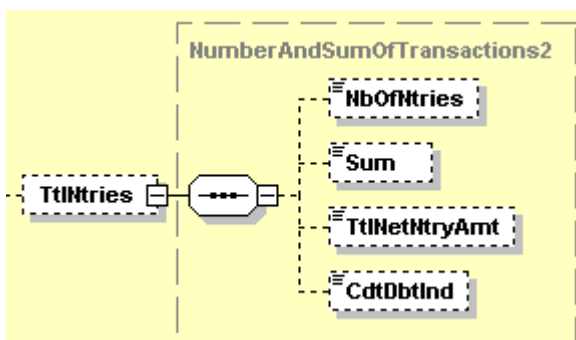

**Presence:** [0..1]

**Definition:** Specifies the total number and sum of debit and credit entries.

**Type:** *This message item is composed of the following NumberAndSumOfTransactions2 element(s):*

Index	Or	Message Item	<XML Tag>	Mult.	Represent./ Type
<a href="#">2.45</a>		NumberOfEntries	<NbOfNtries>	[0..1]	Text
<a href="#">2.46</a>		Sum	<Sum>	[0..1]	Quantity

## 2.45 NumberOfEntries <NbOfNtries>



**Presence:** [0..1]  
**Definition:** Number of individual entries included in the report.  
**Data Type:** Max15NumericText  
**Format:** [0-9]{1,15}

## 2.46 Sum <Sum>

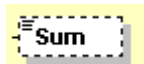

**Presence:** [0..1]  
**Definition:** Total of all individual entries included in the report.  
**Data Type:** DecimalNumber  
**Format:** fractionDigits: 17  
totalDigits: 18

## 2.47 TotalNetEntryAmount <TtINetNtryAmt>

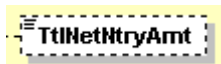

**Presence:** [0..1]  
**Definition:** Resulting amount of the netted amounts for all debit and credit entries.  
**Data Type:** DecimalNumber  
**Format:** fractionDigits: 17  
totalDigits: 18

## 2.48 CreditDebitIndicator <CdtDbtInd>



**Presence:** [0..1]  
**Definition:** Indicates whether the total net entry amount is a credit or a debit amount.  
**Data Type:** Code

*When this message item is present, one of the following **CreditDebitCode** values must be used:*

Code	Name	Definition
CRDT	Credit	Operation is an increase.
DBIT	Debit	Operation is a decrease.

## 2.49 TotalCreditEntries <TtlCdtNtries>

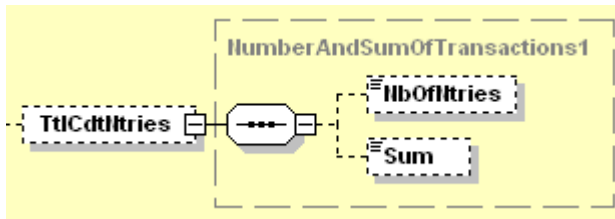

**Presence:** [0..1]

**Definition:** Indicates the total number and sum of credit entries.

**Type:** *This message item is composed of the following NumberAndSumOfTransactions1 element(s):*

Index	Or	Message Item	<XML Tag>	Mult.	Represent./ Type
<a href="#">2.51</a>		NumberOfEntries	<NbOfNtries>	[0..1]	Text
<a href="#">2.52</a>		Sum	<Sum>	[0..1]	Quantity

## 2.50 NumberOfEntries <NbOfNtries>



**Presence:** [0..1]

**Definition:** Number of individual entries included in the report.

**Data Type:** Max15NumericText

**Format:** [0-9]{1,15}

### 2.51 Sum <Sum>

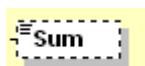

**Presence:** [0..1]

**Definition:** Total of all individual entries included in the report.

**Data Type:** DecimalNumber

**Format:** fractionDigits: 17  
totalDigits: 18

## 2.52 TotalDebitEntries <TtIDbtNtries>

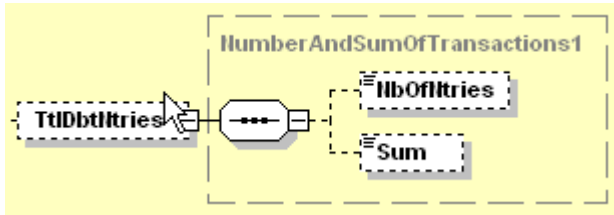

Presence: [0..1]

Definition: Indicates the total number and sum of debit entries.

Type: *This message item is composed of the following **NumberAndSumOfTransactions1** element(s):*

Index	Or	Message Item	<XML Tag>	Mult.	Represent./ Type
2.54		NumberOfEntries	<NbOfNtries>	[0..1]	Text
2.55		Sum	<Sum>	[0..1]	Quantity

## 2.53 NumberOfEntries <NbOfNtries>



Presence: [0..1]

Definition: Number of individual entries included in the report.

Data Type: Max15NumericText

Format: [0-9]{1,15}

## 2.54 Sum <Sum>

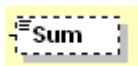

Presence: [0..1]

Definition: Total of all individual entries included in the report.

Data Type: DecimalNumber

Format: fractionDigits: 17  
totalDigits: 18

## 2.76 Entry <Ntry>

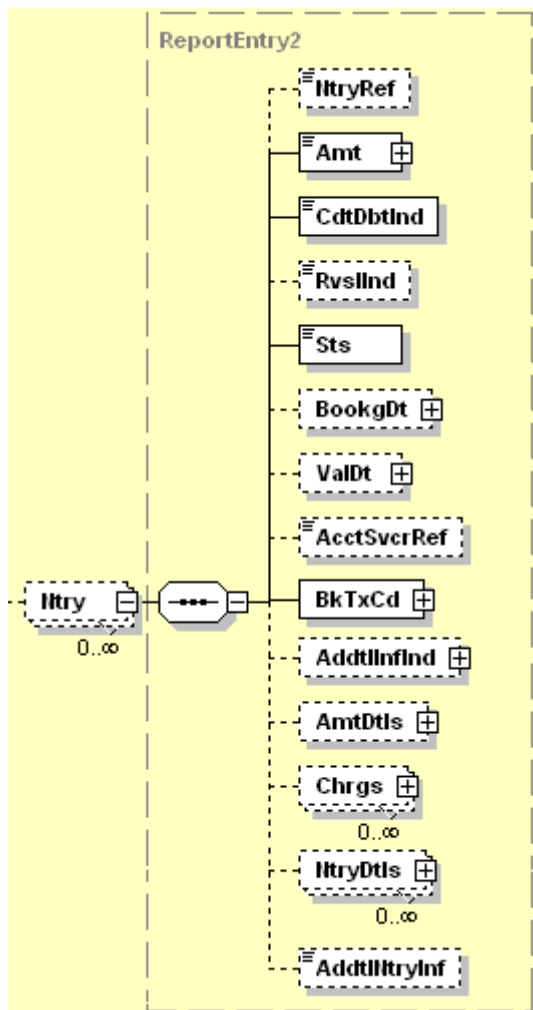

**Presence:** [0..n]

**Definition:** Specifies the elements of an entry in the statement.

**Usage:** At least one reference must be provided to identify the entry and its underlying transaction(s).

**Type:** *This message item is composed of the following **StatementEntry1** element(s):*

Index	Or	Message Item	<XML Tag>	Mult.	Represent./ Type
<a href="#">2.77</a>		EntryReference	<NtryRef>	[0..1]	Text
<a href="#">2.78</a>		Amount	<Amt>	[1..1]	Amount
<a href="#">2.79</a>		CreditDebitIndicator	<CdtDbtInd>	[1..1]	Code
<a href="#">2.80</a>		ReversalIndicator	<RvslInd>	[0..1]	Indicator
<a href="#">2.81</a>		Status	<Sts>	[1..1]	Code
<a href="#">2.82</a>		BookingDate	<BookgDt>	[0..1]	±
<a href="#">2.83</a>		ValueDate	<ValDt>	[0..1]	±
<a href="#">2.84</a>		AccountServicerReference	<AcctSvcrRef>	[0..1]	Text
<a href="#">2.91</a>		BankTransactionCode	<BkTxCd>	[1..1]	
<a href="#">2.101</a>		AdditionalInformationIndicator	<AddtlInfInd>	[0..1]	
<a href="#">2.104</a>		AmountDetails	<AmtDtls>	[0..1]	±
<a href="#">2.105</a>		Charges	<Chrgs>	[0..n]	
<a href="#">2.135</a>		EntryDetails	<NtryDtls>	[0..n]	
<a href="#">2.283</a>		AdditionalEntryInformation	<AddtlNtryInf>	[0..1]	Text

## 2.77 EntryReference <NtryRef>

**Presence:** [0..1]  
**Definition:** Unique reference for the entry.  
**Data Type:** Max35Text  
**Format:** maxLength: 35  
minLength: 1

## 2.78 Amount <Amt>

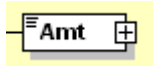

**Presence:** [1..1]

**Definition:** Amount of money in the cash entry.

**Data Type:** ActiveOrHistoricCurrencyAndAmount

*This data type must be used with the following XML Attribute: **Currency (Ccy)** which is typed by **ActiveOrHistoricCurrencyCode**.*

**Format:** ActiveOrHistoricCurrencyAndAmount

fractionDigits: 5

minInclusive: 0

totalDigits: 18

### **ActiveOrHistoricCurrencyCode**

[A-Z]{3,3}

**Rule(s):** **ActiveOrHistoricCurrencyAndAmount**

CurrencyAmount

The number of fractional digits (or minor unit of currency) must comply with ISO 4217.

Note: The decimal separator is a dot.

(Fatal) Error Code: Sw.Stds.D00007

### **ActiveOrHistoricCurrencyCode**

ActiveOrHistoricCurrency

The Currency Code must be registered, or have already been registered. Valid active or historic currency codes are registered with the ISO 4217 Maintenance Agency, consist of three (3) contiguous letters, and may be or not be withdrawn on the day the message containing the Currency is exchanged.

(Fatal) Error Code: Sw.Stds.D00006

## 2.79 CreditDebitIndicator <CdtDbtInd>



**Presence:** [1..1]

**Definition:** Specifies if an entry is a credit or a debit.

**Data Type:** Code

*One of the following **CreditDebitCode** values must be used:*

Code	Name	Definition
CRDT	Credit	Operation is an increase.
DBIT	Debit	Operation is a decrease.

## 2.80 ReversalIndicator <RvslInd>

**Presence:** [0..1]

**Definition:** Indicates whether the entry is the result of a reversal operation.

**Usage:** this element should only be present if the entry is the result of a reversal operation.

If the CreditDebitIndicator is CRDT and ReversalIndicator is Yes, the original operation was a debit entry.

If the CreditDebitIndicator is DBIT and ReversalIndicator is Yes, the original operation was a credit entry.

**Data Type:** *One of the following **TrueFalseIndicator** values must be used:*

MeaningWhenTrue: True

MeaningWhenFalse: False



## 2.81 Status <Sts>

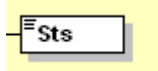

**Presence:** [1..1]

**Definition:** Status of an entry on the books of the account servicer.

**Data Type:** Code

*Only the following **EntryStatus3Code** values must be used:*

Code	Name	Definition
BOOK	Booked	<p>Booked means that the transfer of money has been completed between account servicer and account owner</p> <p>Usage :</p> <p>Status Booked does not necessarily imply finality of money as this depends on other factors such as the payment system used, the completion of the end-to-end transaction and the terms agreed between account servicer and owner.</p> <p>Status Booked is the only status that can be reversed.</p>

## 2.82 BookingDate <BookgDt>

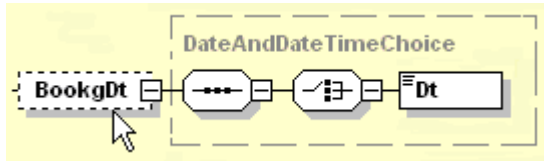

**Presence:** [0..1]

**Definition:** Date and time when an entry is posted to an account on the account servicer's books.

**Type:** *This message item is composed of the following **DateAndDateTimeChoice** element:*

Ref	Or	Message Item	<XML Tag>	Mult.	Represent./ Type
<u>4.1.0</u>		Date	<Dt>	[1..1]	DateTime

#### 4.1.0 Date <Dt>

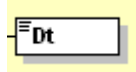

**Presence:** [1..1]

*This message item is part of choice 4.1 DateAndDateTimeChoice.*

**Definition:** Specified date.

**Data Type:** ISODate

### 2.83 ValueDate <ValDt>

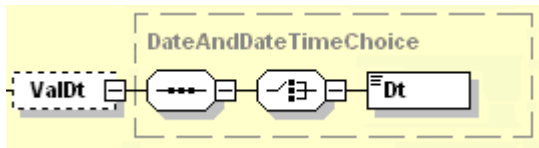

**Presence:** [0..1]

**Definition:** Date and time assets become available to the account owner (in a credit entry), or cease to be available to the account owner (in a debit entry).

**Usage:** For entries which are subject to availability/float (and for which availability information is present), value date must not be used, as the availability component identifies the number of availability days.

**Type:** *This message item is composed of the following DateAndDateTimeChoice element:*

Or	Message Item	<XML Tag>	Mult.	Represent./ Type
	Date	<Dt>	[1..1]	DateTime

#### 4.1.0 Date <Dt>

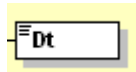

**Presence:** [1..1]

*This message item is part of choice 4.1 DateAndDateTimeChoice.*

**Definition:** Specified date.

**Data Type:** ISODate

## 2.84 AccountServicerReference <AcctSvcrRef>

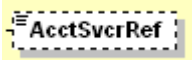

**Presence:** [0..1]

**Definition:** Unique reference as assigned by the account servicing institution to unambiguously identify the entry.

**Data Type:** Max35Text

**Format:** maxLength: 35  
minLength: 1

## 2.91 BankTransactionCode <BkTxCd>

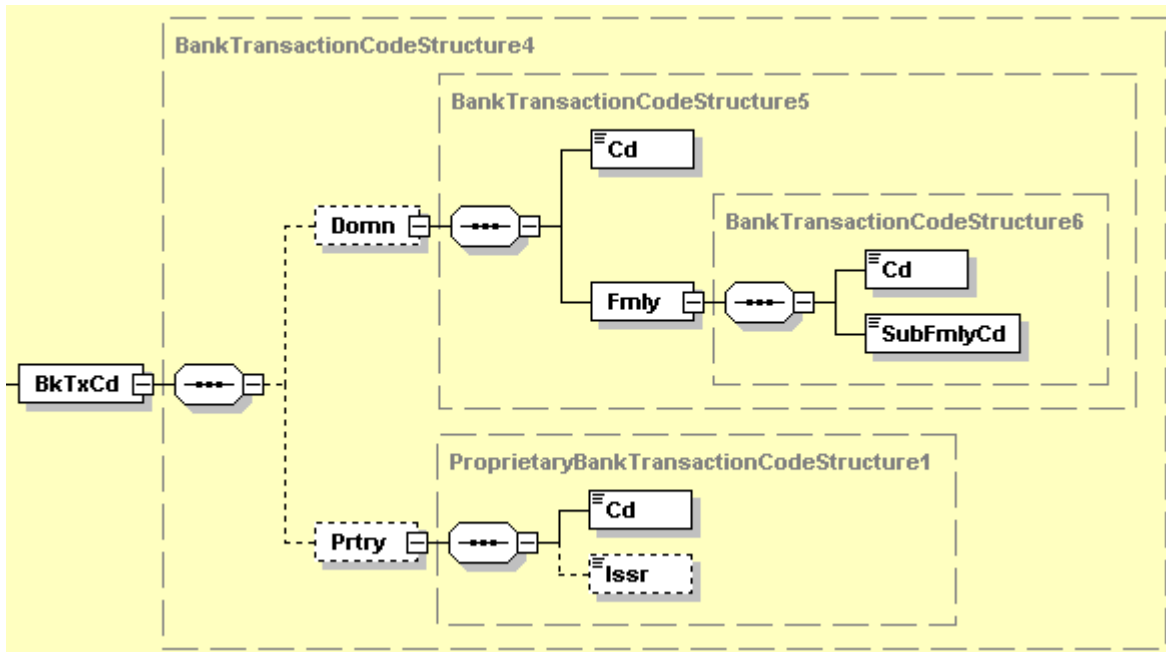

**Presence:** [1..1]

**Definition:** Set of elements to fully identify the type of underlying transaction resulting in an entry.

**Type:** *This message item is composed of the following **BankTransactionCodeStructure1** element(s):*

**Rule(s):** DomainOrProprietaryRule

Either Proprietary or Domain or both must be present.

(Fatal) Error Code: Sw.Stds.X00104

FamilyAndSubFamilyRule

If a specific (non-generic) Family code is not present, then a specific (non-generic) SubFamily code is not allowed.

Index	Or	Message Item	<XML Tag>	Mult.	Represent./ Type
<a href="#">2.92</a>		Domain	<Domn>	[0..1]	
<a href="#">2.97</a>		Proprietary	<Prtry>	[0..1]	

## 2.92 Domain <Domn>



**Presence:** [0..1], R2

**Definition:** Set of elements used to provide the domain, the family and the sub-family of the bank transaction code, in a structured and hierarchical format.

**Usage:** If a specific family or sub-family code cannot be provided, the generic family code defined for the domain or the generic sub-family code defined for the family should be provided.

**Type:** *This message item is composed of the following **BankTransactionCodeStructure5** element(s):*

Index	Or	Message Item	<XML Tag>	Mult.	Represent./ Type
<a href="#">2.93</a>		Code	<Cd>	[1..1]	Code
<a href="#">2.94</a>		Family	<Fmly>	[1..1]	

## 2.93 Code <Cd>

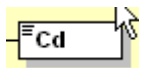

**Presence:** [1..1]

**Definition:** Specifies the business area of the underlying transaction.

**Data Type:** ExternalBankTransactionDomainCode

**Format:** maxLength: 4  
minLength: 1

## 2.94 Family <Fmly>

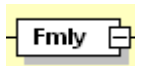

**Presence:** [1..1]

**Definition:** Specifies the family and the sub-family of the bank transaction code, within a specific domain, in a structured and hierarchical format.

**Type:** *This message item is composed of the following **BankTransactionCodeStructure3** element(s):*

Index	Or	Message Item	<XML Tag>	Mult.	Represent./ Type
<a href="#">2.95</a>		Code	<Cd>	[1..1]	Code
<a href="#">2.96</a>		SubFamilyCode	<SubFmlyCd>	[1..1]	Code

## 2.95 Code <Cd>

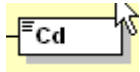

**Presence:** [1..1]  
**Definition:** Specifies the family within a domain.  
**Data Type:** ExternalBankTransactionFamilyCode  
**Format:** maxLength: 4  
 minLength: 1

## 2.96 SubFamilyCode <SubFmlyCd>



**Presence:** [1..1]  
**Definition:** Specifies the sub-product family within a specific family.  
**Data Type:** ExternalBankTransactionSubFamilyCode  
**Format:** maxLength: 4  
 minLength: 1

## 2.97 Proprietary <Prtry>



**Presence:** [0..1]  
**Definition:** Proprietary identification of the bank transaction code, as defined by the issuer.  
**Type:** *This message item is composed of the following **ProprietaryBankTransactionCodeStructure1** element(s):*

Index	Or	Message Item	<XML Tag>	Mult.	Represent./ Type
<u>2.98</u>		Code	<Cd>	[1..1]	Text
<u>2.99</u>		Issuer	<Issr>	[0..1]	Text

## 2.98 Code <Cd>

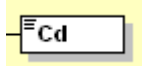

- Presence:** [1..1]  
**Definition:** Proprietary bank transaction code to identify the underlying transaction.  
**Data Type:** Max35Text  
**Format:** maxLength: 35  
 minLength: 1
- BBA USAGE:** For each transaction a BBA Bank Transaction Code will be mentioned (see 5.2)

## 2.99 Issuer <Issr>

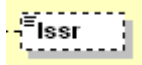

- Presence:** [0..1]  
**Definition:** Identification of the issuer of the proprietary bank transaction code.  
**Data Type:** Max35Text  
**Format:** maxLength: 35  
 minLength: 1
- BBA USAGE:** always the keyword 'BBA'

## 2.101 AdditionalInformationIndicator <AddtlInflnd>

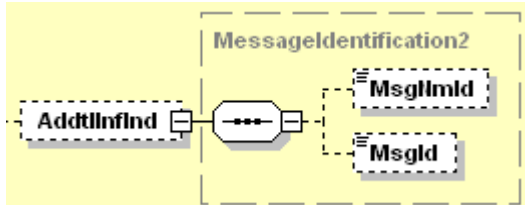

- Presence:** [0..1]  
**Definition:** Indicates whether the underlying transaction details are provided through a separate message, as in the case of aggregate bookings.  
**Type:** *This message item is composed of the following MessageIdentification2 element(s):*

Index	Or	Message Item	<XML Tag>	Mult.	Represent./ Type
2.102		MessageNameIdentification	<MsgNmId>	[0..1]	Text
2.103		MessageIdentification	<MsgId>	[0..1]	Text

## 2.102 MessageNameIdentification <MsgNmId>



<b>Presence:</b>	[0..1]
<b>Definition:</b>	Specifies the message name identifier of the message that will be used to provide additional details.
<b>Data Type:</b>	Max35Text
<b>Format:</b>	maxLength: 35 minLength: 1

## 2.103 MessageIdentification <MsgId>

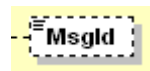

<b>Presence:</b>	[0..1]
<b>Definition:</b>	Specifies the identification of the message that will be used to provide additional details.
<b>Data Type:</b>	Max35Text
<b>Format:</b>	maxLength: 35 minLength: 1



## 2.104 mountDetails <AmtDtls>

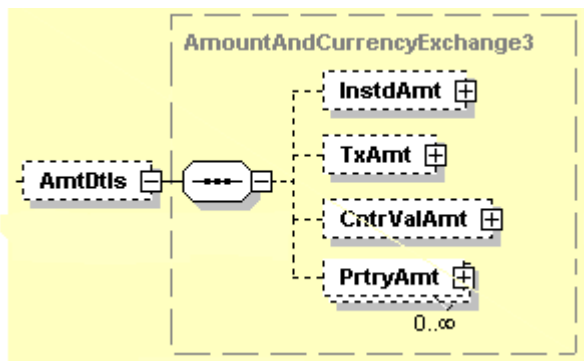

**Presence:** [0..1]

**Definition:** Set of elements providing information on the original amount.

**Usage :** This component (on entry level) should be used when a total original batch or aggregate amount has to be provided. (If required, the original amounts for each individual transaction can be included in the same component on transaction details level.)

**Type:** *This message item is composed of the following AmountAndCurrencyExchange3 element(s):*

**BBA USAGE:** see 4.6 - Reporting of different kinds of amounts

Ref	Or	Message Item	<XML Tag>	Mult.	Represent./ Type
<a href="#">2.1.0</a>		InstructedAmount	<InstdAmt>	[0..1]	
<a href="#">2.1.9</a>		TransactionAmount	<TxAmt>	[0..1]	
<a href="#">2.1.18</a>		CounterValueAmount	<CntrValAmt>	[0..1]	
<a href="#">2.1.36</a>		ProprietaryAmount	<PrtryAmt>	[0..n]	

## 2.1.0 InstructedAmount <InstdAmt>

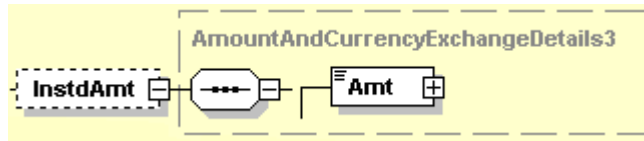

**Presence:** [0..1]

**Definition:** Identifies the amount of money to be moved between the debtor and creditor, before deduction of charges, expressed in the currency as ordered by the initiating party and provides currency exchange info in case the instructed amount and/or currency is/are different from the entry amount and/or currency.

**Type:** *This message item is composed of the following AmountAndCurrencyExchangeDetails3 element(s):*

Ref	Or	Message Item	<XML Tag>	Mult.	Represent./ Type
<u>2.1.0</u>		InstructedAmount	<InstdAmt>	[0..1]	
<u>2.1.1</u>		Amount	<Amt>	[1..1]	Amount

## 2.1.1 Amount <Amt>

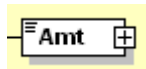

**Presence:** [1..1]

**Definition:** Amount of money to be moved between the debtor and creditor, before deduction of charges, expressed in the currency as ordered by the initiating party.

**Data Type:** CurrencyAndAmount

*This data type must be used with the following XML Attribute: Currency (Ccy) which is typed by CurrencyCode.*

**Format:** **CurrencyAndAmount**

fractionDigits: 5

minInclusive: 0

totalDigits: 18

**CurrencyCode**

[A-Z]{3,3}

**Rule(s):** **CurrencyCode**

ValidationByTable

## 2.1.9 TransactionAmount <TxAmt>

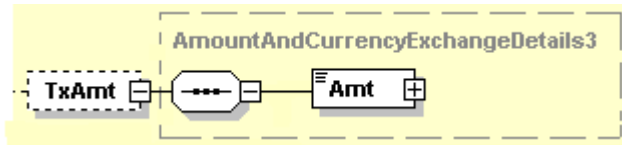

**Presence:** [0..1]

**Definition:** Amount of the underlying transaction.

**Type:** *This message item is composed of the following AmountAndCurrencyExchangeDetails3 element(s):*

## 2.1.10 Amount <Amt>

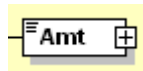

**Presence:** [1..1]

**Definition:** Amount of money to be moved between the debtor and creditor, before deduction of charges, expressed in the currency as ordered by the initiating party.

**Data Type:** ActiveOrHistoricCurrencyAndAmount

*This data type must be used with the following XML Attribute: **Currency (Ccy)** which is typed by*

*ActiveOrHistoricCurrencyCode.*

**Format:** ActiveOrHistoricCurrencyAndAmount

fractionDigits: 5

minInclusive: 0

totalDigits: 18

**ActiveOrHistoricCurrencyCode**

[A-Z]{3,3}

**Rule(s):** ActiveOrHistoricCurrencyAndAmount

CurrencyAmount

### 2.1.18 CounterValueAmount <CntrValAmt>

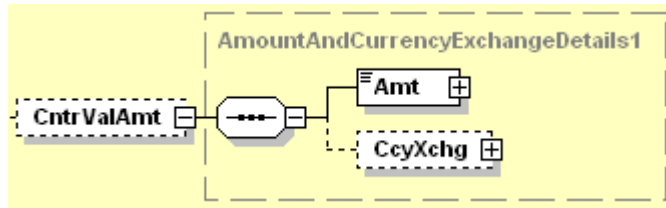

**Presence:** [0..1]

**Definition:** Set of elements used to provide the countervalue amount and currency exchange information.

**Usage:** This can be either the counter amount quoted in an FX deal, or the result of the currency information applied to an instructed amount, before deduction of charges.

**Type:** *This message item is composed of the following AmountAndCurrencyExchangeDetails3 element(s):*

### 2.1.19 Amount <Amt>

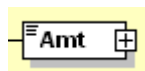

**Presence:** [1..1]

**Definition:** Amount of money to be moved between the debtor and creditor, before deduction of charges, expressed in the currency as ordered by the initiating party.

**Data Type:** CurrencyAndAmount

*This data type must be used with the following XML Attribute: Currency (Ccy) which is typed by CurrencyCode.*

**Format:** **CurrencyAndAmount**

fractionDigits: 5

minInclusive 0

totalDigits: 18

**CurrencyCode**

[A-Z]{3,3}

**Rule(s):** **CurrencyCode**

ValidationByTable

## 2.1.20 CurrencyExchange <CcyXchg>

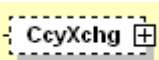

**Presence:** [0..1]

**Definition:** Reports on currency exchange information.

**Type:** *This message item is composed of the following CurrencyExchange3 element(s):*

<a href="#">2.1.21</a>	SourceCurrency	<SrcCcy>	[1..1]	Code
<a href="#">2.1.22</a>	TargetCurrency	<TrgtCcy>	[0..1]	Code
<a href="#">2.1.23</a>	UnitCurrency	<UnitCcy>	[0..1]	Code
<a href="#">2.1.24</a>	ExchangeRate	<XchgRate>	[1..1]	Rate

## 2.1.21 SourceCurrency <SrcCcy>

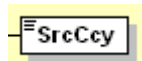

**Presence:** [1..1]

UNIFI (ISO 20022) - Bank-to-Customer Cash Management Standards April 2007  
Message Item Types  
Page 343

**Definition:** Currency of the amount to be converted in a currency conversion.

**Data Type:** CurrencyCode

**Format:** [A-Z]{3,3}

**Rule(s):** ValidationByTable

## 2.1.22 TargetCurrency <TrgtCcy>

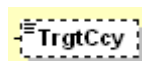

**Presence:** [0..1]

**Definition:** Currency into which an amount is to be converted in a currency conversion.

**Data Type:** CurrencyCode

**Format:** [A-Z]{3,3}

**Rule(s):** ValidationByTable

### 2.1.23 UnitCurrency <UnitCcy>

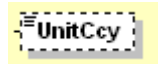

**Presence:** [0..1]  
**Definition:** Currency in which the rate of exchange is expressed in a currency exchange. In the example 1GBP = xxxCUR, the unit currency is GBP.  
**Data Type:** CurrencyCode  
**Format:** [A-Z]{3,3}  
**Rule(s):** ValidationByTable

### 2.1.24 ExchangeRate <XchgRate>



**Synonym(s):** :92A::EXCH (ISO 15022)  
**Presence:** [1..1]  
**Definition:** Factor used for the conversion of an amount from one currency into another. This reflects the price at which one currency was bought with another currency.  
**Usage:** ExchangeRate expresses the ratio between UnitCurrency and QuotedCurrency (ExchangeRate = UnitCurrency/QuotedCurrency).  
**Data Type:** BaseOneRate  
**Format:** fractionDigits: 10  
totalDigits: 11

### 2.1.36 ProprietaryAmount <PrtryAmt>

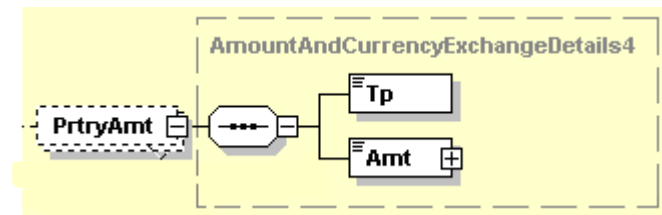

**Presence:** [0..n]  
**Definition:** Set of elements used to provide information on the original amount and currency exchange.  
**Type:** *This message item is composed of the following AmountAndCurrencyExchangeDetails4 element(s):*

Ref	Or	Message Item	<XML Tag>	Mult.	Represent./ Type
<a href="#">2.1.37</a>		Type	<Tp>	[1..1]	Text
<a href="#">2.1.38</a>		Amount	<Amt>	[1..1]	Amount

### 2.1.37 Type <Tp>

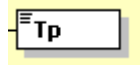

<b>Presence:</b>	[1..1]
<b>Definition:</b>	Specifies the type of amount.
<b>Data Type:</b>	Max35Text
<b>Format:</b>	maxLength: 35 minLength: 1

### 2.1.38 Amount <Amt>



<b>Presence:</b>	[1..1]
<b>Definition:</b>	Amount of money to be exchanged against another amount of money in the counter currency.
<b>Data Type:</b>	ActiveOrHistoricCurrencyAndAmount <i>This data type must be used with the following XML Attribute: <b>Currency (Ccy)</b> which is typed by <b>ActiveOrHistoricCurrencyCode</b>.</i>
<b>Format:</b>	ActiveOrHistoricCurrencyAndAmount

fractionDigits: 5  
minInclusive: 0  
totalDigits: 18

#### **ActiveOrHistoricCurrencyCode**

[A-Z]{3,3}

**Rule(s):** **ActiveOrHistoricCurrencyAndAmount**

CurrencyAmount

The number of fractional digits (or minor unit of currency) must comply with ISO 4217.

Note: The decimal separator is a dot.

(Fatal) Error Code: Sw.Stds.D00007

#### **ActiveOrHistoricCurrencyCode**

ActiveOrHistoricCurrency

The Currency Code must be registered, or have already been registered. Valid active or historic currency codes are registered with the ISO 4217 Maintenance Agency, consist of three (3) contiguous letters, and may be or not be withdrawn on the day the message containing the Currency is exchanged.

(Fatal) Error Code: Sw.Stds.D00006

## 2.105 Charges <Chrgs>

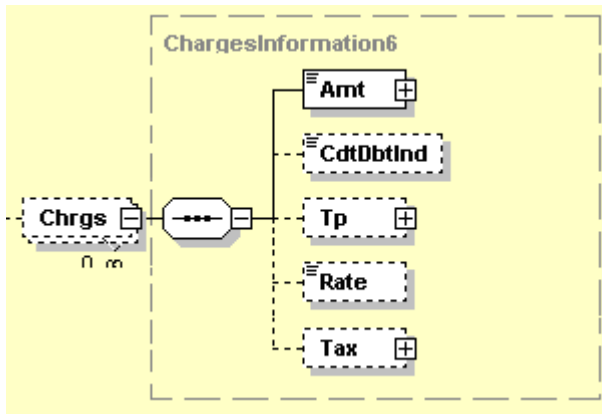

**Presence:** [0..n]

**Definition:** Provides information on the charges included in the entry amount.

**Usage:** This component is used on entry level in case of batch or aggregate bookings.

**Type:** *This message item is composed of the following **ChargesInformation6** element(s):*

**BBA USAGE :** see 4.1.1 - Information registered under the 'Entry' item

Index	Or	Message Item	<XML Tag>	Mult.	Represent./ Type
<a href="#">2.107</a>		Amount	<Amt>	[1..1]	Amount
<a href="#">2.108</a>		CreditDebitIndicator	<CdtDbtInd>	[0..1]	Code
<a href="#">2.109</a>		Type	<Tp>	[0..1]	
<a href="#">2.112</a>		Rate	<Rate>	[0..1]	Rate
<a href="#">2.115</a>		Tax	<Tax>	[0..1]	



## 2.107 Amount <Amt>

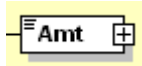

**Presence:** [1..1]

**Definition:** Transaction charges to be paid by the charge bearer.

**Data Type:** ActiveOrHistoricCurrencyAndAmount

*This data type must be used with the following XML Attribute: **Currency (Ccy)** which is typed by **ActiveOrHistoricCurrencyCode**.*

**Format:** **ActiveOrHistoricCurrencyAndAmount**

fractionDigits: 5

minInclusive: 0

totalDigits: 18

**ActiveOrHistoricCurrencyCode**

[A-Z]{3,3}

**Rule(s):** **ActiveOrHistoricCurrencyAndAmount**

CurrencyAmount

The number of fractional digits (or minor unit of currency) must comply with ISO 4217.

Note: The decimal separator is a dot.

(Fatal) Error Code: Sw.Stds.D00007

**ActiveOrHistoricCurrencyCode**

ActiveOrHistoricCurrency

The Currency Code must be registered, or have already been registered. Valid active or historic currency codes are registered with the ISO 4217 Maintenance Agency, consist of three (3) contiguous letters, and may be or not be withdrawn on the day the message containing the Currency is exchanged.

(Fatal) Error Code: Sw.Stds.D00006

## 2.108 CreditDebitIndicator <CdtDbtInd>



**Presence:** [0..1]

**Definition:** Indicates whether the charges amount is a credit or a debit amount.

**Usage:** A zero amount is considered to be a credit.

**Data Type:** Code

When this message item is present, one of the following *CreditDebitCode* values must be used:

Code	Name	Definition
CRDT	Credit	Operation is an increase.
DBIT	Debit	Operation is a decrease.

## 2.109 Type <Tp>

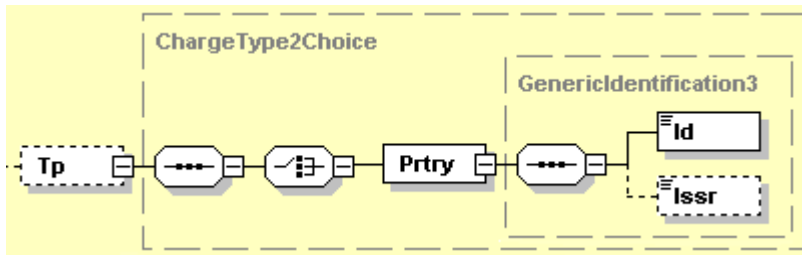

**Presence:** [0..1]

**Definition:** Specifies the type of charge.

**Type:** This message item is composed of the following *ChargeType2Choice* element:

Index	Or	Message Item	<XML Tag>	Mult.	Represent./ Type
<u>2.111</u>		Proprietary	<Prtry>	[1..1]	±

## 2.111 Proprietary <Prtry>

**Presence:** [1..1]

This message item is part of choice 2.176 Type.

**Definition:** Type of charge in a proprietary form, as defined by the issuer.

**Type:** This message item is composed of the following *GenericIdentification3* element(s):

Ref	Or	Message Item	<XML Tag>	Mult.	Represent./ Type
<u>7.1.0</u>		Identification	<Id>	[1..1]	Text
<u>7.1.1</u>		Issuer	<Issr>	[0..1]	Text

### 7.1.0 Identification <Id>

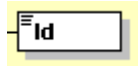

**Presence:** [1..1]

**Definition:** Name or number assigned by an entity to enable recognition of that entity, eg, account identifier.

**Data Type:** Max35Text

**Format:** maxLength: 35  
minLength: 1

**BBA USAGE:** Use the codes that are mentioned for the different categories – cf. annex 6.2 - Category.

### 7.1.1 Issuer <Issr>

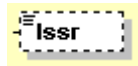

**Presence:** [0..1]

**Definition:** Entity that assigns the identification.

**Data Type:** Max35Text

**Format:** maxLength: 35  
minLength: 1

## 2.112 Rate <Rate>



**Presence:** [0..1]

**Definition:** Rate used to calculate the amount of the charge or fee.

**Data Type:** PercentageRate

**Format:** fractionDigits: 10  
totalDigits: 11

## 2.115 Tax <Tax>

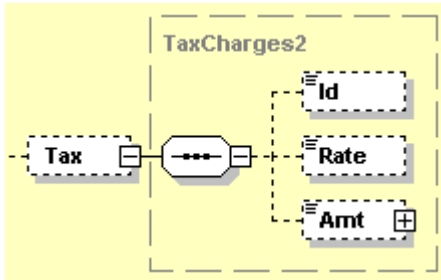

Index	Or	Message Item	<XML Tag>	Mult.	Represent./ Type
<a href="#">2.116</a>		Identification	<Id>	[0..1]	Text
<a href="#">2.117</a>		Rate	<Rate>	[0..1]	Rate
<a href="#">2.118</a>		Amount	<Amt>	[0..1]	Amount

**Presence:** [0..1]

**Definition:** Set of elements used to provide details on the tax applied to charges.

**Type:** *This message item is composed of the following **TaxCharges2** element(s):*

## 2.116 Identification <Id>

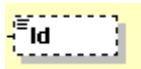

**Presence:** [0..1]

**Definition:** Unique reference to unambiguously identify the nature of the tax levied, such as Value Added Tax (VAT)

**Data Type:** Max35Text

**Format:** maxLength: 35  
minLength: 1

## 2.117 Rate <Rate>



**Presence:** [0..1]

**Definition:** Rate used to calculate the tax.

**Data Type:** PercentageRate

**Format:** fractionDigits: 10  
totalDigits: 11

## 2.118 Amount <Amt>

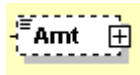

**Presence:** [0..1]

**Definition:** Amount of money resulting from the calculation of the tax.

**Data Type:** ActiveOrHistoricCurrencyAndAmount

*This data type must be used with the following XML Attribute: **Currency (Ccy)** which is typed by **ActiveOrHistoricCurrencyCode**.*

**Format:** ActiveOrHistoricCurrencyAndAmount

fractionDigits: 5

minInclusive: 0

totalDigits: 18

### **ActiveOrHistoricCurrencyCode**

[A-Z]{3,3}

**Rule(s):** **ActiveOrHistoricCurrencyAndAmount**

CurrencyAmount

The number of fractional digits (or minor unit of currency) must comply with ISO 4217.

Note: The decimal separator is a dot.

(Fatal) Error Code: Sw.Stds.D00007

### **ActiveOrHistoricCurrencyCode**

ActiveOrHistoricCurrency

The Currency Code must be registered, or have already been registered. Valid active or historic currency codes are registered with the ISO 4217 Maintenance Agency, consist of three (3) contiguous letters, and may be or not be withdrawn on the day the message containing the Currency is exchanged.

(Fatal) Error Code: Sw.Stds.D00006

## 2.135 EntryDetails <NtryDtls>

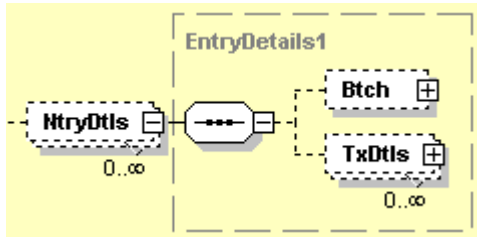

**Presence:** [0..n]

**Definition:** Set of elements used to provide details on the entry.

**Type:** *This message item is composed of the following **EntryDetails1** element(s):*

Index	Or	Message Item	<XML Tag>	Mult.	Represent./ Type
<a href="#">2.136</a>		Batch	<Btch>	[0..1]	
<a href="#">2.142</a>		TransactionDetails	<TxDtls>	[0..n]	

## 2.136 Batch <Btch>

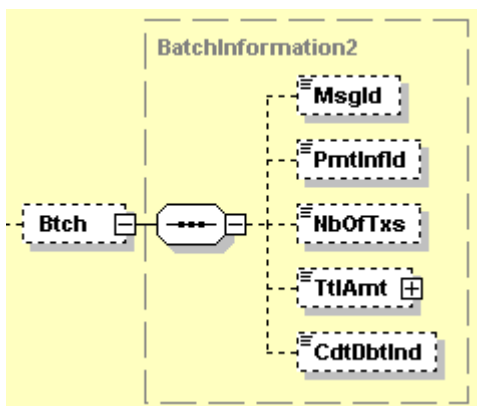

**Presence:** [0..1]

**Definition:** Set of elements used to provide details on batched transactions.

**Type:** *This message item is composed of the following **BatchInformation2** element(s):*

**BBA USAGE:** This item will be used only in case of reporting related to globalised transactions booked on the account either by the client or by the bank.

Index	Or	Message Item	<XML Tag>	Mult.	Represent./ Type
<a href="#">2.137</a>		MessageIdentification	<MsgId>	[0..1]	Text
<a href="#">2.138</a>		PaymentInformationIdentification	<PmtInflId>	[0..1]	Text
<a href="#">2.139</a>		NumberOfTransactions	<NbOfTxs>	[0..1]	Text
<a href="#">2.140</a>		TotalAmount	<TtlAmt>	[0..1]	Amount
<a href="#">2.141</a>		CreditDebitIndicator	<CdtDbtInd>	[0..1]	Code

## 2.137 MessageIdentification <Msgld>



<b>Presence:</b>	[0..1]
<b>Definition:</b>	Point to point reference, as assigned by the sending party, to unambiguously identify the batch of transactions.
<b>Data Type:</b>	Max35Text
<b>Format:</b>	maxLength: 35 minLength: 1

## 2.138 PaymentInformationIdentification <PmtInfd>



<b>Presence:</b>	[0..1]
<b>Definition:</b>	Unique identification, as assigned by a sending party, to unambiguously identify the payment information group within the message.
<b>Data Type:</b>	Max35Text
<b>Format:</b>	maxLength: 35 minLength: 1

## 2.139 NumberOfTransactions <NbOfTxs>

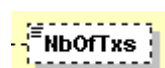

<b>Presence:</b>	[0..1]
<b>Definition:</b>	Number of individual transactions included in the batch.
<b>Data Type:</b>	Max15NumericText
<b>Format:</b>	[0-9]{1,15}

## 2.140 TotalAmount <TtlAmt>



**Presence:** [0..1]

**Definition:** Total amount of money reported in the batch entry.

**Data Type:** ActiveOrHistoricCurrencyAndAmount

*This data type must be used with the following XML Attribute: **Currency (Ccy)** which is typed by **ActiveOrHistoricCurrencyCode**.*

**Format:** **ActiveOrHistoricCurrencyAndAmount**

fractionDigits: 5

minInclusive: 0

totalDigits: 18

**ActiveOrHistoricCurrencyCode**

[A-Z]{3,3}

**Rule(s):** **ActiveOrHistoricCurrencyAndAmount**

CurrencyAmount

The number of fractional digits (or minor unit of currency) must comply with ISO 4217.

Note: The decimal separator is a dot.

(Fatal) Error Code: Sw.Stds.D00007

**ActiveOrHistoricCurrencyCode**

ActiveOrHistoricCurrency

The Currency Code must be registered, or have already been registered. Valid active or historic currency codes are registered with the ISO 4217 Maintenance Agency, consist of three (3) contiguous letters, and may be or not be withdrawn on the day the message containing the Currency is exchanged.

(Fatal) Error Code: Sw.Stds.D00006

## 2.141 CreditDebitIndicator <CdtDbtInd>



**Presence:** [0..1]

**Definition:** Indicates whether the batch entry is a credit or a debit entry.

**Data Type:** Code

*When this message item is present, one of the following **CreditDebitCode** values must be used:*

Code	Name	Definition
CRDT	Credit	Operation is an increase.
DBIT	Debit	Operation is a decrease.



## 2.142 TransactionDetails <TxDtls>

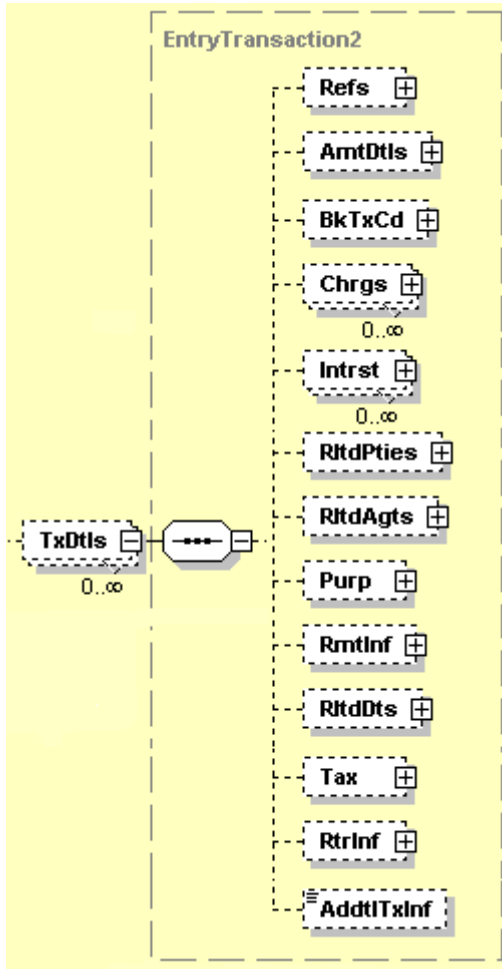

**Presence:** [0..n]

**Definition:** Set of elements providing information on the underlying transaction (s).

**Type:** *This message item is composed of the following **EntryTransaction2** element(s):*

Index	Or	Message Item	<XML Tag>	Mult.	Represent./ Type
<a href="#">2.143</a>		References	<Refs>	[0..1]	
<a href="#">2.156</a>		AmountDetails	<AmtDtls>	[0..1]	±
<a href="#">2.163</a>		BankTransactionCode	<BkTxCd>	[0..1]	
<a href="#">2.172</a>		Charges	<Chrgs>	[0..n]	
<a href="#">2.186</a>		Interest	<Intrst>	[0..n]	
<a href="#">2.199</a>		RelatedParties	<RltdPties>	[0..1]	
<a href="#">2.211</a>		RelatedAgents	<RltdAgts>	[0..1]	
<a href="#">2.224</a>		Purpose	<Purp>	[0..1]	
<a href="#">2.234</a>		RemittanceInformation	<RmtInf>	[0..1]	±
<a href="#">2.235</a>		RelatedDates	<RltdDts>	[0..1]	
<a href="#">2.261</a>		Tax	<Tax>	[0..1]	±
<a href="#">2.262</a>		ReturnInformation	<RtrInf>	[0..1]	
<a href="#">2.282</a>		AdditionalTransactionInformation	<AddtlTxInf>	[0..1]	Text

## 2.143 References <Refs>

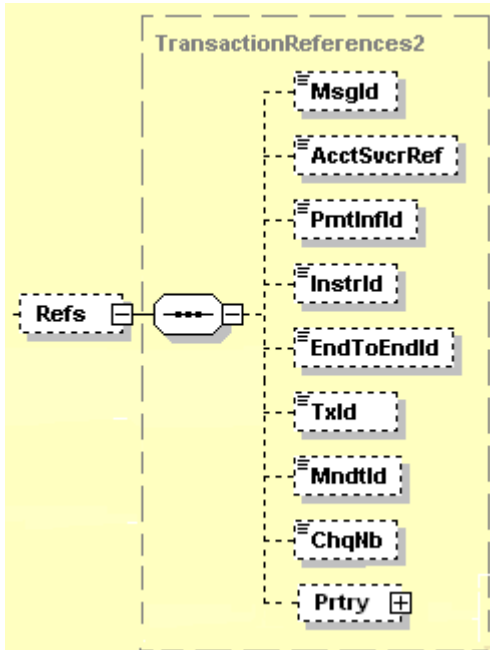

**Presence:** [0..1]

**Definition:** Set of elements used to provide the identification of the underlying transaction.

**Type:** *This message item is composed of the following TransactionReferences2 element(s):*

**BBA USAGE:** see 4.5 - Reporting of the SEPA customer references

Index	Or	Message Item	<XML Tag>	Mult.	Represent./ Type
<a href="#">2.144</a>		MessageIdentification	<MsgId>	[0..1]	Text
<a href="#">2.145</a>		AccountServicerReference	<AcctSvcrRef>	[0..1]	Text
<a href="#">2.146</a>		PaymentInformationIdentification	<PmtInflId>	[0..1]	Text
<a href="#">2.147</a>		InstructionIdentification	<InstrId>	[0..1]	Text
<a href="#">2.148</a>		EndToEndIdentification	<EndToEndId>	[0..1]	Text
<a href="#">2.149</a>		TransactionIdentification	<TxId>	[0..1]	Text
<a href="#">2.150</a>		MandateIdentification	<MndtId>	[0..1]	Text
<a href="#">2.151</a>		ChequeNumber	<ChqNb>	[0..1]	Text
<a href="#">2.153</a>		Proprietary	<Prtry>	[0..1]	

## 2.144 MessageIdentification <MsgId>

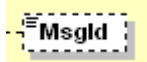

<b>Presence:</b>	[0..1]
<b>Definition:</b>	Point to point reference assigned by the instructing party of the underlying message.
<b>Data Type:</b>	Max35Text
<b>Format:</b>	maxLength: 35 minLength: 1

## 2.145 AccountServicerReference <AcctSvcrRef>

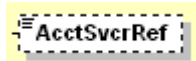

<b>Presence:</b>	[0..1]
<b>Definition:</b>	The account servicing institution's reference for the transaction.
<b>Data Type:</b>	Max35Text
<b>Format:</b>	maxLength: 35 minLength: 1

## 2.146 PaymentInformationIdentification <PmtInflId>



<b>Presence:</b>	[0..1]
<b>Definition:</b>	Unique identification, as assigned by a sending party, to unambiguously identify the payment information group within the message.
<b>Data Type:</b>	Max35Text
<b>Format:</b>	maxLength: 35 minLength: 1

## 2.147 InstructionIdentification <InstrId>



<b>Presence:</b>	[0..1]
<b>Definition:</b>	Unique identification as assigned by an instructing party for an instructed party to unambiguously identify the instruction.
<b>Usage:</b>	the instruction identification is a point to point reference that can be used between the instructing party and the instructed party to refer to the individual instruction. It can be included in several messages related to the instruction.
<b>Data Type:</b>	Max35Text
<b>Format:</b>	maxLength: 35 minLength: 1

## 2.148 EndToEndIdentification <EndToEndId>

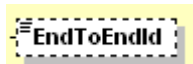

<b>Presence:</b>	[0..1]
<b>Definition:</b>	Unique identification, as assigned by the initiating party, to unambiguously identify the transaction. This identification is passed on, unchanged, throughout the entire end-to-end chain.
<b>Usage:</b>	The end-to-end identification can be used for reconciliation or to link tasks relating to the transaction. It can be included in several messages related to the transaction.
<b>Usage:</b>	In case there are technical limitations to pass on multiple references, the end-to-end identification must be passed on throughout the entire end-to-end chain.
<b>Data Type:</b>	Max35Text
<b>Format:</b>	maxLength: 35 minLength: 1

## 2.149 TransactionIdentification <TxId>

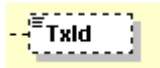

**Presence:** [0..1]

**Definition:** Unique identification, as assigned by the first instructing agent, to unambiguously identify the transaction that is passed on, unchanged, throughout the entire interbank chain.

**Usage:** The transaction identification can be used for reconciliation, tracking or to link tasks relating to the transaction on the interbank level.

**Usage:** The instructing agent has to make sure that the transaction identification is unique for a pre-agreed period.

**Data Type:** Max35Text

**Format:** maxLength: 35  
minLength: 1

## 2.150 MandateIdentification <MndtId>



**Presence:** [0..1]

**Definition:** Reference of the direct debit mandate that has been signed between by the debtor and the creditor.

**Data Type:** Max35Text

**Format:** maxLength: 35  
minLength: 1

## 2.151 ChequeNumber <ChqNb>



**Presence:** [0..1]

**Definition:** Unique and unambiguous identifier for a cheque as assigned by the agent.

**Data Type:** Max35Text

**Format:** maxLength: 35  
minLength: 1

## 2.153 Proprietary <Prtry>

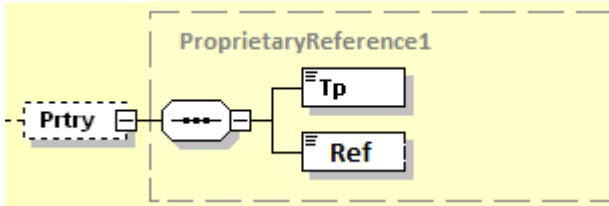

**Presence:** [0..1]

**Definition:** Proprietary reference related to the underlying transaction.

**Type:** *This message item is composed of the following ProprietaryReference1 element(s):*

Index	Or	Message Item	<XML Tag>	Mult.	Represent./ Type
<a href="#">2.154</a>		Type	<Tp>	[1..1]	Text
<a href="#">2.155</a>		Reference	<Ref>	[1..1]	Text

## 2.154 Type <Tp>

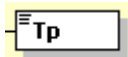

**Presence:** [1..1]

**Definition:** Identifies the type of reference reported.

**Data Type:** Max35Text

**Format:** maxLength: 35  
minLength: 1

## 2.155 Reference <Ref>

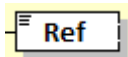

**Presence:** [1..1]

**Definition:** Proprietary reference specification related to the underlying transaction.

**Data Type:** Max35Text

**Format:** maxLength: 35  
minLength: 1

## 2.156 AmountDetails <AmtDtls>

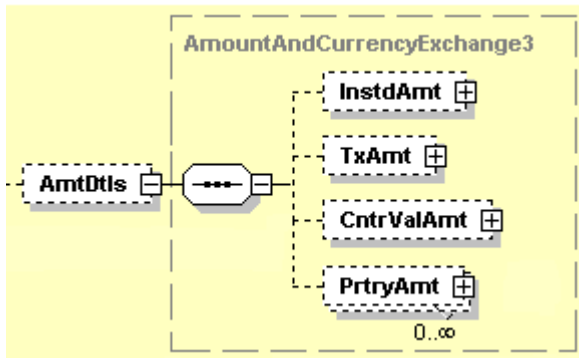

**Presence:** [0..1]

**Definition:** Set of elements providing details information on the original amount.

**Usage:** This component (on transaction level) should be used in case booking is for a single transaction and the original amount is different from the entry amount. It can also be used in case individual original amounts are provided in case of a batch or aggregate booking.

**Type:** *This message item is composed of the following **AmountAndCurrencyExchange3** element(s):*

**BBA Usage:** see 4.6 - Reporting of different kinds of amounts

Ref	Or	Message Item	<XML Tag>	Mult.	Represent./ Type
<a href="#">2.1.0</a>		InstructedAmount	<InstdAmt>	[0..1]	
<a href="#">2.1.1</a>		Amount	<Amt>	[1..1]	Amount
<a href="#">2.1.9</a>		TransactionAmount	<TxAmt>	[0..1]	
<a href="#">2.1.10</a>		Amount	<Amt>	[1..1]	Amount
<a href="#">2.1.18</a>		CounterValueAmount	<CntrValAmt>	[0..1]	
<a href="#">2.1.19</a>		Amount	<Amt>	[1..1]	Amount
<a href="#">2.1.20</a>		CurrencyExchange	<CcyXchg>	[0..1]	
<a href="#">2.1.21</a>		SourceCurrency	<SrcCcy>	[1..1]	Code
<a href="#">2.1.22</a>		TargetCurrency	<TrgtCcy>	[0..1]	Code
<a href="#">2.1.23</a>		UnitCurrency	<UnitCcy>	[0..1]	Code
<a href="#">2.1.24</a>		ExchangeRate	<XchgRate>	[1..1]	Rate
<a href="#">2.1.36</a>		ProprietaryAmount	<PrtryAmt>	[0..n]	
<a href="#">2.1.37</a>		Type	<Tp>	[1..1]	Text
<a href="#">2.1.38</a>		Amount	<Amt>	[1..1]	Amount

## 2.1.0 InstructedAmount <InstdAmt>

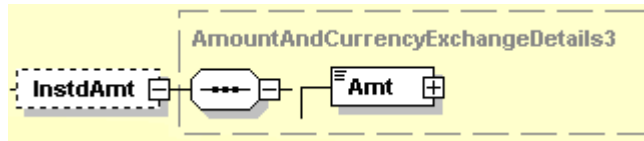

**Presence:** [0..1]

**Definition:** Identifies the amount of money to be moved between the debtor and creditor, before deduction of charges, expressed in the currency as ordered by the initiating party and provides currency exchange info in case the instructed amount and/or currency is/are different from the entry amount and/or currency.

**Type:** *This message item is composed of the following AmountAndCurrencyExchangeDetails3 element(s):*

Ref	Or	Message Item	<XML Tag>	Mult.	Represent./ Type
<a href="#">2.1.0</a>		InstructedAmount	<InstdAmt>	[0..1]	
<a href="#">2.1.1</a>		Amount	<Amt>	[1..1]	Amount

## 2.1.1 Amount <Amt>

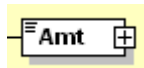

**Presence:** [1..1]

**Definition:** Amount of money to be moved between the debtor and creditor, before deduction of charges, expressed in the currency as ordered by the initiating party.

**Data Type:** CurrencyAndAmount

*This data type must be used with the following XML Attribute: **Currency (Ccy)** which is typed by **CurrencyCode**.*

**Format:** **CurrencyAndAmount**

fractionDigits: 5

minInclusive: 0

totalDigits: 18

**CurrencyCode**

[A-Z]{3,3}

**Rule(s):** **CurrencyCode**

ValidationByTable



## 2.1.9 TransactionAmount <TxAmt>

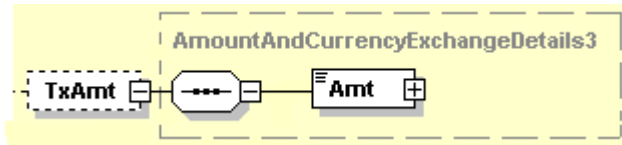

**Presence:** [0..1]

**Definition:** Amount of the underlying transaction.

**Type:** *This message item is composed of the following AmountAndCurrencyExchangeDetails3 element(s):*

## 2.1.10 Amount <Amt>

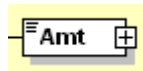

**Presence:** [1..1]

**Definition:** Amount of money to be moved between the debtor and creditor, before deduction of charges, expressed in the currency as ordered by the initiating party.

**Data Type:** ActiveOrHistoricCurrencyAndAmount

*This data type must be used with the following XML Attribute: **Currency (Ccy)** which is typed by*

*ActiveOrHistoricCurrencyCode.*

**Format:** ActiveOrHistoricCurrencyAndAmount

fractionDigits: 5

minInclusive: 0

totalDigits: 18

**ActiveOrHistoricCurrencyCode**

[A-Z]{3,3}

**Rule(s):** ActiveOrHistoricCurrencyAndAmount

CurrencyAmount

### 2.1.18 CounterValueAmount <CntrValAmt>

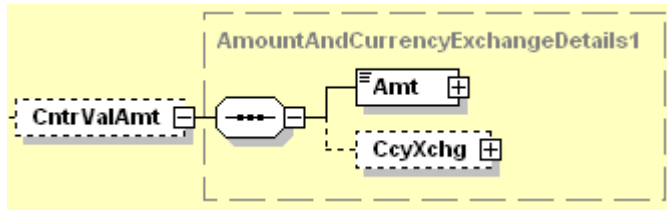

**Presence:** [0..1]

**Definition:** Set of elements used to provide the countervalue amount and currency exchange information.

**Usage:** This can be either the counter amount quoted in an FX deal, or the result of the currency information applied to an instructed amount, before deduction of charges.

**Type:** *This message item is composed of the following AmountAndCurrencyExchangeDetails3 element(s):*

Ref	Or	Message Item	<XML Tag>	Mult.	Represent./ Type
<a href="#">2.1.19</a>		Amount	<Amt>	[1..1]	Amount
<a href="#">2.1.20</a>		CurrencyExchange	<CcyXchg>	[0..1]	

### 2.1.19 Amount <Amt>

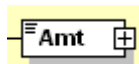

**Presence:** [1..1]

**Definition:** Amount of money to be moved between the debtor and creditor, before deduction of charges, expressed in the currency as ordered by the initiating party.

**Data Type:** CurrencyAndAmount

*This data type must be used with the following XML Attribute: **Currency (Ccy)** which is typed by **CurrencyCode**.*

**Format:** **CurrencyAndAmount**

fractionDigits: 5

minInclusive: 0

totalDigits: 18

**CurrencyCode**

[A-Z]{3,3}

**Rule(s):** **CurrencyCode**

ValidationByTable

## 2.1.20 CurrencyExchange <CcyXchg>

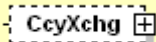

**Presence:** [0..1]

**Definition:** Reports on currency exchange information.

**Type:** *This message item is composed of the following CurrencyExchange5 element(s):*

<a href="#">2.1.21</a>		SourceCurrency	<SrcCcy>	[1..1]	Code
<a href="#">2.1.22</a>		TargetCurrency	<TrgtCcy>	[0..1]	Code
<a href="#">2.1.23</a>		UnitCurrency	<UnitCcy>	[0..1]	Code
<a href="#">2.1.24</a>		ExchangeRate	<XchgRate>	[1..1]	Rate

## 2.1.21 SourceCurrency <SrcCcy>

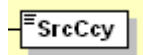

**Presence:** [1..1]

UNIFI (ISO 20022) - Bank-to-Customer Cash Management Standards April 2007

Message Item Types

Page 343

**Definition:** Currency of the amount to be converted in a currency conversion.

**Data Type:** CurrencyCode

**Format:** [A-Z]{3,3}

**Rule(s):** ValidationByTable

## 2.1.22 TargetCurrency <TrgtCcy>

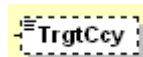

**Presence:** [0..1]

**Definition:** Currency into which an amount is to be converted in a currency conversion.

**Data Type:** CurrencyCode

**Format:** [A-Z]{3,3}

**Rule(s):** ValidationByTable

### 2.1.23 UnitCurrency <UnitCcy>

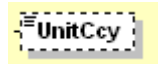

**Presence:** [0..1]  
**Definition:** Currency in which the rate of exchange is expressed in a currency exchange. In the example 1GBP = xxxCUR, the unit currency is GBP.  
**Data Type:** CurrencyCode  
**Format:** [A-Z]{3,3}  
**Rule(s):** ValidationByTable

### 2.1.24 ExchangeRate <XchgRate>



**Synonym(s):** :92A::EXCH (ISO 15022)  
**Presence:** [1..1]  
**Definition:** Factor used for the conversion of an amount from one currency into another. This reflects the price at which one currency was bought with another currency.  
**Usage:** ExchangeRate expresses the ratio between UnitCurrency and QuotedCurrency (ExchangeRate = UnitCurrency/QuotedCurrency).  
**Data Type:** BaseOneRate  
**Format:** fractionDigits: 10  
totalDigits: 11

### 2.1.36 ProprietaryAmount <PrtryAmt>

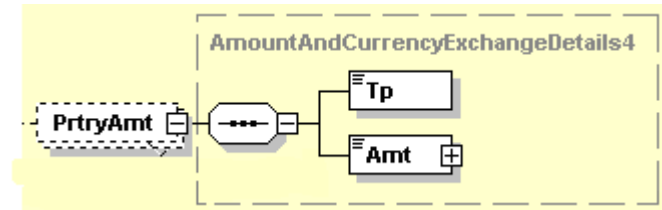

**Presence:** [0..n]  
**Definition:** Set of elements used to provide information on the original amount and currency exchange.  
**Type:** *This message item is composed of the following AmountAndCurrencyExchangeDetails4 element(s):*

Ref	Or	Message Item	<XML Tag>	Mult.	Represent./ Type
<a href="#">2.1.37</a>		Type	<Tp>	[1..1]	Text
<a href="#">2.1.38</a>		Amount	<Amt>	[1..1]	Amount

### 2.1.37 Type <Tp>

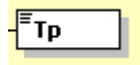

<b>Presence:</b>	[1..1]
<b>Definition:</b>	Specifies the type of amount.
<b>Data Type:</b>	Max35Text
<b>Format:</b>	maxLength: 35 minLength: 1

### 2.1.38 Amount <Amt>

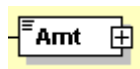

<b>Presence:</b>	[1..1]
<b>Definition:</b>	Amount of money to be exchanged against another amount of money in the counter currency.
<b>Data Type:</b>	ActiveOrHistoricCurrencyAndAmount
	<i>This data type must be used with the following XML Attribute: <b>Currency (Ccy)</b> which is typed by <b>ActiveOrHistoricCurrencyCode</b>.</i>

**Format:** **ActiveOrHistoricCurrencyAndAmount**

fractionDigits: 5

minInclusive: 0

totalDigits: 18

**ActiveOrHistoricCurrencyCode**

[A-Z]{3,3}

**Rule(s):** **ActiveOrHistoricCurrencyAndAmount**

CurrencyAmount

The number of fractional digits (or minor unit of currency) must comply with ISO 4217.

Note: The decimal separator is a dot.

(Fatal) Error Code: Sw.Stds.D00007

**ActiveOrHistoricCurrencyCode**

ActiveOrHistoricCurrency

The Currency Code must be registered, or have already been registered. Valid active or historic currency codes are registered with the ISO 4217 Maintenance Agency, consist of three (3) contiguous letters, and may be or not be withdrawn on the day the message containing the Currency is exchanged.

(Fatal) Error Code: Sw.Stds.D00006

## 2.163 BankTransactionCode <BkTxCd>

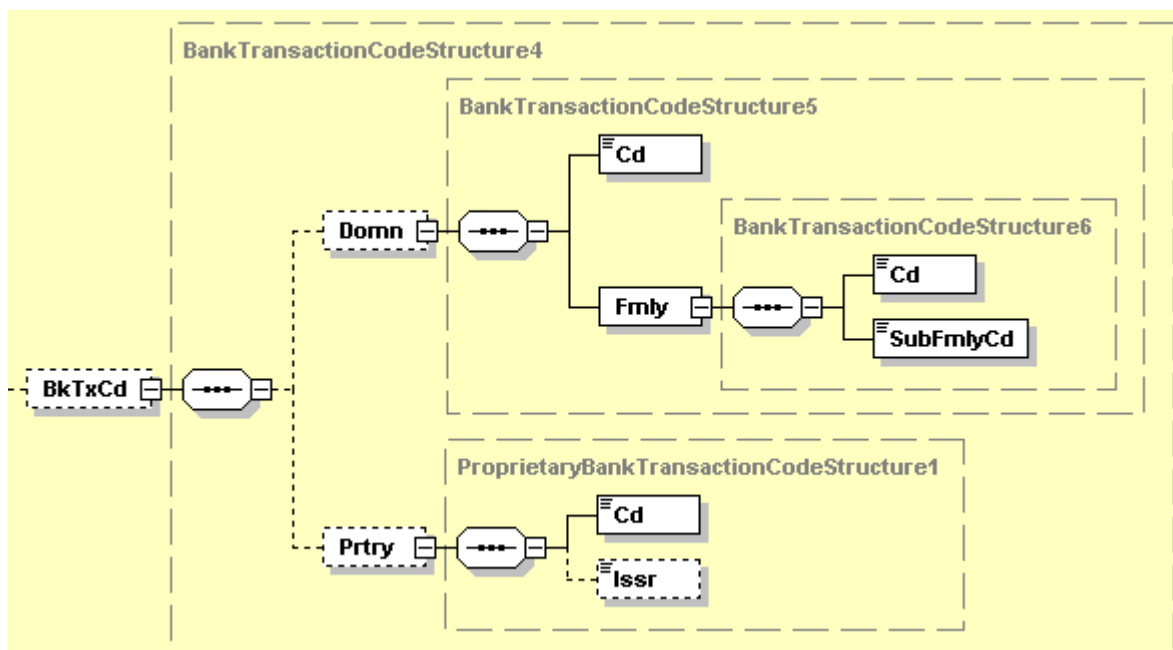

**Presence:** [0..1]

**Definition:** Set of elements used to fully identify the type of underlying transaction resulting in an entry.

**Type:** *This message item is composed of the following **BankTransactionCodeStructure4** element(s):*

**BBA USAGE:** see chapter 5

Index	Or	Message Item	<XML Tag>	Mult.	Represent./ Type
<a href="#">2.164</a>		Domain	<Domn>	[0..1]	
<a href="#">2.169</a>		Proprietary	<Prtry>	[0..1]	

## 2.164 Domain <Domn>



**Presence:** [0..1], R2

**Definition:** Set of elements used to provide the domain, the family and the sub-family of the bank transaction code, in a structured and hierarchical format.

**Usage:** If a specific family or sub-family code cannot be provided, the generic family code defined for the domain or the generic sub-family code defined for the family should be provided.

**Type:** *This message item is composed of the following BankTransactionCodeStructure5 element(s):*

Index	Or	Message Item	<XML Tag>	Mult.	Represent./ Type
<a href="#">2.165</a>		Code	<Cd>	[1..1]	Code
<a href="#">2.166</a>		Family	<Fmly>	[1..1]	

## 2.165 Code <Cd>

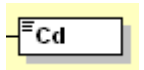

**Presence:** [1..1]

**Definition:** Specifies the business area of the underlying transaction.

**Data Type:** ExternalBankTransactionDomainCode

**Format:** maxLength: 4  
minLength: 1

## 2.166 Family <Fmly>



**Presence:** [1..1]

**Definition:** Specifies the family and the sub-family of the bank transaction code, within a specific domain, in a structured and hierarchical format.

**Type:** *This message item is composed of the following BankTransactionCodeStructure6 element(s):*

Index	Or	Message Item	<XML Tag>	Mult.	Represent./ Type
<a href="#">2.167</a>		Code	<Cd>	[1..1]	Code
<a href="#">2.168</a>		SubFamilyCode	<SubFmlyCd>	[1..1]	Code

## 2.167 Code <Cd>

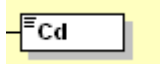

**Presence:** [1..1]  
**Definition:** Specifies the family within a domain.  
**Data Type:** ExternalBankTransactionFamilyCode  
**Format:** maxLength: 4  
 minLength: 1

## 2.168 SubFamilyCode <SubFmlyCd>



**Presence:** [1..1]  
**Definition:** Specifies the sub-product family within a specific family.  
**Data Type:** ExternalBankTransactionSubFamily1Code  
**Format:** maxLength: 4  
 minLength: 1

## 2.169 Proprietary <Prtry>

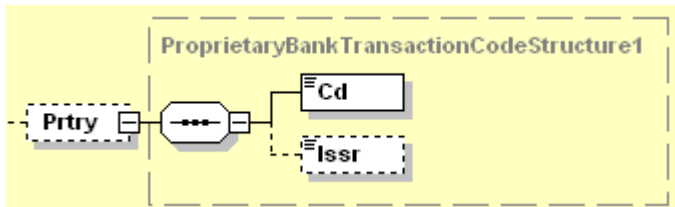

**Presence:** [0..1], R2  
**Definition:** Bank transaction code in a proprietary form, as defined by the issuer.  
**Type:** *This message item is composed of the following ProprietaryBankTransactionCodeStructure1 element(s):*

**BBA USAGE:** The BBA Bank Transaction Code will be specified for each transaction (see 5.2)

Index	Or	Message Item	<XML Tag>	Mult.	Represent./ Type
<a href="#">2.170</a>		Code	<Cd>	[1..1]	Text
<a href="#">2.171</a>		Issuer	<Issr>	[0..1]	Text



## 2.170 Code <Cd>

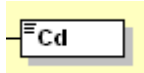

<b>Presence:</b>	[1..1]
<b>Definition:</b>	Proprietary bank transaction code to identify the underlying transaction.
<b>Data Type:</b>	Max35Text
<b>Format:</b>	maxLength: 35 minLength: 1

## 2.171 Issuer <Issr>



<b>Presence:</b>	[0..1]
<b>Definition:</b>	Identification of the issuer of the proprietary bank transaction code.
<b>Data Type:</b>	Max35Text
<b>Format:</b>	maxLength: 35 minLength: 1

## 2.172 Charges <Chrgs>

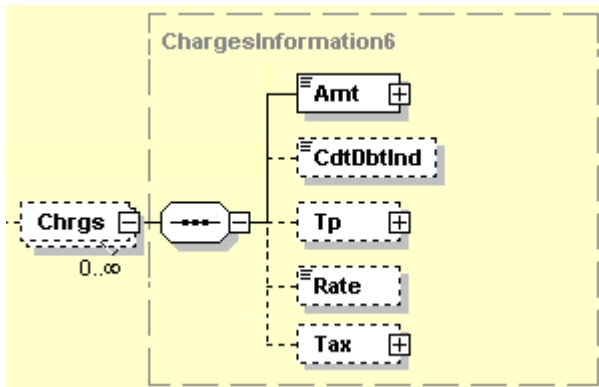

**Presence:** [0..n]

**Definition:** Provides information on the charges included in the entry amount.

**Usage:** This component is used on entry level in case of batch or aggregate bookings.

**Type:** *This message item is composed of the following **ChargesInformation6** element(s):*

Index	Or	Message Item	<XML Tag>	Mult.	Represent./ Type
<a href="#">2.174</a>		Amount	<Amt>	[1..1]	Amount
<a href="#">2.175</a>		CreditDebitIndicator	<CdtDbtInd>	[0..1]	Code
<a href="#">2.176</a>		Type	<Tp>	[0..1]	
<a href="#">2.179</a>		Rate	<Rate>	[0..1]	Rate
<a href="#">2.182</a>		Tax	<Tax>	[0..1]	

## 2.174 Amount <Amt>

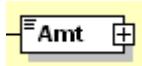

**Presence:** [1..1]

**Definition:** Transaction charges to be paid by the charge bearer.

**Data Type:** ActiveOrHistoricCurrencyAndAmount

*This data type must be used with the following XML Attribute: **Currency (Ccy)** which is typed by **ActiveOrHistoricCurrencyCode**.*

**Format:** **ActiveOrHistoricCurrencyAndAmount**

fractionDigits: 5

minInclusive: 0

totalDigits: 18

**ActiveOrHistoricCurrencyCode**

[A-Z]{3,3}

**Rule(s):** **ActiveOrHistoricCurrencyAndAmount**

CurrencyAmount

The number of fractional digits (or minor unit of currency) must comply with ISO 4217.

Note: The decimal separator is a dot.

(Fatal) Error Code: Sw.Stds.D00007

**ActiveOrHistoricCurrencyCode**

ActiveOrHistoricCurrency

The Currency Code must be registered, or have already been registered. Valid active or historic currency codes are registered with the ISO 4217 Maintenance Agency, consist of three (3) contiguous letters, and may be or not be withdrawn on the day the message containing the Currency is exchanged.

(Fatal) Error Code: Sw.Stds.D00006

## 2.175 CreditDebitIndicator <CdtDbtInd>



**Presence:** [0..1]

**Definition:** Indicates whether the charges amount is a credit or a debit amount.

Usage: A zero amount is considered to be a credit.

**Data Type:** Code

*When this message item is present, one of the following **CreditDebitCode** values must be used:*

Code	Name	Definition
CRDT	Credit	Operation is an increase.
DBIT	Debit	Operation is a decrease.

## 2.176 Type <Tp>

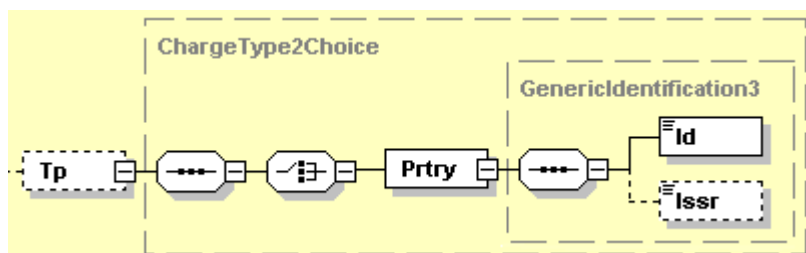

**Presence:** [0..1]

**Definition:** Specifies the type of charge.

**Type:** *This message item is composed of the following **ChargeType2Choice** element:*

Index	Or	Message Item	<XML Tag>	Mult.	Represent./ Type
<u>2.178</u>		Proprietary	<Prtry>	[1..1]	±

## 2.178 Proprietary <Prtry>

**Presence:** [1..1]

*This message item is part of choice 2.176 Type.*

**Definition:** Type of charge in a proprietary form, as defined by the issuer.

**Type:** *This message item is composed of the following **GenericIdentification3** element(s):*

Ref	Or	Message Item	<XML Tag>	Mult.	Represent./ Type
<u>7.1.0</u>		Identification	<Id>	[1..1]	Text
<u>7.1.1</u>		Issuer	<Issr>	[0..1]	Text

### 7.1.0 Identification <Id>



**Presence:** [1..1]

**Definition:** Name or number assigned by an entity to enable recognition of that entity, eg, account identifier.

**Data Type:** Max35Text

**Format:** maxLength: 35  
minLength: 1

**BBA USAGE:** Use the codes that are mentioned for the different categories – cf. annex 6.2 - Category.

### 7.1.1 Issuer <Issr>



**Presence:** [0..1]  
**Definition:** Entity that assigns the identification.  
**Data Type:** Max35Text  
**Format:** maxLength: 35  
 minLength: 1

### 2.179 Rate <Rate>

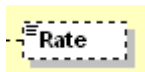

**Presence:** [0..1]  
**Definition:** Rate used to calculate the amount of the charge or fee.  
**Data Type:** PercentageRate  
**Format:** fractionDigits: 10  
 totalDigits: 11

### 2.182 Tax <Tax>

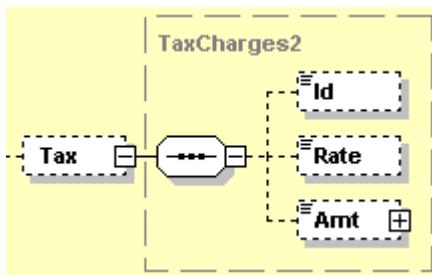

**Presence:** [0..1]  
**Definition:** Set of elements used to provide details on the tax applied to charges.  
**Type:** *This message item is composed of the following **TaxCharges2** element(s):*

Index	Or	Message Item	<XML Tag>	Mult.	Represent./ Type
<a href="#">2.183</a>		Identification	<Id>	[0..1]	Text
<a href="#">2.184</a>		Rate	<Rate>	[0..1]	Rate
<a href="#">2.185</a>		Amount	<Amt>	[0..1]	Amount

## 2.183 Identification <Id>

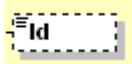

<b>Presence:</b>	[0..1]
<b>Definition:</b>	Unique reference to unambiguously identify the nature of the tax levied, such as Value Added Tax (VAT)
<b>Data Type:</b>	Max35Text
<b>Format:</b>	maxLength: 35 minLength: 1
<b><u>BBA USAGE:</u></b>	Use the category code (cf. annex 6.2 - Category) .

## 2.184 Rate <Rate>

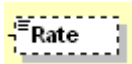

<b>Definition:</b>	Rate used to calculate the tax.
<b>Data Type:</b>	PercentageRate
<b>Format:</b>	fractionDigits: 10 totalDigits: 11

## 2.185 Amount <Amt>

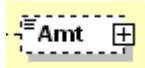

**Presence:** [0..1]

**Definition:** Amount of money resulting from the calculation of the tax.

**Data Type:** ActiveOrHistoricCurrencyAndAmount

*This data type must be used with the following XML Attribute: **Currency (Ccy)** which is typed by **ActiveOrHistoricCurrencyCode**.*

**Format:** **ActiveOrHistoricCurrencyAndAmount**

fractionDigits: 5

minInclusive: 0

totalDigits: 18

**ActiveOrHistoricCurrencyCode**

[A-Z]{3,3}

**Rule(s):** **ActiveOrHistoricCurrencyAndAmount**

CurrencyAmount

The number of fractional digits (or minor unit of currency) must comply with ISO 4217.

Note: The decimal separator is a dot.

(Fatal) Error Code: Sw.Stds.D00007

**ActiveOrHistoricCurrencyCode**

ActiveOrHistoricCurrency

The Currency Code must be registered, or have already been registered. Valid active or historic currency codes are registered with the ISO 4217 Maintenance Agency, consist of three (3) contiguous letters, and may be or not be withdrawn on the day the message containing the Currency is exchanged.

(Fatal) Error Code: Sw.Stds.D00006

## 2.186 Interest <Intrst>

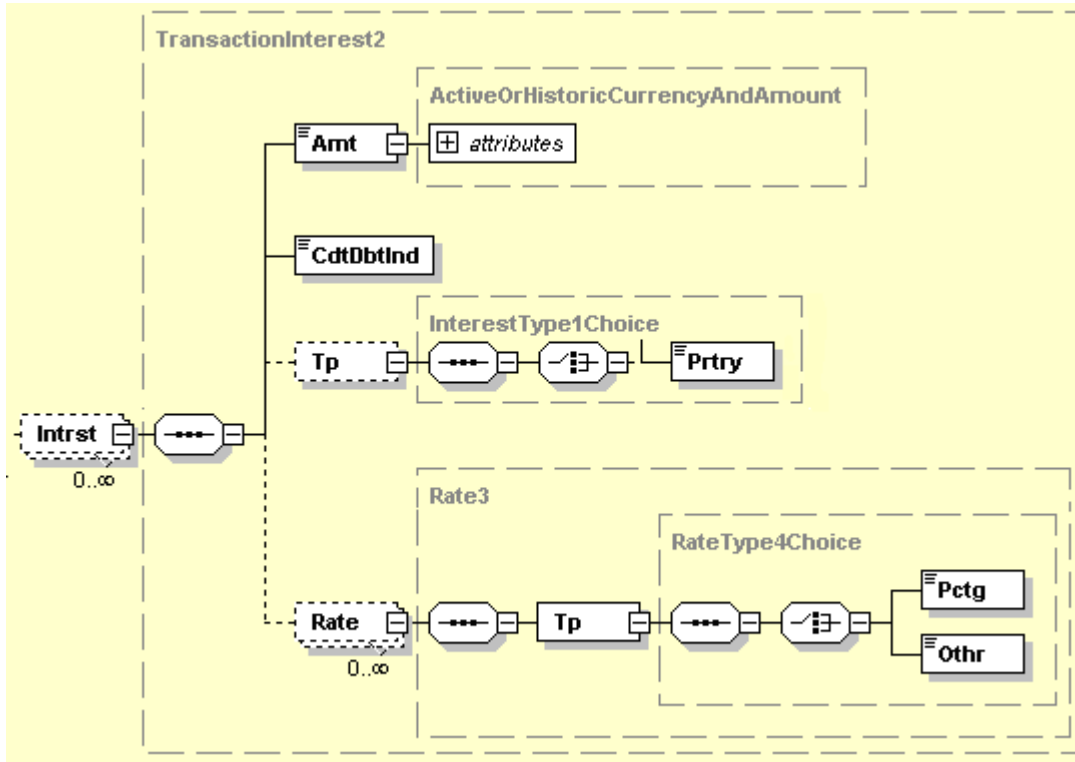

**Presence:** [0..n]

**Definition:** Set of elements used to provide details of the interest amount included in the entry amount.

**Usage:** This component (on transaction level) can be used if the booking is for a single transaction, and interest amount is included in the entry amount. It can also be used if individual interest amounts are applied to individual transactions in the case of a batch or aggregate amount booking.

**Type:** *This message item is composed of the following **TransactionInterest2** element(s):*

Index	Or	Message Item	<XML Tag>	Mult.	Represent./ Type
<a href="#">2.187</a>		Amount	<Amt>	[1..1]	Amount
<a href="#">2.188</a>		CreditDebitIndicator	<CdtDbtInd>	[1..1]	Code
<a href="#">2.189</a>		Type	<Tp>	[0..1]	
<a href="#">2.192</a>		Rate	<Rate>	[0..n]	
<a href="#">2.197</a>		FromToDate	<FrToDt>	[0..1]	±



## 2.187 Amount <Amt>



**Presence:** [1..1]

**Definition:** Amount of interest included in the entry amount.

**Data Type:** ActiveOrHistoricCurrencyAndAmount

*This data type must be used with the following XML Attribute: **Currency (Ccy)** which is typed by **ActiveOrHistoricCurrencyCode**.*

**Format:** **ActiveOrHistoricCurrencyAndAmount**

fractionDigits: 5

minInclusive: 0

totalDigits: 18

**ActiveOrHistoricCurrencyCode**

[A-Z]{3,3}

**Rule(s):** **ActiveOrHistoricCurrencyAndAmount**

CurrencyAmount

The number of fractional digits (or minor unit of currency) must comply with ISO 4217.

Note: The decimal separator is a dot.

(Fatal) Error Code: Sw.Stds.D00007

**ActiveOrHistoricCurrencyCode**

ActiveOrHistoricCurrency

The Currency Code must be registered, or have already been registered. Valid active or historic currency codes are registered with the ISO 4217 Maintenance Agency, consist of three (3) contiguous letters, and may be or not be withdrawn on the day the message containing the Currency is exchanged.

(Fatal) Error Code: Sw.Stds.D00006

## 2.188 CreditDebitIndicator <CdtDbtInd>



**Presence:** [1..1]

**Definition:** Indicates whether the interest amount included in the entry is credit or debit amount.

**Data Type:** Code

*One of the following **CreditDebitCode** values must be used:*

Code	Name	Definition
CRDT	Credit	Operation is an increase.
DBIT	Debit	Operation is a decrease.

## 2.189 Type <Tp>

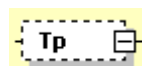

**Presence:** [0..1]

**Definition:** Specifies the type of interest.

**Type:** *This message item is composed of the following InterestType1Choice element:*

Index	Or	Message Item	<XML Tag>	Mult.	Represent./ Type
2.191		Proprietary	<Prtry>	[1..1]	Text

## 2.191 Proprietary <Prtry>



**Presence:** [1..1]

*This message item is part of choice 2.189 Type.*

**Definition:** Specifies the type of interest in uncoded form.

**Data Type:** Max35Text

**Format:** maxLength: 35  
minLength: 1

**BBA USAGE:** Use the category code (cf. annex 6.2 - Category) .

## 2.192 Rate <Rate>

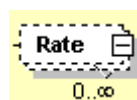

**Presence:** [0..n]

**Definition:** Set of elements used to qualify the interest rate.

**Type:** *This message item is composed of the following Rate3 element(s):*

Index	Or	Message Item	<XML Tag>	Mult.	Represent./ Type
2.193		Type	<Tp>	[1..1]	

## 2.193 Type <Tp>

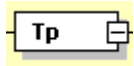

**Presence:** [1..1]

**Definition:** Specifies the type of interest rate.

**Type:** *This message item is composed of one of the following **RateType4Choice** element(s):*

Index	Or	Message Item	<XML Tag>	Mult.	Represent./ Type
<a href="#">2.194</a>	{Or	Percentage	<Pctg>	[1..1]	Rate
<a href="#">2.195</a>	Or}	Other	<Othr>	[1..1]	Text

## 2.194 Percentage <Pctg>

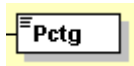

**Presence:** [1..1]

*This message item is part of choice 2.193 Type.*

**Definition:** Ratio of the amount of interest paid during a certain period of time compared to the principal amount of the interest bearing financial instrument.

**Data Type:** PercentageRate

**Format:** fractionDigits: 10  
totalDigits: 11

## 2.195 Other <Othr>

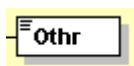

**Presence:** [1..1]

*This message item is part of choice 2.193 Type.*

**Definition:** Rate type expressed, in an other form.

**Data Type:** Max35Text

**Format:** maxLength: 35  
minLength: 1

## 2.197 FromToDate <FrToDt>

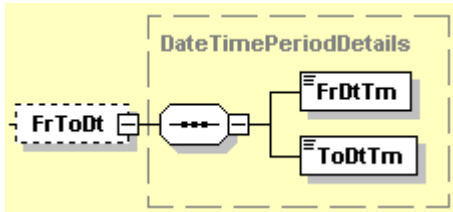

**Presence:** [0..1]

**Definition:** Range of time between a start date and an end date for the calculation of the interest.

**Type:** *This message item is composed of the following **DateTimePeriodDetails** element(s):*

*For additional Type information, please refer to **DateTimePeriodDetails** p.611 in 'Message Item Types' section.*

Ref	Or	Message Item	<XML Tag>	Mult.	Represent./ Type
<u>5.1.0</u>		FromDateTime	<FrDtTm>	[1..1]	DateTime
<u>5.1.1</u>		ToDateTime	<ToDtTm>	[1..1]	DateTime

### 5.1.0 FromDateTime <FrDtTm>



**Presence:** [1..1]

**Definition:** Date and time at which the range starts.

**Data Type:** ISODateTime

### 5.1.1 ToDateTime <ToDtTm>



**Presence:** [1..1]

**Definition:** Date and time at which the range ends.

**Data Type:** ISODateTime

## 2.199 RelatedParties <RltdPties>

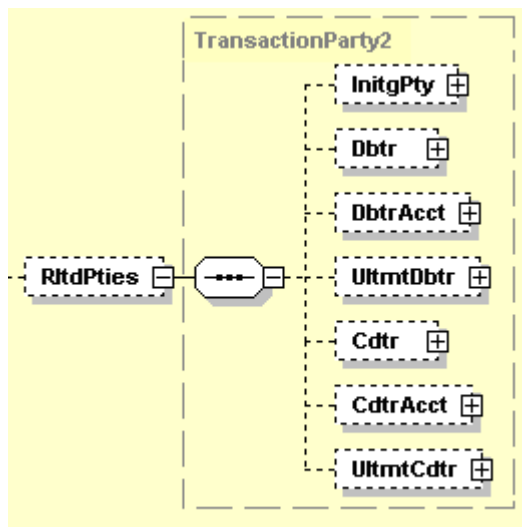

**Presence:** [0..1]

**Definition:** Set of elements used to identify the parties related to the underlying transaction.

Type: *This message item is composed of the following **TransactionParty2** element(s):*

Index	Or	Message Item	<XML Tag>	Mult.	Represent./ Type
<a href="#">2.200</a>		InitiatingParty	<InitgPty>	[0..1]	±
<a href="#">2.201</a>		Debtor	<Dbtr>	[0..1]	±
<a href="#">2.202</a>		DebtorAccount	<DbtrAcct>	[0..1]	±
<a href="#">2.203</a>		UltimateDebtor	<UltmtDbtr>	[0..1]	±
<a href="#">2.204</a>		Creditor	<Cdtr>	[0..1]	±
<a href="#">2.205</a>		CreditorAccount	<CdtrAcct>	[0..1]	±
<a href="#">2.206</a>		UltimateCreditor	<UltmtCdtr>	[0..1]	±

## 2.200 InitiatingParty <InitgPty>

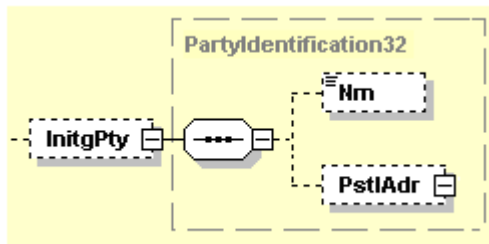

**Presence:** [0..1]

**Definition:** Party that initiated the payment that is reported in the entry.

**Type:** *This message item is composed of the following PartyIdentification32 element(s):*

Ref	Or	Message Item	<XML Tag>	Mult.	Represent./ Type
<u>9.1.0</u>		Name	<Nm>	[0..1]	Text
<u>9.1.1</u>		PostalAddress	<PstlAdr>	[0..1]	

### 9.1.0 Name <Nm>



**Presence:** [0..1]

**Definition:** Name by which a party is known and which is usually used to identify that party.

**Data Type:** Max140Text

**Format:** maxLength: 140  
minLength: 1

### 9.1.1 PostalAddress <PstIAdr>

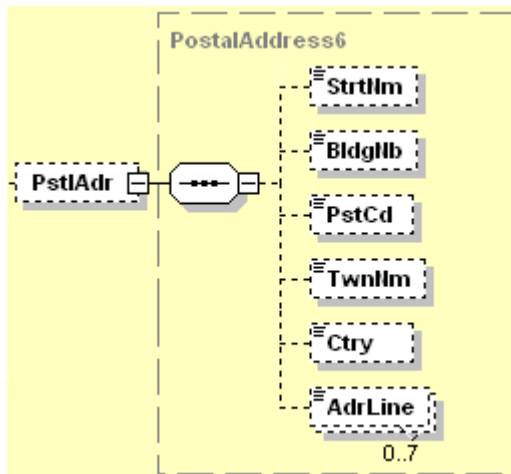

**Presence:** [0..1]

**Definition:** Information that locates and identifies a specific address, as defined by postal services.

**Type:** *This message item is composed of the following **PostalAddress6** element(s):*

Ref	Or	Message Item	<XML Tag>	Mult.	Represent./ Type
<a href="#">9.1.5</a>		StreetName	<StrtNm>	[0..1]	Text
<a href="#">9.1.6</a>		BuildingNumber	<BldgNb>	[0..1]	Text
<a href="#">9.1.7</a>		PostCode	<PstCd>	[0..1]	Text
<a href="#">9.1.8</a>		TownName	<TwnNm>	[0..1]	Text
<a href="#">9.1.10</a>		Country	<Ctry>	[0..1]	Code
<a href="#">9.1.11</a>		AddressLine	<AdrLine>	[0..7]	Text

### 9.1.5 StreetName <StrtNm>

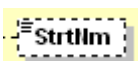

**Presence:** [0..1]

**Definition:** Name of a street or thoroughfare.

**Data Type:** Max70Text

**Format:** maxLength: 70  
minLength: 1

### 9.1.6 BuildingNumber <BldgNb>



<b>Presence:</b>	[0..1]
<b>Definition:</b>	Number that identifies the position of a building on a street.
<b>Data Type:</b>	Max16Text
<b>Format:</b>	maxLength: 16 minLength: 1

### 9.1.7 PostCode <PstCd>

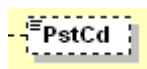

<b>Presence:</b>	[0..1]
<b>Definition:</b>	Identifier consisting of a group of letters and/or numbers that is added to a postal address to assist the sorting of mail.
<b>Data Type:</b>	Max16Text
<b>Format:</b>	maxLength: 16 minLength: 1

### 9.1.8 TownName <TwnNm>



<b>Presence:</b>	[0..1]
<b>Definition:</b>	Name of a built-up area, with defined boundaries, and a local government.
<b>Data Type:</b>	Max35Text
<b>Format:</b>	maxLength: 35 minLength: 1

### 9.1.10 zcountry <Ctry>

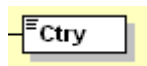

<b>Presence:</b>	[0..1]
<b>Definition:</b>	Nation with its own government.
<b>Data Type:</b>	CountryCode
<b>Format:</b>	[A-Z]{2,2}
<b>Rule(s):</b>	Country

The code is checked against the list of country names obtained from the United Nations (ISO 3166, Alpha-2 code).



### 9.1.11 AddressLine <AdrLine>

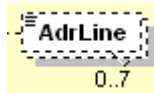

**Presence:** [0..7]

**Definition:** Information that locates and identifies a specific address, as defined by postal services, presented in free format text.

**Data Type:** Max70Text

**Format:** maxLength: 70  
minLength: 1

## 2.201 Debtor <Dbtr>

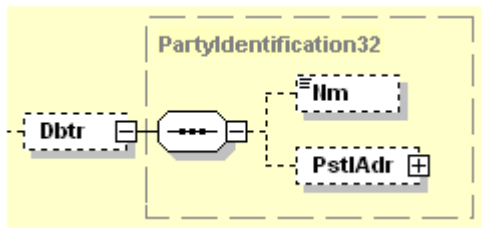

**Presence:** [0..1]

**Definition:** Party that owes an amount of money to the (ultimate) creditor.

**Type:** *This message item is composed of the following **PartyIdentification32** element(s):*

*For additional Type information, please refer to **PartyIdentification32** p.882 in 'Message Item Types' section.*

Ref	Or	Message Item	<XML Tag>	Mult.	Represent./ Type
<a href="#">9.1.0</a>		Name	<Nm>	[0..1]	Text
<a href="#">9.1.1</a>		PostalAddress	<PstlAdr>	[0..1]	
<a href="#">9.1.12</a>		Identification	<Id>	[0..1]	

### 9.1.0 Name <Nm>

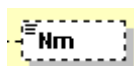

**Presence:** [0..1]

**Definition:** Name by which a party is known and which is usually used to identify that party.

**Data Type:** Max140Text

**Format:** maxLength: 140  
minLength: 1

### 9.1.1 PostalAddress <PstIAdr>

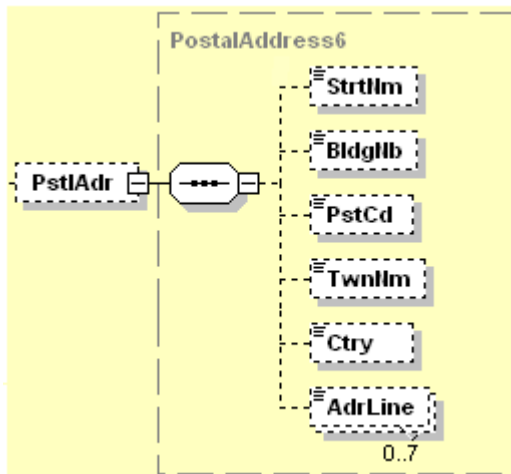

**Presence:** [0..1]

**Definition:** Information that locates and identifies a specific address, as defined by postal services.

**Type:** *This message item is composed of the following **PostalAddress6** element(s):*

Ref	Or	Message Item	<XML Tag>	Mult.	Represent./ Type
<a href="#">9.1.5</a>		StreetName	<StrtNm>	[0..1]	Text
<a href="#">9.1.6</a>		BuildingNumber	<BldgNb>	[0..1]	Text
<a href="#">9.1.7</a>		PostCode	<PstCd>	[0..1]	Text
<a href="#">9.1.8</a>		TownName	<TwnNm>	[0..1]	Text
<a href="#">9.1.10</a>		Country	<Ctry>	[0..1]	Code
<a href="#">9.1.11</a>		AddressLine	<AdrLine>	[0..7]	Text

### 9.1.5 StreetName <StrtNm>

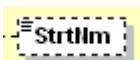

**Presence:** [0..1]

**Definition:** Name of a street or thoroughfare.

**Data Type:** Max70Text

**Format:** maxLength: 70  
minLength: 1

### 9.1.6 BuildingNumber <BldgNb>



**Presence:** [0..1]  
**Definition:** Number that identifies the position of a building on a street.  
**Data Type:** Max16Text  
**Format:** maxLength: 16  
minLength: 1

### 9.1.7 PostCode <PstCd>

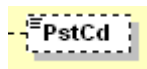

**Presence:** [0..1]  
**Definition:** Identifier consisting of a group of letters and/or numbers that is added to a postal address to assist the sorting of mail.  
**Data Type:** Max16Text  
**Format:** maxLength: 16  
minLength: 1

### 9.1.8 TownName <TwnNm>



**Presence:** [0..1]  
**Definition:** Name of a built-up area, with defined boundaries, and a local government.  
**Data Type:** Max35Text  
**Format:** maxLength: 35  
minLength: 1

### 9.1.10 Country <Ctry>

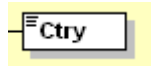

<b>Presence:</b>	[0..1]
<b>Definition:</b>	Nation with its own government.
<b>Data Type:</b>	CountryCode
<b>Format:</b>	[A-Z]{2,2}
<b>Rule(s):</b>	Country

The code is checked against the list of country names obtained from the United Nations (ISO 3166, Alpha-2 code).

### 9.1.11 AddressLine <AdrLine>

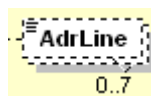

<b>Presence:</b>	[0..7]
<b>Definition:</b>	Information that locates and identifies a specific address, as defined by postal services, presented in free format text.
<b>Data Type:</b>	Max70Text
<b>Format:</b>	maxLength: 70 minLength: 1

### 9.1.12 Identification <Id>

<b>Presence:</b>	[0..1]
<b>Definition:</b>	Unique and unambiguous identification of a party.
<b>Type:</b>	<i>This message item is composed of one of the following <b>Party6Choice</b> element(s):</i>

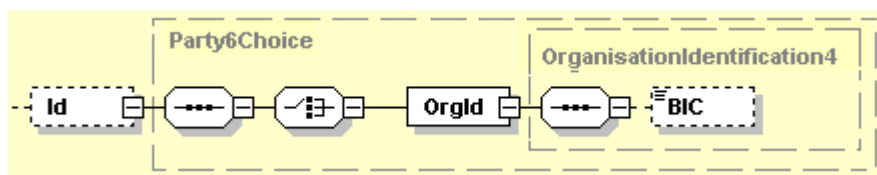

### 9.1.13 OrganisationIdentification <OrgId>



**Presence:** [1..1]

*This message item is part of choice 9.1.12 Identification.*

**Definition:** Unique and unambiguous way to identify an organisation.

**Type:** *This message item is composed of the following OrganisationIdentification4 element(s):*

Ref	Or	Message Item	<XML Tag>	Mult.	Represent./ Type
<u>9.1.14</u>		BICOrBEI	<BICOrBEI>	[0..1]	Identifier

### .1.1 9.1.14 BICOrBEI <BICOrBEI>



**Presence:** [0..1]

**Definition:** Code allocated to organisations by the ISO 9362 Registration Authority, under an international identification scheme, as described in the latest version of the standard ISO 9362 Banking (Banking telecommunication messages, Bank Identifier Codes).

The Ba

**Data Type:** AnyBICIdentifier

**Format:** [A-Z]{6,6}[A-Z2-9][A-NP-Z0-9]([A-Z0-9]{3,3}){0,1}

**Rule(s):** AnyBIC

Only a valid BIC or BEI is allowed. Valid BEI and BIC are registered with the ISO 9362 Registration Authority, and consists of eight (8) or eleven (11) contiguous characters comprising the first three or all four of the following components: BANK CODE, COUNTRY CODE, LOCATION CODE, BRANCH CODE. The bank code, country code and location code are mandatory, while the branch code is optional.

(Fatal) Error Code: Sw.Stds.D00008

## 2.202 DebtorAccount <DbtrAcct>

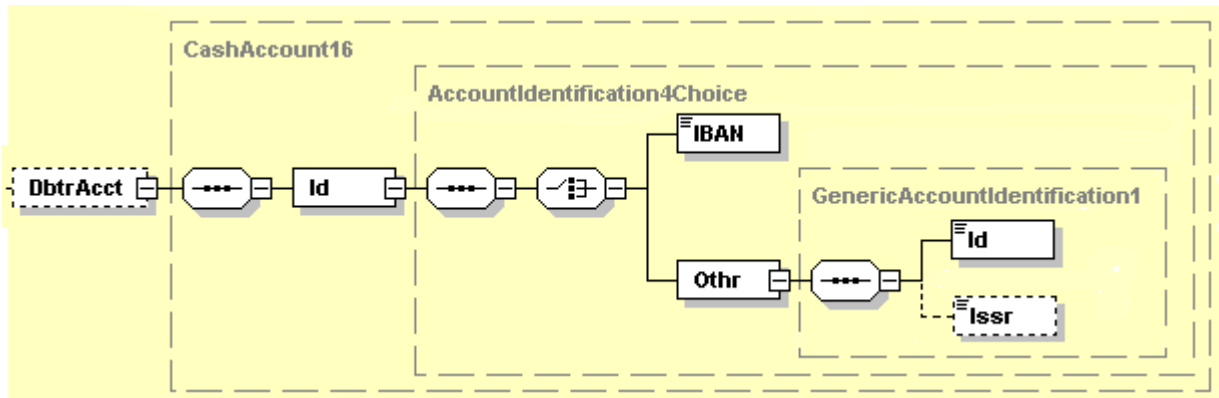

**Presence:** [0..1]

**Definition:** Identifies the parent account of the account for which the statement has been issued.

**Type:** *This message item is composed of the following CashAccount16 element(s):*

Ref	Or	Message Item	<XML Tag>	Mult.	Represent./ Type
1.1.0		Identification	<Id>	[1..1]	
1.1.1	{Or	IBAN	<IBAN>	[1..1]	Identifier
1.1.2	Or}	Other	<Othr>	[1..1]	
1.1.3		Identification	<Id>	[1..1]	Text
1.1.7		Issuer	<Issr>	[0..1]	Text

### 1.1.0 Identification <Id>

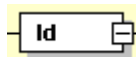

**Presence:** [1..1]

**Definition:** Unique and unambiguous identification for the account between the account owner and the account servicer.

**Type:** *This message item is composed of one of the following AccountIdentification4Choice element(s):*

### 1.1.1 IBAN <IBAN>

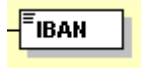

**Presence:** [1..1]

*This message item is part of choice 1.1.0 Identification.*

**Definition:** International Bank Account Number (IBAN) - identifier used internationally by financial institutions to uniquely identify the account of a customer. Further specifications of the format and content of the IBAN can be found in the standard ISO 13616 "Banking and related financial services - International Bank Account

Number (IBAN)" version 1997-10-01, or later revisions.

**Data Type:** IBAN2007Identifier

**Format:** [A-Z]{2,2}[0-9]{2,2}[a-zA-Z0-9]{1,30}

**Rule(s):** IBAN

A valid IBAN consists of all three of the following components: Country Code, check digits and BBAN.

(Fatal) Error Code: Sw.Stds.D00003

Ref	Or	Message Item	<XML Tag>	Mult.	Represent./ Type
<u>1.1.1</u>		IBAN	<IBAN>	[1..1]	Identifier

### 1.1.2 Other <Othr>

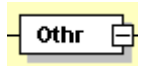

**Presence:** [1..1]

*This message item is part of choice 1.1.0 Identification.*

**Definition:** Unique identification of an account, as assigned by the account servicer, using an identification scheme.

**Type:** *This message item is composed of the following GenericAccountIdentification1 element(s):*

### 1.1.3 Identification <Id>

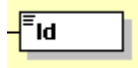

**Presence:** [1..1]  
**Definition:** Identification assigned by an institution.  
**Data Type:** Max34Text  
**Format:** maxLength: 34  
minLength: 1

### 1.1.7 Issuer <Issr>

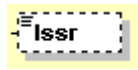

**Presence:** [0..1]  
**Definition:** Entity that assigns the identification.  
**Data Type:** Max35Text  
**Format:** maxLength: 35  
minLength: 1



## 2.203 UltimateDebtor <UltmtDbtr>

**Presence:** [0..1]

**Definition:** Ultimate party that owes an amount of money to the (ultimate) creditor.

**Type:** *This message item is composed of the following **PartyIdentification32** element(s):*

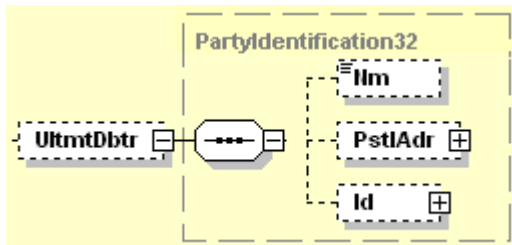

### 9.1.1.0 Name <Nm>



**Presence:** [0..1]

**Definition:** Name by which a party is known and which is usually used to identify that party.

**Data Type:** Max140Text

**Format:** maxLength: 140  
minLength: 1

### 9.1.1 PostalAddress <PstAdr>

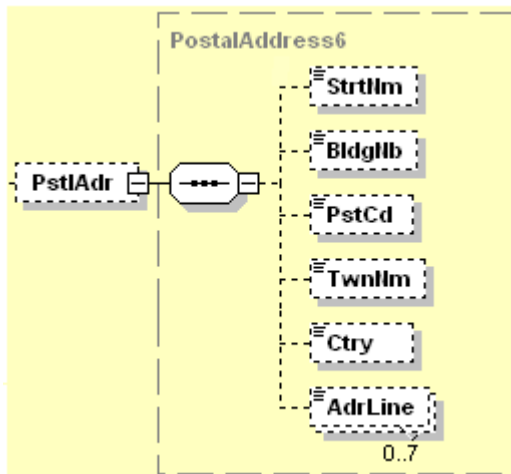

**Presence:** [0..1]

**Definition:** Information that locates and identifies a specific address, as defined by postal services.

**Type:** *This message item is composed of the following **PostalAddress6** element(s):*

Ref	Or	Message Item	<XML Tag>	Mult.	Represent./ Type
<a href="#">9.1.5</a>		StreetName	<StrtNm>	[0..1]	Text
<a href="#">9.1.6</a>		BuildingNumber	<BldgNb>	[0..1]	Text
<a href="#">9.1.7</a>		PostCode	<PstCd>	[0..1]	Text
<a href="#">9.1.8</a>		TownName	<TwnNm>	[0..1]	Text
<a href="#">9.1.10</a>		Country	<Ctry>	[0..1]	Code
<a href="#">9.1.11</a>		AddressLine	<AdrLine>	[0..7]	Text

### 9.1.5 StreetName <StrtNm>

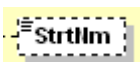

**Presence:** [0..1]

**Definition:** Name of a street or thoroughfare.

**Data Type:** Max70Text

**Format:** maxLength: 70  
minLength: 1

### 9.1.6 BuildingNumber <BldgNb>



<b>Presence:</b>	[0..1]
<b>Definition:</b>	Number that identifies the position of a building on a street.
<b>Data Type:</b>	Max16Text
<b>Format:</b>	maxLength: 16 minLength: 1

### 9.1.7 PostCode <PstCd>

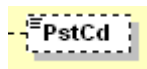

<b>Presence:</b>	[0..1]
<b>Definition:</b>	Identifier consisting of a group of letters and/or numbers that is added to a postal address to assist the sorting of mail.
<b>Data Type:</b>	Max16Text
<b>Format:</b>	maxLength: 16 minLength: 1

### 9.1.8 TownName <TwnNm>



<b>Presence:</b>	[0..1]
<b>Definition:</b>	Name of a built-up area, with defined boundaries, and a local government.
<b>Data Type:</b>	Max35Text
<b>Format:</b>	maxLength: 35 minLength: 1

### 9.1.10 Country <Ctry>

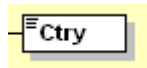

<b>Presence:</b>	[0..1]
<b>Definition:</b>	Nation with its own government.
<b>Data Type:</b>	CountryCode
<b>Format:</b>	[A-Z]{2,2}
<b>Rule(s):</b>	Country

The code is checked against the list of country names obtained from the United Nations (ISO 3166, Alpha-2 code).

### 9.1.11 AddressLine <AdrLine>

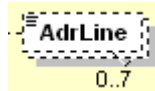

**Presence:** [0..7]

**Definition:** Information that locates and identifies a specific address, as defined by postal services, presented in free format text.

**Data Type:** Max70Text

**Format:** maxLength: 70  
minLength: 1

### 9.1.12 Identification <Id>



**Presence:** [0..1]

**Definition:** Unique and unambiguous identification of a party

**Type:** *This message item is composed of one of the following Party6Choice element(s):*

Ref	Or	Message Item	<XML Tag>	Mult.	Represent./ Type
<a href="#">9.1.13</a>		OrganisationIdentification	<OrgId>	[1..1]	

### 9.1.13 OrganisationIdentification <OrgId>



**Presence:** [1..1]

*This message item is part of choice 9.1.12 Identification.*

**Definition:** Unique and unambiguous way to identify an organisation

**Type:** *This message item is composed of the following OrganisationIdentification4 element(s):*

Ref	Or	Message Item	<XML Tag>	Mult.	Represent./ Type
<a href="#">9.1.14</a>		BICOrBEI	<BICOrBEI>	[0..1]	Identifier
<a href="#">9.1.15</a>		Other	<Othr>	[0..n]	

### 9.1.14 BICOrBEI <BICOrBEI>

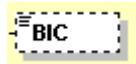

**Presence:** [0..1]

**Definition:** Code allocated to organisations by the ISO 9362 Registration Authority, under an international identification scheme, as described in the latest version of the standard ISO 9362 Banking (Banking telecommunication messages, Bank Identifier Codes).

**Data Type:** AnyBICIdentifier

**Format:** [A-Z] {6,6}[A-Z2-9][A-NP-Z0-9]([A-Z0-9]{3,3}){0-1}

**Rule(s):** AnyBIC

Only a valid BIC or BEI is allowed. Valid BEI and BIC are registered with the ISO 9362 Registration Authority, and consists of eight (8) or eleven (11) contiguous characters comprising the first three or all four of the following components: BANK CODE, COUNTRY CODE, LOCATION CODE, BRANCH CODE. The bank code, country code and location code are mandatory, while the branch code is optional.

### 9.1.15 Other <Othr>

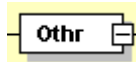

**Presence:** [0..n]

**Definition:** Unique identification of an organisation, as assigned by an institution, using an identification scheme.

**Type:** *This message item is composed of the following GenericOrganisationIdentification1 element(s):*

Ref	Or	Message Item	<XML Tag>	Mult.	Represent./ Type
<a href="#">9.1.16</a>		Identification	<Id>	[1..1]	Text

### 9.1.16 Identification <Id>

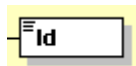

**Presence:** [1..1]

**Definition:** Identification assigned by an institution.

**Data Type:** Max35Text

**Format:** maxLength: 35  
minLength: 1

## 2.204 Creditor <Cdtr>

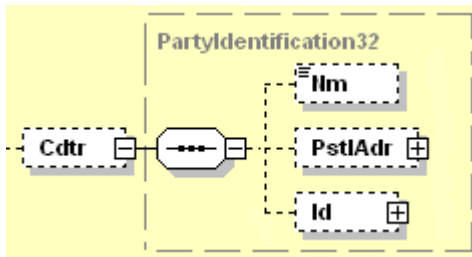

**Presence:** [0..1]

**Definition:** Party to which an amount of money is due.

**Type:** *This message item is composed of the following **PartyIdentification32** element(s):*

Ref	Or	Message Item	<XML Tag>	Mult.	Represent./ Type
<a href="#">9.1.0</a>		Name	<Nm>	[0..1]	Text
<a href="#">9.1.1</a>		PostalAddress	<PstlAdr>	[0..1]	
<a href="#">9.1.12</a>		Identification	<Id>	[0..1]	

### 9.1.0 Name <Nm>



**Presence:** [0..1]

**Definition:** Name by which a party is known and which is usually used to identify that party.

**Data Type:** Max140Text

**Format:** maxLength: 140  
minLength: 1

### 9.1.1 PostalAddress <PstIAdr>

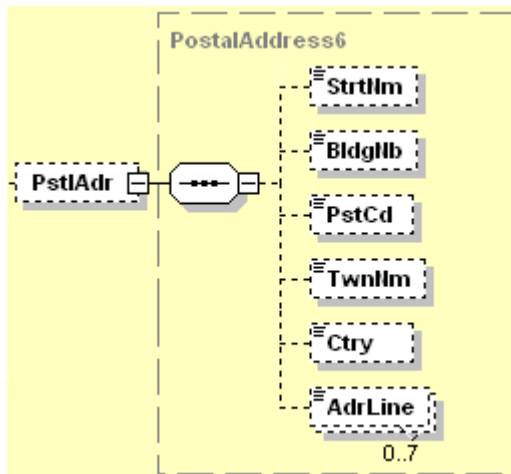

**Presence:** [0..1]

**Definition:** Information that locates and identifies a specific address, as defined by postal services.

**Type:** *This message item is composed of the following **PostalAddress6** element(s):*

Ref	Or	Message Item	<XML Tag>	Mult.	Represent./ Type
<a href="#">9.1.5</a>		StreetName	<StrtNm>	[0..1]	Text
<a href="#">9.1.6</a>		BuildingNumber	<BldgNb>	[0..1]	Text
<a href="#">9.1.7</a>		PostCode	<PstCd>	[0..1]	Text
<a href="#">9.1.8</a>		TownName	<TwnNm>	[0..1]	Text
<a href="#">9.1.10</a>		Country	<Ctry>	[0..1]	Code
<a href="#">9.1.11</a>		AddressLine	<AdrLine>	[0..7]	Text

### 9.1.5 StreetName <StrtNm>

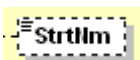

**Presence:** [0..1]

**Definition:** Name of a street or thoroughfare.

**Data Type:** Max70Text

**Format:** maxLength: 70  
minLength: 1

### 9.1.6 BuildingNumber <BldgNb>



**Presence:** [0..1]  
**Definition:** Number that identifies the position of a building on a street.  
**Data Type:** Max16Text  
**Format:** maxLength: 16  
minLength: 1

### 9.1.7 PostCode <PstCd>

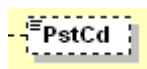

**Presence:** [0..1]  
**Definition:** Identifier consisting of a group of letters and/or numbers that is added to a postal address to assist the sorting of mail.  
**Data Type:** Max16Text  
**Format:** maxLength: 16  
minLength: 1

### 9.1.8 TownName <TwnNm>



**Presence:** [0..1]  
**Definition:** Name of a built-up area, with defined boundaries, and a local government.  
**Data Type:** Max35Text  
**Format:** maxLength: 35  
minLength: 1



### 9.1.10 Country <Ctry>

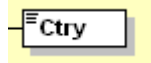

<b>Presence:</b>	[0..1]
<b>Definition:</b>	Nation with its own government.
<b>Data Type:</b>	CountryCode
<b>Format:</b>	[A-Z]{2,2}
<b>Rule(s):</b>	Country

The code is checked against the list of country names obtained from the United Nations (ISO 3166, Alpha-2 code).

### 9.1.11 AddressLine <AdrLine>

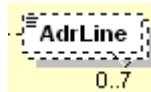

<b>Presence:</b>	[0..7]
<b>Definition:</b>	Information that locates and identifies a specific address, as defined by postal services, presented in free format text.
<b>Data Type:</b>	Max70Text
<b>Format:</b>	maxLength: 70 minLength: 1

### 9.1.12 Identification <Id>

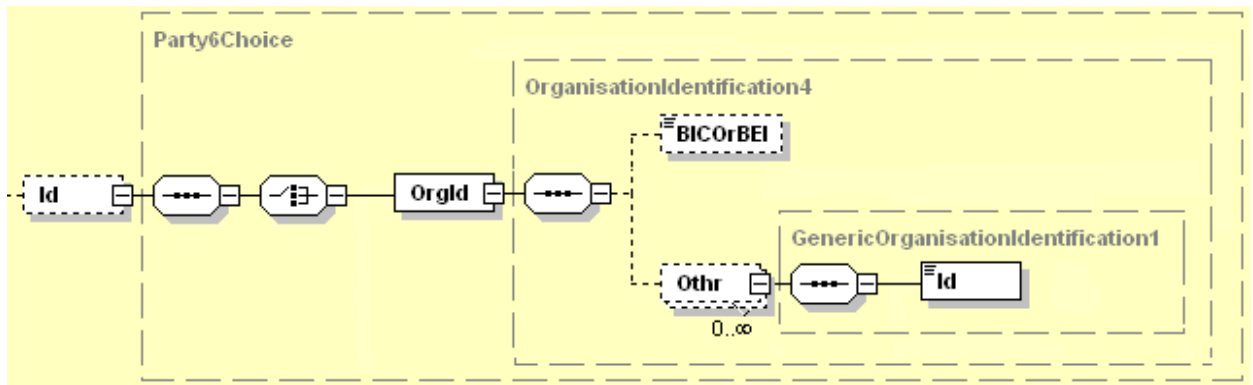

**Presence:** [0..1]

**Definition:** Unique and unambiguous identification of a party.

**Type:** *This message item is composed of one of the following **Party6Choice** element(s):*

<a href="#">9.1.13</a>		OrganisationIdentification	<OrgId>	[1..1]	
<a href="#">9.1.14</a>		BICOrBEI	<BICOrBEI>	[0..1]	Identifier
<a href="#">9.1.15</a>		Other	<Othr>	[0..n]	
<a href="#">9.1.16</a>		Identification	<Id>	[1..1]	Text

### 9.1.13 OrganisationIdentification <OrgId>



**Presence:** [1..1]

*This message item is part of choice **9.1.12 Identification**.*

**Definition:** Unique and unambiguous way to identify an organisation.

**Type:** *This message item is composed of the following **OrganisationIdentification4** element(s):*

### 9.1.14 BICOrBEI <BICOrBEI>

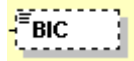

**Presence:** [0..1]

**Definition:** Code allocated to organisations by the ISO 9362 Registration Authority, under an international identification scheme, as described in the latest version of the standard ISO 9362 Banking (Banking telecommunication messages, Bank Identifier Codes).

The Ba

**Data Type:** AnyBICIdentifier

**Format:** [A-Z]{6,6}[A-Z2-9][A-NP-Z0-9]([A-Z0-9]{3,3}){0,1}

**Rule(s):** AnyBIC

Only a valid BIC or BEI is allowed. Valid BEI and BIC are registered with the ISO 9362 Registration Authority, and consists of eight (8) or eleven (11) contiguous characters comprising the first three or all four of the following components: BANK CODE, COUNTRY CODE, LOCATION CODE, BRANCH CODE. The bank code, country code and location code are mandatory, while the branch code is optional.

(Fatal) Error Code: Sw.Stds.D00008

### 9.1.15 Other <Othr>

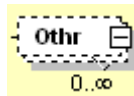

**Presence:** [0..n]

**Definition:** Unique identification of an organisation, as assigned by an institution, using an identification scheme.

### 9.1.16 Identification <Id>

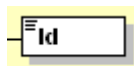

**Presence:** [1..1]

**Definition:** Identification assigned by an institution.

**Data Type:** Max35Text

**Format:** maxLength: 35  
minLength: 1

## 2.205 CreditorAccount <CdtrAcct>

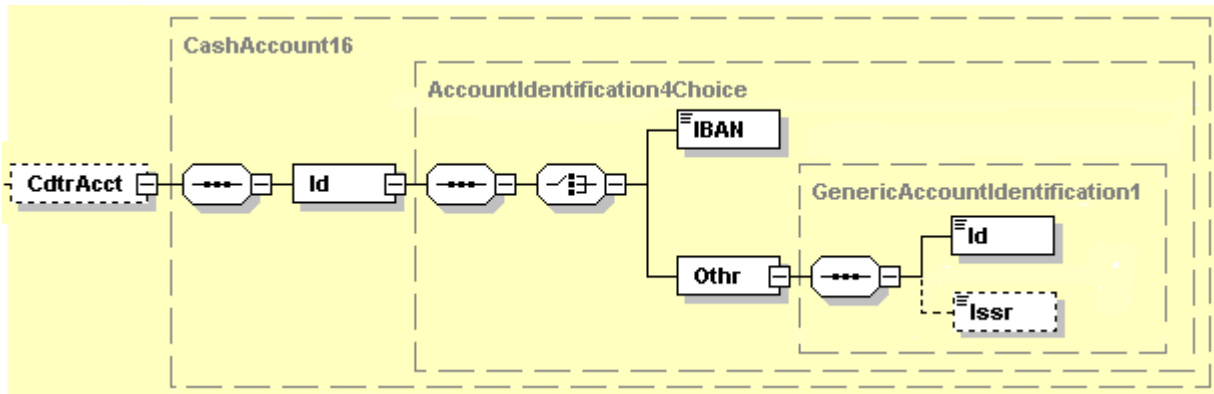

**Presence:** [0..1]

**Definition:** Identifies the parent account of the account for which the statement has been issued.

**Type:** *This message item is composed of the following **CashAccount16** element(s):*

Ref	Or	Message Item	<XML Tag>	Mult.	Represent./ Type
<u>1.1.0</u>		Identification	<Id>	[1..1]	
<u>1.1.1</u>	{Or	IBAN	<IBAN>	[1..1]	Identifier
<u>1.1.2</u>	Or}	Other	<Othr>	[1..1]	
<u>1.1.3</u>		Identification	<Id>	[1..1]	Text
<u>1.1.7</u>		Issuer	<Issr>	[0..1]	Text

### 1.1.0 Identification <Id>

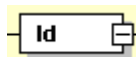

**Presence:** [1..1]

**Definition:** Unique and unambiguous identification for the account between the account owner and the account servicer.

**Type:** *This message item is composed of the following **AccountIdentification4Choice** element:*

Ref	Or	Message Item	<XML Tag>	Mult.	Represent./ Type
<u>1.1.1</u>		IBAN	<IBAN>	[1..1]	Identifier

### 1.1.1 IBAN <IBAN>



**Presence:** [1..1]

*This message item is part of choice 1.1.0 Identification.*

**Definition:** International Bank Account Number (IBAN) - identifier used internationally by financial institutions to uniquely identify the account of a customer. Further specifications of the format and content of the IBAN can be found in the standard ISO 13616 "Banking and related financial services - International Bank Account Number (IBAN)" version 1997-10-01, or later revisions.

**Data Type:** IBAN2007Identifier

**Format:** [A-Z]{2,2}[0-9]{2,2}[a-zA-Z0-9]{1,30}

**Rule(s):** IBAN

A valid IBAN consists of all three of the following components: Country Code, check digits and BBAN.

(Fatal) Error Code: Sw.Stds.D00003

### 1.1.2 Other <Othr>

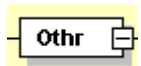

**Presence:** [1..1]

*This message item is part of choice 1.1.0 Identification.*

**Definition:** Unique identification of an account, as assigned by the account servicer, using an identification scheme.

**Type:** *This message item is composed of the following GenericAccountIdentification1 element(s):*

### 1.1.3 Identification <Id>



**Presence:** [1..1]

**Definition:** Identification assigned by an institution.

**Data Type:** Max34Text

**Format:** maxLength: 34  
minLength: 1

### 1.1.7 Issuer <Issr>

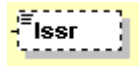

**Presence:** [0..1]  
**Definition:** Entity that assigns the identification.  
**Data Type:** Max35Text  
**Format:** maxLength: 35  
 minLength: 1

### 2.206 UltimateCreditor <UltmtCdtr>

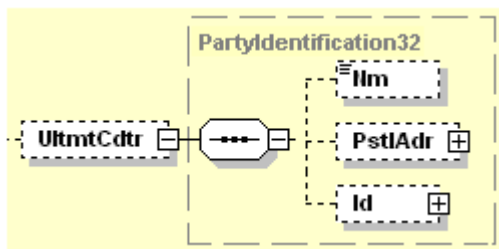

**Presence:** [0..1]  
**Definition:** Ultimate party to which an amount of money is due.  
**Type:** *This message item is composed of the following PartyIdentification32 element(s):*

Ref	Or	Message Item	<XML Tag>	Mult.	Represent./ Type
<a href="#">9.1.0</a>		Name	<Nm>	[0..1]	Text
<a href="#">9.1.1</a>		PostalAddress	<PstlAdr>	[0..1]	
<a href="#">9.1.12</a>		Identification	<Id>	[0..1]	

### 9.1.0 Name <Nm>



**Presence:** [0..1]  
**Definition:** Name by which a party is known and which is usually used to identify that party.  
**Data Type:** Max140Text  
**Format:** maxLength: 140  
 minLength: 1

### 9.1.1 PostalAddress <PstIAdr>

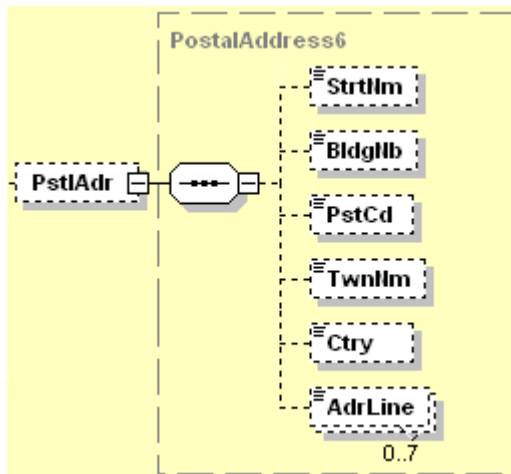

**Presence:** [0..1]

**Definition:** Information that locates and identifies a specific address, as defined by postal services.

**Type:** *This message item is composed of the following **PostalAddress6** element(s):*

Ref	Or	Message Item	<XML Tag>	Mult.	Represent./ Type
<a href="#">9.1.5</a>		StreetName	<StrtNm>	[0..1]	Text
<a href="#">9.1.6</a>		BuildingNumber	<BldgNb>	[0..1]	Text
<a href="#">9.1.7</a>		PostCode	<PstCd>	[0..1]	Text
<a href="#">9.1.8</a>		TownName	<TwnNm>	[0..1]	Text
<a href="#">9.1.10</a>		Country	<Ctry>	[0..1]	Code
<a href="#">9.1.11</a>		AddressLine	<AdrLine>	[0..7]	Text

### 9.1.5 StreetName <StrtNm>

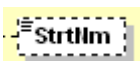

**Presence:** [0..1]

**Definition:** Name of a street or thoroughfare.

**Data Type:** Max70Text

**Format:** maxLength: 70  
minLength: 1

### 9.1.6 BuildingNumber <BldgNb>



<b>Presence:</b>	[0..1]
<b>Definition:</b>	Number that identifies the position of a building on a street.
<b>Data Type:</b>	Max16Text
<b>Format:</b>	maxLength: 16 minLength: 1

### 9.1.7 PostCode <PstCd>

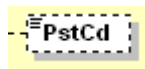

<b>Presence:</b>	[0..1]
<b>Definition:</b>	Identifier consisting of a group of letters and/or numbers that is added to a postal address to assist the sorting of mail.
<b>Data Type:</b>	Max16Text
<b>Format:</b>	maxLength: 16 minLength: 1

### 9.1.8 TownName <TwnNm>



<b>Presence:</b>	[0..1]
<b>Definition:</b>	Name of a built-up area, with defined boundaries, and a local government.
<b>Data Type:</b>	Max35Text
<b>Format:</b>	maxLength: 35 minLength: 1

### 9.1.10 Country <Ctry>

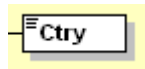

<b>Presence:</b>	[0..1]
<b>Definition:</b>	Nation with its own government.
<b>Data Type:</b>	CountryCode
<b>Format:</b>	[A-Z]{2,2}
<b>Rule(s):</b>	Country

The code is checked against the list of country names obtained from the United Nations (ISO 3166, Alpha-2 code).



### 9.1.11 AddressLine <AdrLine>

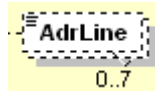

**Presence:** [0..7]

**Definition:** Information that locates and identifies a specific address, as defined by postal services, presented in free format text.

**Data Type:** Max70Text

**Format:** maxLength: 70  
minLength: 1

### 9.1.12 Identification <Id>



**Presence:** [0..1]

**Definition:** Unique and unambiguous identification of a party

**Type:** *This message item is composed of one of the following Party6Choice element(s):*

Ref	Or	Message Item	<XML Tag>	Mult.	Represent./ Type
<a href="#">9.1.13</a>		OrganisationIdentification	<OrgId>	[1..1]	

### 9.1.13 OrganisationIdentification <OrgId>



**Presence:** [1..1]

*This message item is part of choice 9.1.12 Identification.*

**Definition:** Unique and unambiguous way to identify an organisation

**Type:** *This message item is composed of the following OrganisationIdentification4 element(s):*

Ref	Or	Message Item	<XML Tag>	Mult.	Represent./ Type
<a href="#">9.1.14</a>		BICOrBEI	<BICOrBEI>	[0..1]	Identifier
<a href="#">9.1.15</a>		Other	<Othr>	[0..n]	

### 9.1.14 BICOrBEI <BICOrBEI>

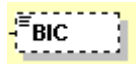

**Presence:** [0..1]

**Definition:** Code allocated to organisations by the ISO 9362 Registration Authority, under an international identification scheme, as described in the latest version of the standard ISO 9362 Banking (Banking telecommunication messages, Bank Identifier Codes).

**Data Type:** AnyBICIdentifier

**Format:** [A-Z] {6,6}[A-Z2-9][A-NP-Z0-9]([A-Z0-9]{3,3}){0-1}

**Rule(s):** AnyBIC

Only a valid BIC or BEI is allowed. Valid BEI and BIC are registered with the ISO 9362 Registration Authority, and consists of eight (8) or eleven (11) contiguous characters comprising the first three or all four of the following components: BANK CODE, COUNTRY CODE, LOCATION CODE, BRANCH CODE. The bank code, country code and location code are mandatory, while the branch code is optional.

### 9.1.15 Other <Othr>

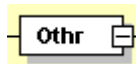

**Presence:** [0..n]

**Definition:** Unique identification of an organisation, as assigned by an institution, using an identification scheme.

**Type:** *This message item is composed of the following GenericOrganisationIdentification1 element(s):*

Ref	Or	Message Item	<XML Tag>	Mult.	Represent./ Type
<a href="#">9.1.16</a>		Identification	<Id>	[1..1]	Text

### 9.1.16 Identification <Id>

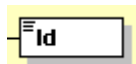

**Presence:** [1..1]

**Definition:** Identification assigned by an institution.

**Data Type:** Max35Text

**Format:** maxLength: 35  
minLength: 1

## 2.211 RelatedAgents <RltdAgts>

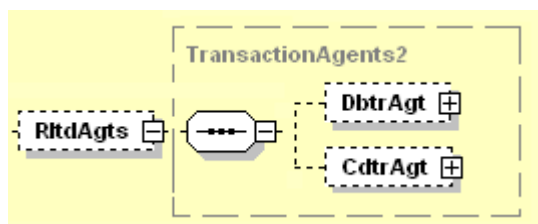

**Presence:** [0..1]

**Definition:** Set of elements used to identify the agents related to the underlying transaction.

**Type:** *This message item is composed of the following TransactionAgents2 element(s):*

Index	Or	Message Item	<XML Tag>	Mult.	Represent./ Type
<a href="#">2.212</a>		DebtorAgent	<DbtrAgt>	[0..1]	±
<a href="#">2.213</a>		CreditorAgent	<CdtrAgt>	[0..1]	±

## 2.212 DebtorAgent <DbtrAgt>

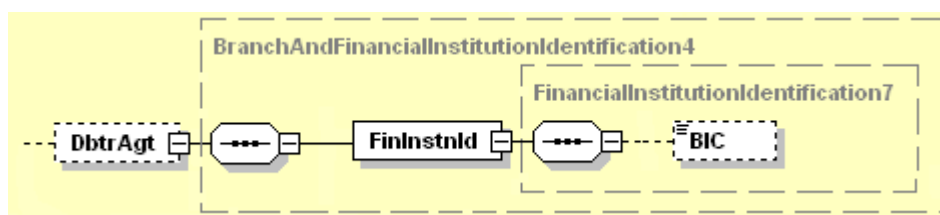

**Presence:** [0..1]

**Definition:** Financial institution servicing an account for the debtor.

**Type:** *This message item is composed of the following BranchAndFinancialInstitutionIdentification4 element(s):*

Ref	Or	Message Item	<XML Tag>	Mult.	Represent./ Type
<a href="#">6.1.0</a>		FinancialInstitutionIdentification	<FinInstnId>	[1..1]	
<a href="#">6.1.1</a>		BIC	<BIC>	[0..1]	Identifier

*For additional Type information, please refer to BranchAndFinancialInstitutionIdentification4 in 'Message Item Types' section.*

## 6.1.0 FinancialInstitutionIdentification <FinInstnId>



**Presence:** [1..1]

**Definition:** Unique and unambiguous identification of a financial institution, as assigned under an internationally recognised or proprietary identification scheme.

**Type:** *This message item is composed of the following **FinancialInstitutionIdentification** element*

## 6.1.1 BIC <BIC>

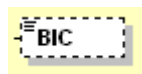

**Presence:** [0..1]

**Definition:** Bank Identifier Code. Code allocated to financial institutions by the Registration Authority, under an international identification scheme, as described in the latest version of the standard ISO 9362 Banking (Banking telecommunication messages, Bank Identifier Codes).

**Data Type:** BICIdentifier

**Format:** [A-Z]{6,6}[A-Z2-9][A-NP-Z0-9]([A-Z0-9]{3,3}){0,1}

**Rule(s):** BIC

Valid BICs are registered with the ISO 9362 Registration Authority, and consist of eight (8) or eleven (11) contiguous characters comprising the first three or all four of the following components: BANK CODE, COUNTRY CODE, LOCATION CODE, BRANCH CODE. The bank code, country code and location code are mandatory, while the branch code is optional.

(Fatal) Error Code: Sw.Stds.D00001

## 2.213 CreditorAgent <CdtrAgt>

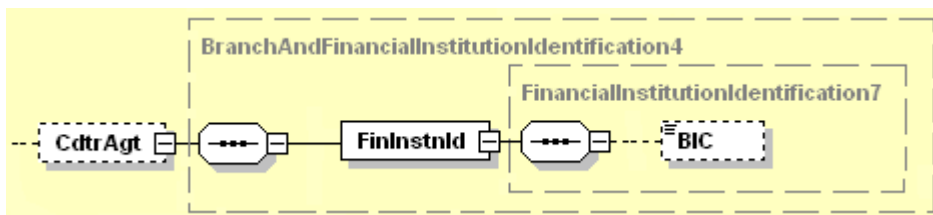

**Presence:** [0..1]

**Definition:** Financial institution servicing an account for the creditor.

**Type:** *This message item is composed of the following **BranchAndFinancialInstitutionIdentification4** element(s):*

Ref	Or	Message Item	<XML Tag>	Mult.	Represent./ Type
<a href="#">6.1.0</a>		FinancialInstitutionIdentification	<FinInstnId>	[1..1]	
<a href="#">6.1.1</a>		BIC	<BIC>	[0..1]	Identifier

*For additional Type information, please refer to **BranchAndFinancialInstitutionIdentification4** in 'Message Item Types' section.*

### 6.1.0 FinancialInstitutionIdentification <FinInstnId>



**Presence:** [1..1]

**Definition:** Unique and unambiguous identification of a financial institution, as assigned under an internationally recognised or proprietary identification scheme.

**Type:** *This message item is composed of the following **FinancialInstitutionIdentification** element*

### 6.1.1 BIC <BIC>

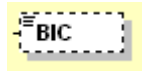

**Presence:** [0..1]

**Definition:** Bank Identifier Code. Code allocated to financial institutions by the Registration Authority, under an international identification scheme, as described in the latest version of the standard ISO 9362 Banking (Banking telecommunication messages, Bank Identifier Codes).

**Data Type:** BICIdentifier

**Format:** [A-Z]{6,6}[A-Z2-9][A-NP-Z0-9]([A-Z0-9]{3,3}){0,1}

**Rule(s):** BIC

Valid BICs are registered with the ISO 9362 Registration Authority, and consist of eight (8) or eleven (11) contiguous characters comprising the first three or all four of the following components: BANK CODE COUNTRY CODE, LOCATION CODE, BRANCH CODE. The bank code, country code and location code are mandatory, while the branch code is optional.

(Fatal) Error Code: Sw.Stds.D00001

### 2.224 Purpose <Purp>

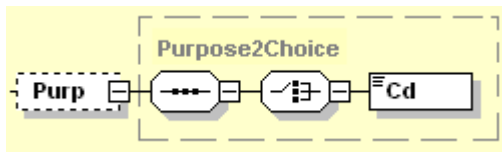

**Presence:** [0..1]

**Definition:** Underlying reason for the payment transaction.

**Usage:** Purpose is used by the end-customers, that is initiating party, (ultimate) debtor, (ultimate) creditor to provide information concerning the nature of the payment. Purpose is a content element, which is not used for processing by any of the agents involved in the payment chain.

**Type:** *This message item is composed of the following Purpose2Choice element:*

Index	Or	Message Item	<XML Tag>	Mult.	Represent./ Type
<u>2.225</u>		Code	<Cd>	[1..1]	Code

## 2.225 Code <Cd>

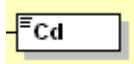

**Presence:** [1..1]

*This message item is part of choice 2.224 Purpose.*

**Definition:** Underlying reason for the payment transaction, as published in an external purpose code list.

**Data Type:** ExternalPurpose1Code

**Format:** maxLength: 4  
minLength: 1

[Purpose code list](#) (To select thumbnail 9)

## 2.234 RemittanceInformation <RmtInf>

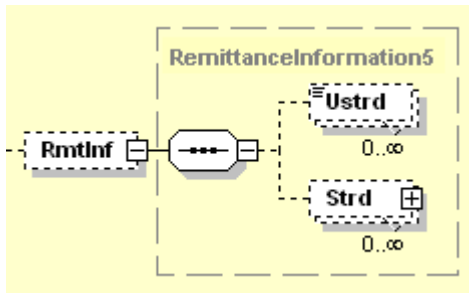

**Presence:** [0..1]

**Definition:** Structured information that enables the matching, ie, reconciliation, of a payment with the items that the payment is intended to settle, such as commercial invoices in an account receivable system.

**Type:** *This message item is composed of the following **RemittanceInformation5** element(s):*

Index	Or	Message Item	<XML Tag>	Mult.	Represent./ Type
<a href="#">2.235</a>		Unstructured	<Ustrd>	[0..n]	Text
<a href="#">2.236</a>		Structured	<Strd>	[0..n]	

## 2.235 Unstructured <Ustrd>



**Presence:** [0..n]

**Definition:** Information supplied to enable the matching/reconciliation of an entry with the items that the payment is intended to settle, such as commercial invoices in an accounts' receivable system, in an unstructured form.

**Data Type:** Max140Text

**Format:** maxLength: 140  
minLength: 1

## 2.236 Structured <Strd>

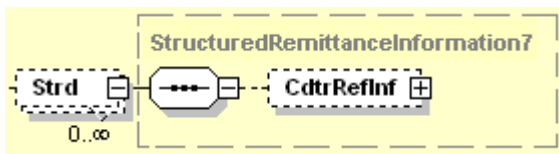

**Presence:** [0..n]

**Definition:** Information supplied to enable the matching/reconciliation of an entry with the items that the payment is intended to settle, such as commercial invoices in an accounts' receivable system, in a structured form.

**Type:** *This message item is composed of the following StructuredRemittanceInformation7 element(s):*

**BBA USAGE:** see 4.2 – Reporting of Structured Creditor references to RemittanceInformation – 2.234 item

Index	Or	Message Item	<XML Tag>	Mult.	Represent./ Type
<a href="#">2.256</a>		CreditorReferenceInformation	<CdtRefInf>	[0..1]	



## 2.256 CreditorReferenceInformation <CdtrRefInf>

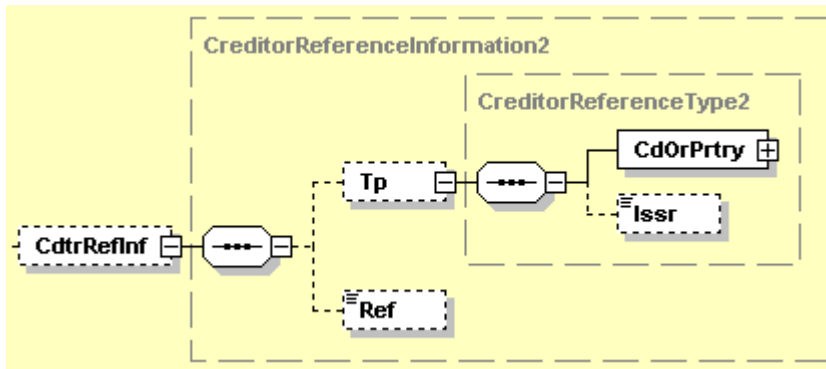

**Presence:** [0..1]

**Definition:** Reference information provided by the creditor to allow the identification of the underlying documents.

**Type:** *This message item is composed of the following **CreditorReferenceInformation2** element(s):*

Index	Or	Message Item	<XML Tag>	Mult.	Represent./ Type
<a href="#">2.257</a>		Type	<Tp>	[0..1]	
<a href="#">2.262</a>		Reference	<Ref>	[0..1]	Text

## 2.257 Type <Tp>

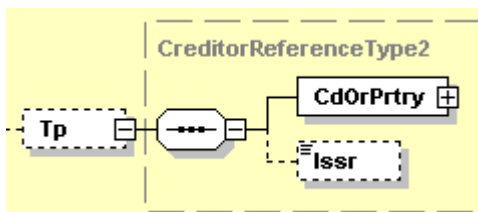

**Presence:** [0..1]

**Definition:** Specifies the type of creditor reference.

**Type:** *This message item is composed of the following **CreditorReferenceType2** element(s):*

Index	Or	Message Item	<XML Tag>	Mult.	Represent./ Type
<a href="#">2.258</a>		CodeOrProprietary	<CdOrPrtry>	[1..1]	
<a href="#">2.261</a>		Issuer	<Issr>	[0..1]	Text

## 2.258 CodeOrProprietary <CdOrPrtry>

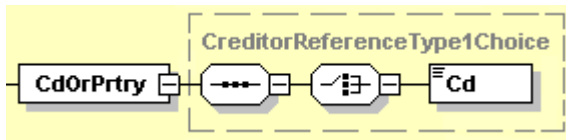

**Presence:** [1..1]

**Definition:** Coded or proprietary format creditor reference type.

**Type:** *This message item is composed of the following **CreditorReferenceType1Choice** element:*

Index	Or	Message Item	<XML Tag>	Mult.	Represent./ Type
2.259		Code	<Cd>	[1..1]	Code

## 2.259 <Cd>

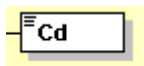

**Presence:** [1..1]

*This message item is part of choice 8.3.23 CodeOrProprietary.*

**Definition:** Type of creditor reference, in a coded form.

**Data Type:** Code

*One of the following **DocumentType3Code** values must be used:*

Code	Name	Definition
SCOR	StructuredCommunicationReference	Document is a structured communication reference provided by the creditor to identify the referred transaction.

## 2.261 Issuer <Issr>

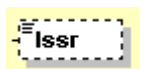

**Presence:** [0..1]

**Definition:** Entity that assigns the credit reference type.

**Data Type:** Max35Text

**Format:** maxLength: 35  
minLength: 1

## 2.262 Reference <Ref>

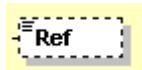

**Presence:** [0..1]

**Definition:** Unique reference, as assigned by the creditor, to unambiguously refer to the payment transaction.

**Usage:** If available, the initiating party should provide this reference in the structured remittance information, to enable reconciliation by the creditor upon receipt of the amount of money.

If the business context requires the use of a creditor reference or a payment remit identification, and only one identifier can be passed through the end-to-end chain, the creditor's reference or payment remittance identification should be quoted in the end-to-end transaction identification.

**Data Type:** Max35Text

**Format:** maxLength: 35  
minLength: 1

## 2.266 RelatedDates <RltdDts>

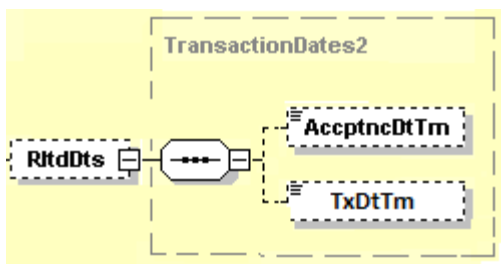

**Presence:** [0..1]

**Definition:** Set of elements identifying the dates related to the underlying transactions.

**Type:** *This message item is composed of the following TransactionDates2 element(s):*

Index	Or	Message Item	<XML Tag>	Mult.	Represent./ Type
<a href="#">2.267</a>		AcceptanceDateTime	<AcptncDtTm>	[0..1]	DateTime
<a href="#">2.273</a>		TransactionDateTime	<TxDtTm>	[0..1]	DateTime

## 2.267 AcceptanceDateTime <AcptncDtTm>



**Presence:** [0..1]

**Definition:** Point in time when the payment order from the initiating party meets the processing conditions of the account servicing agent. This means that the account servicing agent has received the payment order and has applied checks such as authorisation, availability of funds.

**Data Type:** ISODateTime

## 2.273 TransactionDateTime <TxDtTm>

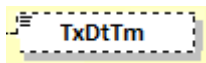

**Presence:** [0..1]

**Definition:** Date and time of the underlying transaction.

**Data Type:** ISODateTime

## 2.292 Tax <Tax>

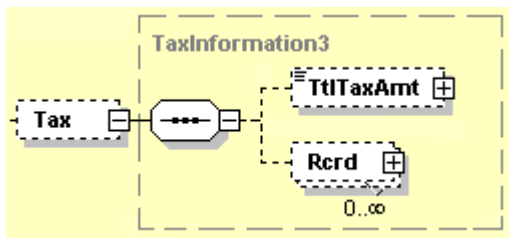

**Presence:** [0..1]

**Definition:** Set of elements used to provide details on the tax.

**Type:** *This message item is composed of the following **TaxInformation3** element(s):*

Ref	Or	Message Item	<XML Tag>	Mult.	Represent./ Type
<a href="#">13.1.15</a>		TotalTaxAmount	<TtlTaxAmt>	[0..1]	Amount
<a href="#">13.1.18</a>		Record	<Rcrd>	[0..n]	

### 13.1.15 TotalTaxAmount <TtlTaxAmt>

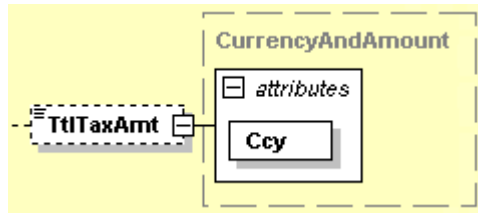

**Presence:** [0..1]

**Definition:** Total amount of money as result of the calculation of the tax.

**Data Type:** ActiveOrHistoricCurrencyAndAmount

*This data type must be used with the following XML Attribute: **Currency (Ccy)** which is typed by*

*ActiveOrHistoricCurrencyCode.*

**Format:** ActiveOrHistoricCurrencyAndAmount

fractionDigits: 5

minInclusive: 0

totalDigits: 18

**ActiveOrHistoricCurrencyCode**

[A-Z]{3,3}

**Rule(s):** ActiveOrHistoricCurrencyAndAmount

CurrencyAmount

The number of fractional digits (or minor unit of currency) must comply with ISO 4217.

Note: The decimal separator is a dot.

(Fatal) Error Code: Sw.Stds.D00007

**ActiveOrHistoricCurrencyCode**

ActiveOrHistoricCurrency

The Currency Code must be registered, or have already been registered. Valid active or historic currency codes are registered with the ISO 4217 Maintenance Agency, consist of three (3) contiguous letters, and may be or not be withdrawn on the day the message containing the Currency is exchanged.

(Fatal) Error Code: Sw.Stds.D00006

**BBA USAGE:** see 4.4 - Reporting of costs, fees and taxes

### 13.1.18 Record <Rcrd>

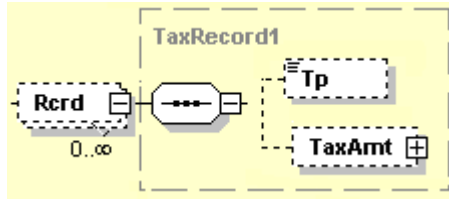

**Presence:** [0..n]

**Definition:** Record of tax details.

**Type:** *This message item is composed of the following **TaxRecord1** element(s):*

Ref	Or	Message Item	<XML Tag>	Mult.	Represent./ Type
<a href="#">13.1.19</a>		Type	<Tp>	[0..1]	Text
<a href="#">13.1.31</a>		TaxAmount	<TaxAmt>	[0..1]	

### 13.1.19 Type <Tp>



**Presence:** [0..1]

**Definition:** High level code to identify the type of tax details.

**Data Type:** Max35Text

**Format:** maxLength: 35  
minLength: 1

**BBA USAGE:** Use the category code (see 6.2 – Category)

### 13.1.31 TaxAmount <TaxAmt>

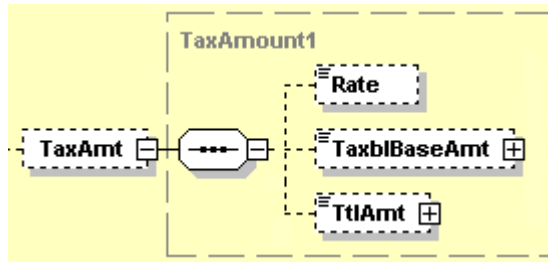

**Presence:** [0..1]

**Definition:** Set of elements used to provide information on the amount of the tax record.

**Type:** *This message item is composed of the following **TaxAmount1** element(s):*

Ref	Or	Message Item	<XML Tag>	Mult.	Represent./ Type
<a href="#">13.1.32</a>		Rate	<Rate>	[0..1]	Rate
<a href="#">13.1.33</a>		TaxableBaseAmount	<TaxblBaseAmt>	[0..1]	Amount
<a href="#">13.1.34</a>		TotalAmount	<TtlAmt>	[0..1]	Amount

### 13.1.32 Rate <Rate>



**Presence:** [0..1]

**Definition:** Rate used to calculate the tax.

**Data Type:** PercentageRate

**Format:** fractionDigits: 10  
totalDigits: 11

### 13.1.33 TaxableBaseAmount <TaxblBaseAmt>

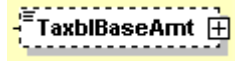

**Presence:** [0..1]

**Definition:** Amount of money on which the tax is based.

**Data Type:** ActiveOrHistoricCurrencyAndAmount

*This data type must be used with the following XML Attribute: **Currency (Ccy)** which is typed by **ActiveOrHistoricCurrencyCode**.*

**Format:** **ActiveOrHistoricCurrencyAndAmount**

fractionDigits: 5

minInclusive: 0

totalDigits: 18

**ActiveOrHistoricCurrencyCode**

[A-Z]{3,3}

**Rule(s):** **ActiveOrHistoricCurrencyAndAmount**

CurrencyAmount

The number of fractional digits (or minor unit of currency) must comply with ISO 4217.

Note: The decimal separator is a dot. (Fatal) Error Code: Sw.Stds.D00007

**ActiveOrHistoricCurrencyCode**

ActiveOrHistoricCurrency

The Currency Code must be registered, or have already been registered. Valid active or historic currency codes are registered with the ISO 4217 Maintenance Agency, consist of three (3) contiguous letters, and may be or not be withdrawn on the day the message containing the Currency is exchanged.

(Fatal) Error Code: Sw.Stds.D00006



### 13.1.34 TotalAmount <TtlAmt>



**Presence:** [0..1]

**Definition:** Total amount that is the result of the calculation of the tax for the record.

**Data Type:** ActiveOrHistoricCurrencyAndAmount

*This data type must be used with the following XML Attribute: **Currency (Ccy)** which is typed by **ActiveOrHistoricCurrencyCode**.*

**Format:** **ActiveOrHistoricCurrencyAndAmount**

fractionDigits: 5

minInclusive: 0

totalDigits: 18

**ActiveOrHistoricCurrencyCode**

[A-Z]{3,3}

**Rule(s):** **ActiveOrHistoricCurrencyAndAmount**

CurrencyAmount

The number of fractional digits (or minor unit of currency) must comply with ISO 4217.

Note: The decimal separator is a dot.

(Fatal) Error Code: Sw.Stds.D00007

**ActiveOrHistoricCurrencyCode**

ActiveOrHistoricCurrency

The Currency Code must be registered, or have already been registered. Valid active or historic currency codes are registered with the ISO 4217 Maintenance Agency, consist of three (3) contiguous letters, and may be or not be withdrawn on the day the message containing the Currency is exchanged.

(Fatal) Error Code: Sw.Stds.D00006

## 2.293 ReturnInformation <RtrInf>

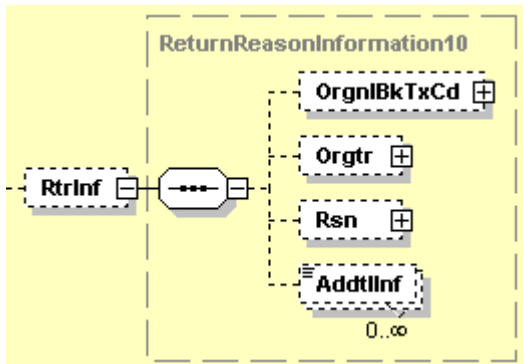

**Presence:** [0..1]

**Definition:** Set of elements used to provide the return information.

**Type:** *This message item is composed of the following **ReturnReasonInformation10** element(s):*

**Rule(s):** ReturnReasonRule

If Reason/Code is equal to NARR, then AdditionalInformation must be present.

(Fatal) Error Code: Sw.Stds.X00077

Index	Or	Message Item	<XML Tag>	Mult.	Represent./ Type
<a href="#">2.294</a>		OriginalBankTransactionCode	<OrgnlBkTxCd>	[0..1]	
<a href="#">2.303</a>		Originator	<Orgtr>	[0..1]	±
<a href="#">2.304</a>		Reason	<Rsn>	[0..1]	
<a href="#">2.307</a>		AdditionalInformation	<AddtlInf>	[0..n]	Text

## 2.294 OriginalBankTransactionCode <OrgnlBkTxCd>

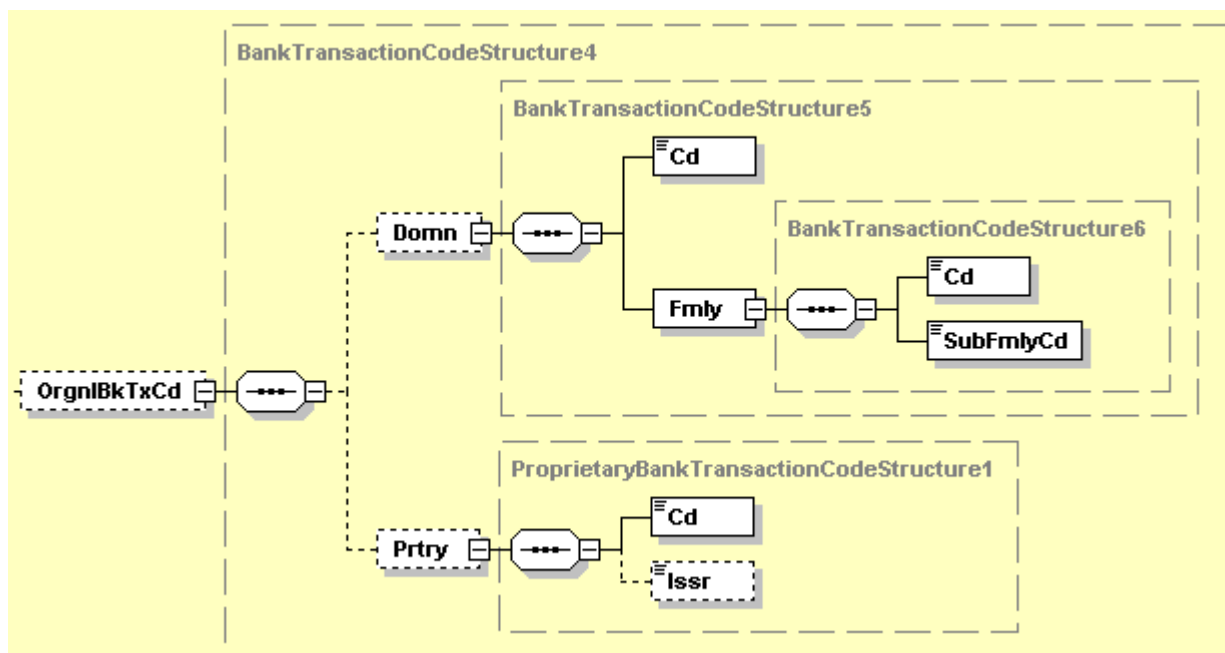

**Presence:** [0..1]

**Definition:** Set of elements to fully identify the type of underlying transaction resulting in an entry.

**Type:** *This message item is composed of the following **BankTransactionCodeStructure1** element(s):*

UNIFI (ISO 20022) - Bank-to-Customer Cash Management Standards April 2007

MX camt.053.001.01 BankToCustomerStatementV01 Page 176

Index	Or	Message Item	<XML Tag>	Mult.	Represent./ Type
<a href="#">2.295</a>		Domain	<Domn>	[0..1]	
<a href="#">2.300</a>		Proprietary	<Prtry>	[0..1]	

## 2.295 Domain <Domn>



**Presence:** [0..1], R2

**Definition:** Set of elements used to provide the domain, the family and the sub-family of the bank transaction code, in a structured and hierarchical format.

**Usage:** If a specific family or sub-family code cannot be provided, the generic family code defined for the domain or the generic sub-family code defined for the family should be provided.

**Type:** *This message item is composed of the following BankTransactionCodeStructure5 element(s):*

Index	Or	Message Item	<XML Tag>	Mult.	Represent./ Type
<a href="#">2.296</a>		Code	<Cd>	[1..1]	Code
<a href="#">2.297</a>		Family	<Fmly>	[1..1]	

## 2.296 Code <Cd>

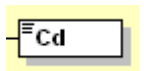

**Presence:** [1..1]

**Definition:** Specifies the business area of the underlying transaction.

**Data Type:** ExternalBankTransactionDomainCode

**Format:** maxLength: 4  
minLength: 1

## 2.297 Family <Fmly>

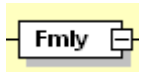

**Presence:** [1..1]

**Definition:** Specifies the family and the sub-family of the bank transaction code, within a specific domain, in a structured and hierarchical format.

**Type:** *This message item is composed of the following BankTransactionCodeStructure6 element(s):*

Index	Or	Message Item	<XML Tag>	Mult.	Represent./ Type
<a href="#">2.298</a>		Code	<Cd>	[1..1]	Code
<a href="#">2.299</a>		SubFamilyCode	<SubFmlyCd>	[1..1]	Code

## 2.298 Code <Cd>

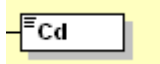

**Presence:** [1..1]  
**Definition:** Specifies the family within a domain.  
**Data Type:** ExternalBankTransactionFamilyCode  
**Format:** maxLength: 4  
 minLength: 1

## 2.299 SubFamilyCode <SubFmlyCd>



**Presence:** [1..1]  
**Definition:** Specifies the sub-product family within a specific family.  
**Data Type:** ExternalBankTransactionSubFamily1Code  
**Format:** maxLength: 4  
 minLength: 1

## 2.300 Proprietary <Prtry>

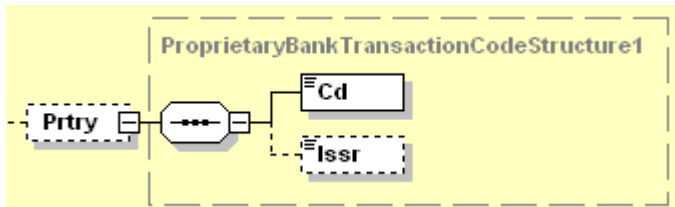

**Presence:** [0..1], R2  
**Definition:** Bank transaction code in a proprietary form, as defined by the issuer.  
**Type:** *This message item is composed of the following ProprietaryBankTransactionCodeStructure1 element(s):*  
**BBA USAGE:** The BBA Bank Transaction Code will be specified for each transaction (see 5.2)

Index	Or	Message Item	<XML Tag>	Mult.	Represent./ Type
<a href="#">2.301</a>		Code	<Cd>	[1..1]	Text
<a href="#">2.302</a>		Issuer	<Issr>	[0..1]	Text

### 2.301 Code <Cd>

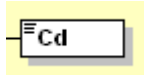

**Presence:** [1..1]  
**Definition:** Proprietary bank transaction code to identify the underlying transaction.  
**Data Type:** Max35Text  
**Format:** maxLength: 35  
 minLength: 1

### 2.302 Issuer <Issr>



**Presence:** [0..1]  
**Definition:** Identification of the issuer of the proprietary bank transaction code.  
**Data Type:** Max35Text  
**Format:** maxLength: 35  
 minLength: 1

### 2.303 Originator <Orgtr>

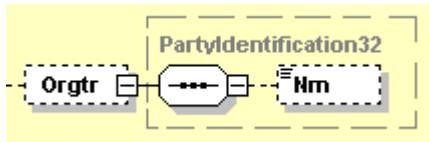

**Presence:** [0..1]  
**Definition:** Party that issues the return.  
**Type:** *This message item is composed of the following PartyIdentification32 element(s):*

Ref	Or	Message Item	<XML Tag>	Mult.	Represent./ Type
9.1.0		Name	<Nm>	[0..1]	Text

### 9.1.1.0 Name <Nm>

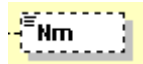

**Presence:** [0..1]

**Definition:** Name by which a party is known and which is usually used to identify that party.

**Data Type:** Max140Text

**Format:** maxLength: 140  
minLength: 1

### 2.304 Reason <Rsn>

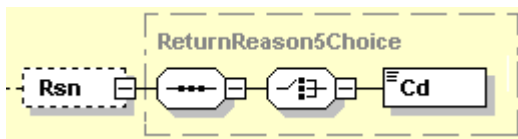

**Presence:** [0..1]

**Definition:** Specifies the reason for the return.

**Type:** *This message item is composed of one of the following ReturnReason5Choice element(s):*

Index	Or	Message Item	<XML Tag>	Mult.	Represent./ Type
<a href="#">2.305</a>		Code	<Cd>	[1..1]	Code

## 2.305 Code <Cd>

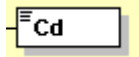

**Presence:** [1..1]

*This message item is part of choice 2.273 Reason.*

**Definition:** Reason for the return, as published in an external reason code list.

**Data Type:** ExternalReturnReason1Code

**Format:** maxLength: 4 minLength: 1

**BBA USAGE:** Only codes below are supported

Code	Name	Definition
AC01	IncorrectAccountNumber	Format of the account number specified is not correct.
AC04	ClosedAccountNumber	Account number specified has been closed on the Receiver's books.
AC06	BlockedAccount	Account specified is blocked, prohibiting posting of transactions against it.
AG01	TransactionForbidden	Transaction forbidden on this type of account (formerly NoAgreement).
AG02	InvalidBankOperationCode	Bank Operation code specified in the message is not valid for receiver.
AM05	Duplication	This message appears to have been duplicated.
BE01	InconsistentWithEndCustomer	Identification of end customer is not consistent with associated account number. (formerly CreditorConsistency)
MD01	NoMandate	Mandate is cancelled or invalid.
MD02	MissingMandatoryInformationInMandate	Mandate related information data required by the scheme is missing.
MD03	InvalidFileFormatForOtherReasonThanGroupingIndicator	File format incomplete or invalid.
MD06	RefundRequestByEndCustomer	Return of funds requested by end customer.
MD07	EndCustomerDeceased	End customer is deceased.
MS02	NotSpecifiedReasonCustomerGenerated	Reason has not been specified by end customer.
MS03	NotSpecifiedReasonAgentGenerated	Reason has not been specified by agent.
NARR	Narrative	Reason is provided as narrative information in the additional reason information.
RC01	BankIdentifierIncorrect	Bank identifier code specified in the message has an incorrect format (formerly IncorrectFormatForRoutingCode).



## 2.307 AdditionalInformation <AddtlInf>



<b>Presence:</b>	[0..n], R3
<b>Definition:</b>	Further details on the return reason.
<b>Data Type:</b>	Max105Text
<b>Format:</b>	maxLength: 105 minLength: 1

## 2.313 AdditionalTransactionInformation <AddtlTxInf>

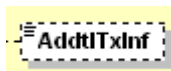

<b>Presence:</b>	[0..1]
<b>Definition:</b>	Further details of the transaction.
<b>Data Type:</b>	Max500Text
<b>Format:</b>	maxLength: 500 minLength: 1

## 2.314 AdditionalEntryInformation <AddtlNtryInf>



<b>Presence:</b>	[0..1]
<b>Definition:</b>	Further details of the entry.
<b>Data Type:</b>	Max500Text
<b>Format:</b>	maxLength: 500 minLength: 1

## 2.315 AdditionalStatementInformation <AddtlStmntInf>



<b>Presence:</b>	[0..1]
<b>Definition:</b>	Further details of the account statement.
<b>Data Type:</b>	Max500Text
<b>Format:</b>	maxLength: 500 minLength: 1

## 4. Principles governing the structure of reporting

In this chapter, we often make references to XML-examples in chapter 7.

The examples in chapter 7 are preceded by two indexes:

- A = Example-Index:  
This example-index is made to facilitate the reading of these guidelines. All items are numbered consecutively, in order to have unique references to the examples.
- B = MX.CAMT053.001.02-Index:  
This index represents the exact index numbering of the CAMT053.001.02.

### 4.1 General principles

#### 4.1.1. Information registered under the 'Entry' item – 2.76 :

- both for simple and globalised transactions, information can be retrieved from the following items :
  - Amount - 2.78 item : the net amount that has been booked
  - Creditdebitindicator – 2.79 item : the direction of the transaction
  - Reversalindicator – 2.80 item: the question whether one is dealing with a correction in writing or with R-transactions (SCT-SDD)
  - Status – 2.81 item : always 'booked' in the EoD reporting
  - BookingDate – 2.82 item : the booking date of the transaction
  - ValueDate – 2.83 item: the value date of the transaction
  - Accountservicereference – 2.84 item : the reference of the transaction generated by the bank
  - BankTransactionCode – 2.91 item : the transaction type
- If the charges are linked to a globalised transaction, information also can be retrieved from the following items :
  - Charges - 2.105 item : if there is a link between the costs/fees/taxes and the globalisation
  - AdditionalEntryInformation – 2.314 item: additional information, if any, about the globalised transaction.

**XML-example** : see 7.4.1 – example-index 3.2 to 3.24

#### 4.1.2. Information registered under the 'Entry details' item – 2.135 :

- as for a single transaction, information can be retrieved from the following items :
  - TransactionDetails – 2.141 item : any additional information about the transaction
- as for globalised transactions, information can be retrieved from the following items :
  - Batch – 2.136 item : all batch elements
  - TransactionDetails 2.141item: all information about the details of a globalised transaction
  - AdditionalEntryInformation - 2.314 item : additional information, if any, about the transaction

**XML-example** : see 7.4.2 – example-index 4.25 to 4.89

### 4.1.3. Partial / gross amounts versus net amount :

In case a transaction consists of several partial amounts (eg. a batch booking or a transaction where charges or taxes are included), the net amount will be reported under the Amount – 2.78 item, and the partial amounts will be reported under EntryDetails – 2.135 item.

The sum of all partial amounts should equal the net amount.

Depending on your bank, in case the gross amount equals the net amount, the gross amount will not be reported under the EntryDetails – 2.135 item.

## 4.2. Reporting of Structured Creditor References to RemittanceInformation - 2.234 Item :

- There are two kinds of Structured Creditor References :
  - The Belgian Structured Creditor References .
 

The CreditorReference contains the Belgian 12 digit structured communication, with the last 2 digits as check digits (modulo 97) of the first 10 digits, but if the result is 0, then the check digits are 97. This Structured CreditorReferenceInformation is supported only by the Belgian banks
  - The ISO Structured Creditor References described in the ISO 11649-standard. (EPC approval expected by the end of 2008)
- In order to establish a distinct difference between the two Structured Creditor References, the Belgian Structured Creditor Reference will have 'BBA' as issuer; the ISO Structured Creditor Reference will have 'ISO' as issuer.
- Message implementation guide for Structured Creditor References :
  - General

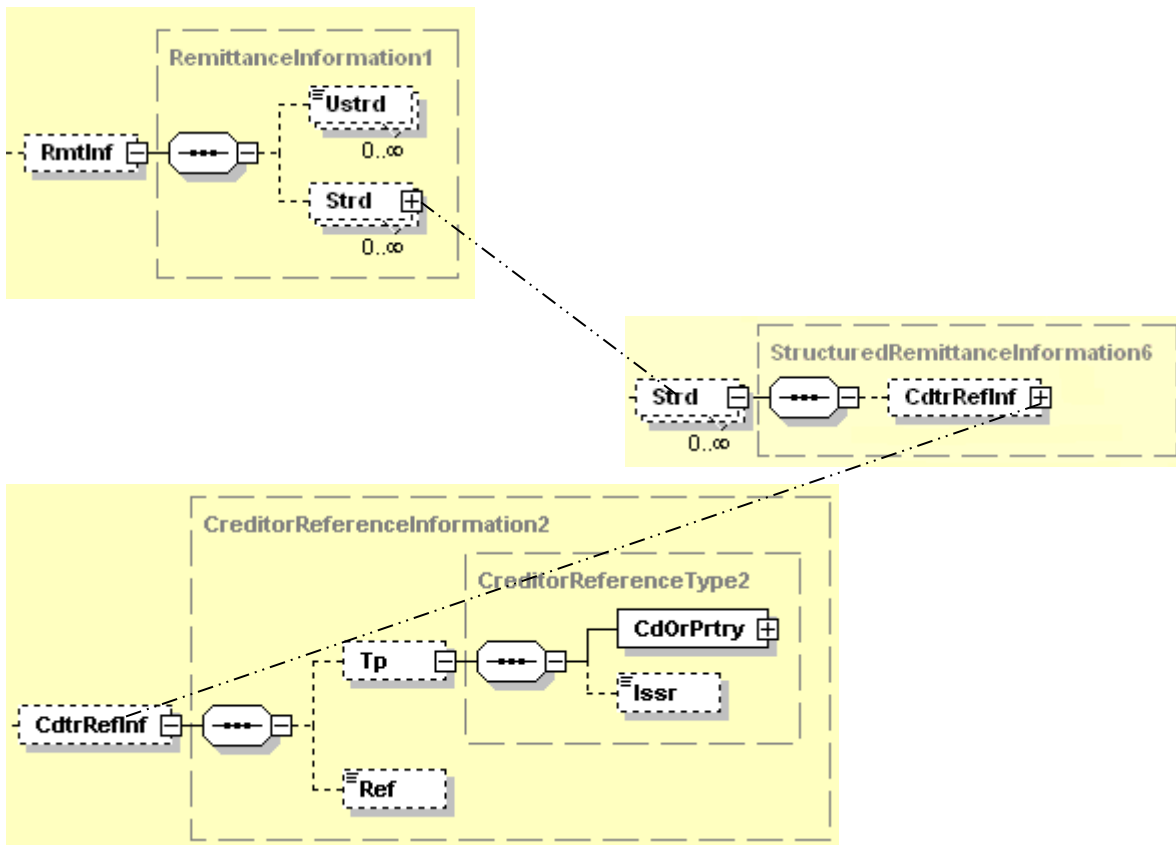

- Belgian Structured Creditor References

```
<RmtInf>
  <Strd>
    <CdtrRefInf>
      <Tp>
        <CdOrPrtry>
          <Cd>SCOR</Cd>
        </CdOrPrtry>
        <Issr>BBA</Issr>
      </Tp>
      <Ref>080762515551</Ref>
    </CdtrRefInf>
  </Strd>
</RmtInf>
```

- ISO Structured References

```
<RmtInf>
  <Strd>
    <CdtrRefInf>
      <Tp>
        <CdOrPrtry>
          <Cd>SCOR</Cd>
        </CdOrPrtry>
        <Issr>ISO</Issr>
      </Tp>
      <Ref>RF98123456789012345678901</Ref>
    </CdtrRefInf>
  </Strd>
</RmtInf>
```

### 4.3. Reporting of Structured Bank References :

Please contact your bank for more information about the contents of this remittance.

## 4.4 Reporting of costs, fees and taxes :

- Use of the 'Charges' – 2.172 item under 'TransactionDetails' – 2.142 item
- Use of the 'Tax' – 2.182 item, if tax is levied on a part of or on the whole of the costs and fees concerned

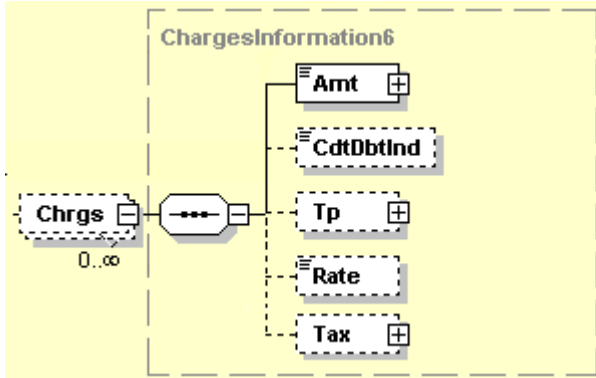

Whenever charges are reported the 'Charges' – 2.172 item will be used as many times as there are different charges – related to the same transaction – to be reported,

**The structure for a single charge – without tax levied on the charge – will be as follows :**

```

<Chrgs>
  <Amt Ccy="EUR">...</Amt>
  <CdtDbtInd>...</CdtDbtInd>
  <Tp>
    <Prtry>
      <Id>...</Id>
      <Issr>...</Issr>
    </Prtry>
  </Tp>
</Chrgs>

```

**The structure for several charges – with or without tax levied upon – will be as follows :**

```

<Chrgs>
  <Amt Ccy="EUR">...</Amt>
  <CdtDbtInd>...</CdtDbtInd>
  <Tp>
    <Prtry>
      <Id>...</Id>
      <Issr>...</Issr>
    </Prtry>
  </Tp>
  <Tax>
    <Id>...</Id>
    <Rate>...</Rate>
    <Amt Ccy="EUR">...</Amt>
  </Tax>
</Chrgs>

```

```

<Chrgs>
  <Amt Ccy="EUR">...</Amt>
  <CdtDbtInd>...</CdtDbtInd>
  <Tp>
    <Prtry>
      <Id>...</Id>
      <Issr>...</Issr>
    </Prtry>
  </Tp>
</Chrgs>

```

Or :

```

<Chrgs>
  <Amt Ccy="EUR">...</Amt>
  <CdtDbtInd>...</CdtDbtInd>
  <Tp>
    <Prtry>
      <Id>...</Id>
      <Issr>...</Issr>
    </Prtry>
  </Tp>
</Chrgs>

```

```

<Chrgs>
  <Amt Ccy="EUR">...</Amt>
  <CdtDbtInd>...</CdtDbtInd>
  <Tp>
    <Prtry>
      <Id>...</Id>
      <Issr>...</Issr>
    </Prtry>
  </Tp>
</Chrgs>

```

```

<Tax>
  <TtlTaxAmt>...</ TtlTaxAmt >
  <Rcrd>
    <Tp>...<Tp>
    <TaxAmt>
      <Rate>...</Rate>
      <TaxblBaseAmt>...</ TaxblBaseAmt >
      <TtlAmt>...</TtlAmt>
    </TaxAmt>
  </Rcrd>
</Tax>

```

**XML-example** : see 7.4.10

- If the costs, fees and taxes pertain to a globalised transaction, the information will be given under the 'Charges' – 2.105 item.

## 4.5. Reporting of Customer References from Pain-messages :

A Pain-message can contain different customer references such as MessageIdentification, PaymentInformationIdentification, InstructionIdentification and EndToEndInformation. If they occur in a Pain-message transaction, they will be reported as follows :

- For single transactions in the following items :
  - Under the References – 2.143 item :
    - MessageIdentification – 2.144 item
    - PaymentInformationIdentification – 2.146 item
    - InstructionIdentification – 2.147 item
    - EndToEndIdentification – 2.148 item
- For globalised transactions :
  - Under the Batch – 2.136 item :
    - MessageIdentification – 2.137 item
    - PaymentInformationIdentification – 2.138 item
  - Under the References – 2.143 item :
    - InstructionIdentification – 2.147 item
    - EndToEndIdentification – 2.148 item

# Pain-message

# XML REPORTING

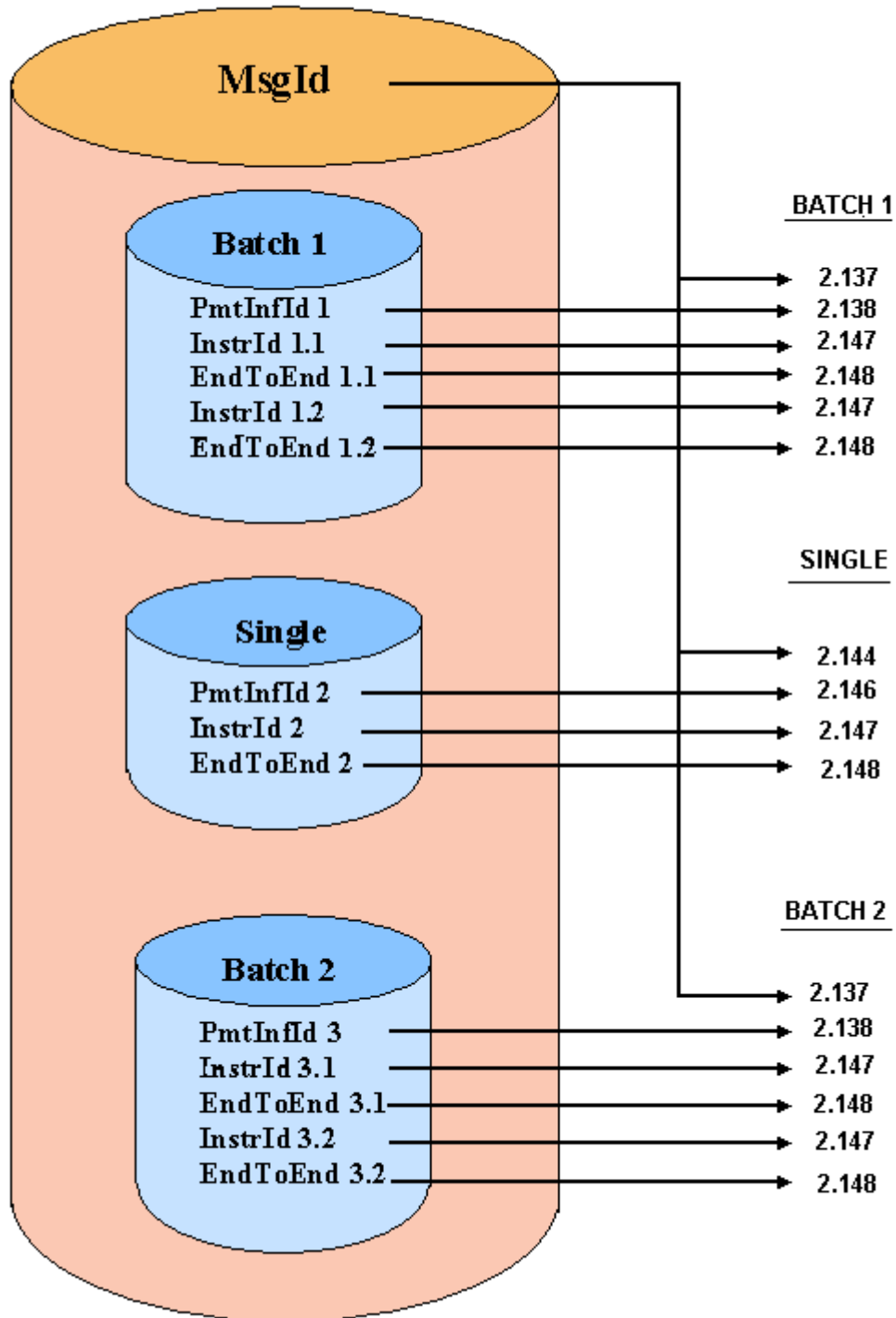



## 4.6. Reporting of the different kinds of amounts:

### ➤ **Booked amount on the account (globalised or single):**

Use of the 'Amount' – 2.78 item

### ➤ **Other kinds of amounts:**

Use of 'AmountDetails' – 2.156 item in accordance with the following rules:

- Amount related to a detail of a globalised transaction:
  - Use of the 'TransactionAmount' - 2.1.9 item
- Gross amount (before deduction of costs, fees and taxes) labeled in the currency of the reported account:
  - Use of the 'InstructedAmount' – 2.1.0 item
- Gross amount (before deduction of costs, fees and taxes) not labeled in the currency of the reported account:
  - Use of the 'InstructedAmount' -2.1.0 item to report the gross amount of the original transaction in its original currency
  - Use of the 'CounterValueAmount' – 2.1.18 item for the reporting of the counter value labeled in the currency of the reported account, of the original amount. All useful information about currency conversion will be given under this item.

#### **Optional for each bank:**

- Use of the 'ProprietaryAmount' – 2.1.36 item with one of the category codes mentioned in § 6.2 – Category being included in the 'type' -2.1.37 item for the reporting of more specific amounts (capital of a long-term investment...): .. .

- **Attention : if the amounts are related to a globalised transaction, the information will be given under the 'AmountDetails' – 2.104**

**XML-example** : see 7.4.2 – example-index 4.37 to 4.50

## 4.7. Reporting of the TransactionsSummary – 2.43 item:

Let's assume we have to report the following transactions in a statement :

- + 2.440,19
- + 482,40
- + 2926,20
- + 562,00
- - 442,00

The reporting of the TransactionSummary – 2.43 item will be as follows :

```
<TxSummary>
  <TtlNtries>
    <NbOfNtries>5</NbOfNtries>
    <Sum>6852.79</Sum>
    <TtlNetNtryAmt>5968.79</TtlNetNtryAmt>
    <CdtDbtInd>CRDT</CdtDbtInd>
  </TtlNtries>
  <TtlCdtNtries>
    <NbOfNtries>4</NbOfNtries>
    <Sum>6410.79</Sum>
  </TtlCdtNtries>
  <TtlDbtNtries>
    <NbOfNtries>1</NbOfNtries>
    <Sum>442.00</Sum>
  </TtlDbtNtries>
</TxSummary>
```

→ The sum off all transactions, regardless whether they are credit- or debet-transactions.

→ The sum off all transactions, taken in account whether they are credit- or debet-transactions.

→ Indicates whether the total net entry amount is a credit or a debit balance.

→ Number of individual credit entries included in the report.

→ Total of all individual credit entries included in the report.

→ Number of individual debit entries included in the report.

→ Total of all individual debit entries included in the report.

**XML-example** : see 7.3 – example-index 2.58 to 2.73

## 4.8. Miscellaneous

### 4.8.1. Separate files-messages

- The contents of a separate file message will be defined in the message header (cf. §2-Message Items Description-Index 1.5)

#### **4.8.2. Splitting up of messages**

- Depending on the information volume to be transferred, it will be possible to split up the message into several messages in accordance with the pagination rules mentioned in §3 – Message Item Description – index 1.4.
- The balance types mentioned in the 'intermediate' messages are described in §3 – Message Item Description – index 2.23.

#### **4.8.3. Specific encoding for Belgium :**

- A Belgian codification could be used in different 'proprietary' items. BBA (Belgian Bankers' and Stockbroking firms' Association) will then be used as 'issuer' in all types of specific Belgian encoding in the 'issuer' item, if it exists.

## 5. Bank Transaction Codes

The Bank Transaction Codes (hereafter BkTxCd) are an 'external code list' and serve as a complement to the Bank-To-Customer Cash Management messages (CamtXXX) as described in the ISO 20022-standard.

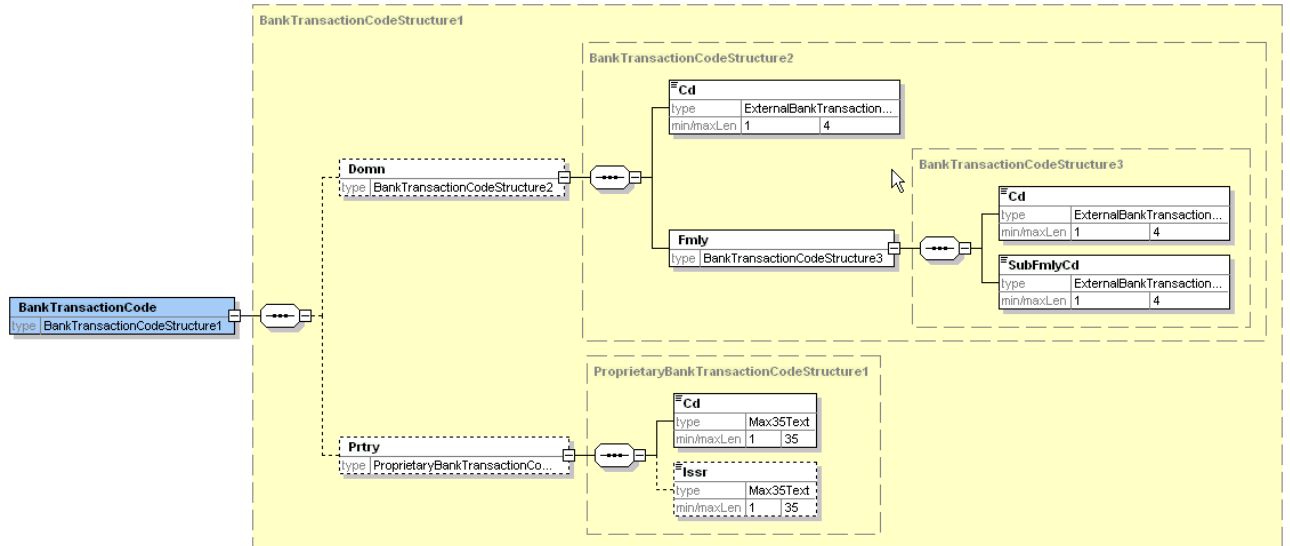

### 'Rules' governing the BkTxCd structure

- If Domain is absent, Proprietary must be present.
- If Proprietary is absent, Domain must be present.
- Domain and Proprietary may be present together.

### 5.1. BkTxCd structure under Camt053.001.02

Under Camt053.001.02, we find the BkTxCd both at the Entry and TransactionDetails level.

	XML tag	Index Entry level	Index TransactionDetails level
BankTransactionCode	<BkTxCd>	2.91	2.163
Domain	<Domn>	2.92	2.164
Code	<Cd>	2.93	2.165
Family	<Fmly>	2.94	2.166
Code	<Cd>	2.95	2.167
SubFamilyCode	<SubFmlyCd>	2.96	2.168
Proprietary	<Prtry>	2.97	2.169
Code	<Cd>	2.98	2.170
Issuer	<Issr>	2.99	2.171

## **The way in which the BkTxCd is built up**

There are three levels in the way in which a BkTxCd is built up :

### Domain

Highest level of transaction identification. The Domain serves as a high-level definition of the transaction business domain.

### Family

Transaction type definition.

### SubFamily

Lowest level containing even more detailed information about the kind of transaction which is the subject of reporting.

## **5.2. Double encoding**

The principle of double encoding applies, i.e. the encoding proper to MX.CAMT.053 as well as a 'proprietary' encoding which is specific for Belgium. The Belgian Bank Transaction Code will be reported in the Proprietary – 2.97 item or 2.169 item.

### **5.2.1. ISO Bank Transaction codes**

The [Bank Transaction Code lists description](#)

[http://www.iso20022.org/documents/External\\_code\\_lists/BTC\\_ExternalCodeListDescription\\_16June09.doc](http://www.iso20022.org/documents/External_code_lists/BTC_ExternalCodeListDescription_16June09.doc) ([http://www.iso20022.org/Payments\\_External\\_Code\\_Lists.page](http://www.iso20022.org/Payments_External_Code_Lists.page)) provides the detailed description of the external code lists and values to be used in the Bank Transaction Code structure.

### [BankTransactionCodes](#)

### **5.2.2. BBA Bank Transaction Code**

#### **Family** (1<sup>st</sup> + 2<sup>nd</sup> pos)

Gives the broad division a transaction belongs to. E.g. credit transfer, cards, collection,...

See appendix 6.1.

#### **Transaction** (3<sup>rd</sup> + 4<sup>th</sup> pos)

Identifies the transaction within a family. For each family code, there are a number of different debit or credit transaction codes.

See appendix 6.1.

#### **Category** (5<sup>th</sup> + 6<sup>th</sup> + 7<sup>th</sup> pos)

Provides additional information about the nature of the transaction. For each movement record, the category clearly distinguishes between the different items relating to a single transaction.

See appendix 6.2

#### **Remarks**

When a financial institution encounters a transaction which has not yet received a common code and which should be given one, code 39 or 89 will be given to the transaction within family 30. This will facilitate the allocation of a definitive code afterwards. Within each family, numbers 40 to 48 and 90 to 98 have been earmarked for the transactions which are proper to one bank and for which no common code is required immediately. Numbers 49 and 99 identify the correction and cancellation entries.

## 6. Appendix

### 6.1. Family and Transaction Codes

01 to 39 : domestic or local SEPA transactions 41 to 79 : foreign/non-SEPA transactions 80 to 89 : other families

01	Domestic or local SEPA credit transfers	41	International credit transfers - non-SEPA credit transfers
02	Instant SEPA credit transfer		
03	Cheques	43	Foreign cheques
04	Cards		
05	Direct debit		
07	Domestic commercial paper	47	Foreign commercial paper
09	Counter transactions		
11	Securities		
13	Credit		
30	Various transactions		
35	Closing (periodical settlements for interest, costs,...)		
80	Separately charged costs and provisions		

**Family: 01 = Domestic local/credit transfers – SEPA credit transfers**

<b>Family</b>	<b>Transaction code</b>	<b>Family</b>	<b>Specification of the transaction</b>	<b>Comment</b>
01	01	Domestic or local SEPA credit transfers	Individual transfer order	Credit transfer given by the customer on paper or electronically, even if the execution date of this transfer is in the future. Domestic payments as well as euro payments meeting the requirements.
01	02	Domestic or local SEPA credit transfers	Individual transfer order initiated by the bank	The bank takes the initiative for debiting the customer's account.
01	03	Domestic or local SEPA credit transfers	Standing order	Credit transfer for which the order has been given once and which is carried out again at regular intervals without any change.
01	05	Domestic or local SEPA credit transfers	Payment of wages, etc.	The principal will be debited for the total amount of the file entered.
01	07	Domestic or local SEPA credit transfers	Collective transfer	The principal will be debited for the total amount of the file entered.
01	13	Domestic or local SEPA credit transfers	Transfer from your account	Transfer from one account to another account of the same customer at the bank's or the customer's initiative (intracompany).
01	17	Domestic or local SEPA credit transfers	Financial centralisation	In case of centralisation by the bank, type 2 will be allotted to this transaction. This total can be followed by the detailed movement.
01	37	Domestic or local SEPA credit transfers	Costs	
01	39	Domestic or local SEPA credit transfers	Your issue circular cheque	To be used for issued circular cheques given in consignment
01	40 – 48	Domestic or local SEPA credit transfers	Codes proper to each bank	
01	49	Domestic or local SEPA credit transfers	Cancellation or correction	

<b>Family</b>	<b>Transaction code</b>	<b>Family</b>	<b>Specification of the transaction</b>	<b>Comment</b>
<b>Credit transactions</b>				
01	50	Domestic or local SEPA credit transfers	Transfer in your favour	
01	51	Domestic or local SEPA credit transfers	Transfer in your favour – initiated by the bank	The bank takes the initiative for crediting the customer's account.
01	52	Domestic or local SEPA credit transfers	Payment in your favour	Payment by a third person
01	54	Domestic or local SEPA credit transfers	Unexecutable transfer order	
01	60	Domestic or local SEPA credit transfers	Non-presented circular cheque	
01	62	Domestic or local SEPA credit transfers	Unpaid postal order	
01	64	Domestic or local SEPA credit transfers	Transfer to your account	Intracompany
01	66	Domestic or local SEPA credit transfers	Financial centralization	In case of centralisation by the bank, type 2 will be allotted to this transaction. This total can be followed by the detailed movement.
01	87	Domestic or local SEPA credit transfers	Reimbursement of costs	
01	90-98	Domestic or local SEPA credit transfers	Codes proper to each bank	
01	99	Domestic or local SEPA credit transfers	Cancellation or correction	



**Family: 02 = Instant SEPA credit transfers**

Family	Transaction code	Family	Specification of the transaction	Comment
Debit transactions				
02	01	Instant SEPA credit transfers	Individual transfer order	Credit transfer given by the customer.
02	02	Instant SEPA credit transfers	Individual transfer order initiated by the bank	The bank takes the initiative for debiting the customer's account.
02	03	Instant SEPA credit transfers	Standing order	Credit transfer for which the order has been given once and which is carried out again at regular intervals without any change
02	05	Instant SEPA credit transfers	Payment of wages, etc	The principal will be debited for the total amount of the file entered.
02	07	Instant SEPA credit transfers	Collective transfer	The principal will be debited for the total amount of the file entered.
02	13	Instant SEPA credit transfers	Transfer from your account	Transfer from one account to another account of the same customer at the bank's or the customer's initiative (intracompany).
02	17	Instant SEPA credit transfers	Financial centralisation	In case of centralisation by the bank, type 2 will be allotted to this transaction. This total can be followed by the detailed movement.
02	37	Instant SEPA credit transfers	Costs	
02	40-48	Instant SEPA credit transfers	Codes proper to each bank	
02	49	Instant SEPA credit transfers	Cancellation or correction	

Family	Transaction code	Family	Specification of the transaction	Comment
Credit transactions				
02	50	Instant SEPA credit transfers	Transfer in your favour	
02	51	Instant SEPA credit transfers	Transfer in your favour – initiated by the bank	The bank takes the initiative for crediting the customer's account.
02	52	Instant SEPA credit transfers	Payment in your favour	Payment by a third person
02	54	Instant SEPA credit transfers	Unexecutable transfer order	
02	64	Instant SEPA credit transfers	Transfer to your account	Intracompany
02	66	Instant SEPA credit transfers	Financial centralization	In case of centralisation by the bank, type 2 will be allotted to this transaction. This total can be followed by the detailed movement.
02	87	Instant SEPA credit transfers	Reimbursement of costs	
02	90-98	Instant SEPA credit transfers	Codes proper to each bank	

**Family: 03 = Cheques**

<b>Family</b>	<b>Transaction code</b>	<b>Family</b>	<b>Specification of the transaction</b>	<b>Comment</b>
<b>Debit transactions</b>				
03	01	Cheques	Payment of your cheque	
03	05	Cheques	Payment of voucher	Payment of holiday pay, etc.
03	09	Cheques	Unpaid voucher	
03	11	Cheques	Department store cheque	
03	15	Cheques	Your purchase bank cheque	Cheque drawn by the bank on itself, usually with charges.
03	17	Cheques	Your certified cheque	Amount of the cheque; if any, charges receive code 37
03	37	Cheques	Cheque-related costs	
03	38	Cheques	Provisionally unpaid	
03	40-48	Cheques	Codes proper to each bank	
03	49	Cheques	Cancellation or correction	
<b>Credit transactions</b>				
03	52	Cheques	First credit of cheques, vouchers, luncheon vouchers, postal orders, credit under usual reserve	
03	58	Cheques	Remittance of cheques, vouchers, etc. credit after collection	Also for vouchers, postal orders, anything but bills of exchange, acquittances, promissory notes, etc.
03	60	Cheques	Reversal of voucher	
03	62	Cheques	Reversal of cheque	cheques debited on account, but debit cancelled afterwards for lack of cover (double debit/contra-entry of transaction 01 or 05)
03	63	Cheques	Second credit of unpaid cheque	
03	66	Cheques	Remittance of cheque by your branch - credit under usual reserve	
03	87	Cheques	Reimbursement of cheque-related costs	Overall amount, VAT included
03	90-98	Cheques	Codes proper to each bank	
03	99	Cheques	Cancellation or correction	

**Family : 04 = Cards**

<b>Family code</b>	<b>Uniform code</b>	<b>Family</b>	<b>Specification of the transaction</b>	<b>Comment</b>
<b>Debit transactions</b>				
04	01	Cards	Loading a GSM card	Debit customer who is loading
04	02	Cards	Payment by means of a payment card within the Eurozone	Eurozone = countries which have the euro as their official currency
04	03	Cards	Settlement credit cards	
04	04	Cards	Cash withdrawal from an ATM	At home as well as abroad
04	05	Cards	Loading Proton	
04	06	Cards	Payment with tank card	
04	07	Cards	Payment by GSM	
04	08	Cards	Payment by means of a payment card outside the Eurozone	Eurozone = countries which have the euro as their official currency
04	37	Cards	Costs	Various costs for possessing or using a payment card
04	40-48	Cards	Codes proper to each bank	
04	49	Cards	Cancellation or correction	

<b>Family code</b>	<b>Uniform code</b>	<b>Family</b>	<b>Specification of the transaction</b>	<b>Comment</b>
<b>Credit transactions</b>				
04	50	Cards	Credit after a payment at a terminal	Except Proton
04	51	Cards	Unloading Proton	
04	52	Cards	Loading GSM cards	Credit provider
04	53	Cards	Cash deposit at an ATM	
04	55	Cards	Income from payments by GSM	
04	68	Cards	Credit after Proton payments	
04	87	Cards	Reimbursement of costs	
04	90 – 98	Cards	Codes proper to each bank	
04	99	Cards	Cancellation or correction	

**Family: 05 = Direct debit**

<b>Family code</b>	<b>Uniform code</b>	<b>Family</b>	<b>Specification of the transaction</b>	<b>Comment</b>
<b>Debit transactions</b>				
05	01	Direct Debit	Payment	
05	03	Direct Debit	Unpaid debt	
05	05	Direct Debit	Reimbursement	
05	37	Direct Debit	Costs	
05	40 – 48	Direct Debit	Codes proper to each institution	
05	49	Direct Debit	Cancellation or correction	
<b>Credit transactions</b>				
05	50	Direct Debit	Credit after collection	
05	52	Direct Debit	Credit under usual reserve	
05	54	Direct Debit	Reimbursement	
05	56	Direct Debit	Unexecutable reimbursement	
05	58	Direct Debit	Reversal	(cancellation of an undue debit of the debtor at the initiative of the financial institution or the debtor for lack of cover)
05	87	Direct Debit	Reimbursement of costs	
05	90-98	Direct Debit	Codes proper to each bank	
05	99	Direct Debit	Cancellation or correction	

**Family: 07 = Domestic commercial paper**

<b>Family code</b>	<b>Uniform code</b>	<b>Family</b>	<b>Specification of the transaction</b>	<b>Comment</b>
<b>Debit transactions</b>				
07	01	Domestic commercial paper	Payment commercial paper	Bills of exchange, acquittances, promissory notes; debit of the drawee
07	05	Domestic commercial paper	Commercial paper claimed back	Bill claimed back at the drawer's request (bill claimed back before maturity date)
07	06	Domestic commercial paper	Extension of maturity date	Costs chargeable to the remitter
07	07	Domestic commercial paper	Unpaid commercial paper	Contra-entry of a direct credit or of a discount
07	08	Domestic commercial paper	Payment in advance	Debit of the remitter when the drawee pays in advance directly to the remitter (regards bank acceptances)
07	09	Domestic commercial paper	Agio on supplier's bill	Debit of the agios to the account of the drawee
07	37	Domestic commercial paper	Costs related to commercial paper	If any, detail in the category (e.g. costs for presentation for acceptance, etc.)
07	39	Domestic commercial paper	Return of an irregular bill of exchange	Debit of the drawer after credit under usual reserve or discount
07	40-48	Domestic commercial paper	Codes proper to each bank	
07	49	Domestic commercial paper	Cancellation or correction	

<b>Family code</b>	<b>Uniform code</b>	<b>Family</b>	<b>Specification of the transaction</b>	<b>Comment</b>
<b>Credit transactions</b>				
07	50	Domestic commercial paper	Remittance of commercial paper - credit after collection	Credit of the remitter
07	52	Domestic commercial paper	Remittance of commercial paper - credit under usual reserve	
07	54	Domestic commercial paper	Remittance of commercial paper for discount	Among other things advances or promissory notes
07	56	Domestic commercial paper	Remittance of supplier's bill with guarantee	
07	58	Domestic commercial paper	Remittance of supplier's bill without guarantee	
07	87	Domestic commercial paper	Reimbursement of costs	
07	90-98	Domestic commercial paper	Codes proper to each bank	
07	99	Domestic commercial paper	Cancellation or correction	

**Family: 09 = Counter transactions**

<b>Family code</b>	<b>Uniform code</b>	<b>Family</b>	<b>Specification of the transaction</b>	<b>Comment</b>
<b>Debit transactions</b>				
09	01	Counter transactions	Cash withdrawal	Withdrawal by counter cheque or receipt; cash remitted by the bank clerk
09	05	Counter transactions	Purchase of foreign bank notes	
09	07	Counter transactions	Purchase of gold/pieces	
09	09	Counter transactions	Purchase of petrol coupons	
09	13	Counter transactions	Cash withdrawal by your branch or agents	On the account of the head office
09	17	Counter transactions	Purchase of fiscal stamps	
09	19	Counter transactions	Difference in payment	Used in case of payments accepted under reserve of count, result of overcrediting
09	25	Counter transactions	Purchase of traveller's cheque	
09	37	Counter transactions	Costs	
09	40-48	Counter transactions	Codes proper to each bank	
09	49	Counter transactions	Cancellation or correction	



<b>Family code</b>	<b>Uniform code</b>	<b>Family</b>	<b>Specification of the transaction</b>	<b>Comment</b>
<b>Credit transactions</b>				
09	50	Counter transactions	Cash payment	For own account - the comment for the client is given in the communication; also for mixed payments (cash + cheques) - not to be communicated to the clients; for payments made by a third person: see family 01
09	52	Counter transactions	Payment night safe	
09	58	Counter transactions	Payment by your branch/agents	Takes priority over transaction 52 (hence a payment made by an agent in a night safe = 58 and not 52)
09	60	Counter transactions	Sale of foreign bank notes	
09	62	Counter transactions	Sale of gold/pieces under usual reserve	
09	68	Counter transactions	Difference in payment	In case of payment accepted under reserve of count; result of undercrediting - see also transaction 19
09	70	Counter transactions	Sale of traveller's cheque	
09	87	Counter transactions	Reimbursement of costs	
09	90-98	Counter transactions	Codes proper to each bank	
09	99	Counter transactions	Cancellation or correction	

**Family: 11 = Securities**

<b>Family code</b>	<b>Uniform code</b>	<b>Family</b>	<b>Specification of the transaction</b>	<b>Comment</b>
<b>Debit transactions</b>				
11	01	Securities	Purchase of securities	Purchase of domestic or foreign securities, including subscription rights, certificates, etc.
11	02	Securities	Tenders	Payment to the bank on maturity date
11	03	Securities	Subscription to securities	Bonds, shares, tap issues of CDs, with or without payment of interest, etc.
11	04	Securities	Issues	
11	05	Securities	Partial payment subscription	Debit of the subscriber for the complementary payment of partly-paid shares
11	06	Securities	Share option plan – exercising an option	
11	09	Securities	Settlement of securities	For professionals (stockbrokers) only, whoever the issuer may be (Belgian or foreigner)
11	11	Securities	Payable coupons/repayable securities	Debit of the issuer by the bank in charge of the financial service
11	13	Securities	Your repurchase of issue	Unissued part (see 64)
11	15	Securities	Interim interest on subscription	In case of subscription before the interest due date
11	17	Securities	Management fee	
11	19	Securities	Regularisation costs	
11	37	Securities	Costs	
11	40-48	Securities	Codes proper to each bank	
11	49	Securities	Cancellation or correction	

<b>Family code</b>	<b>Uniform code</b>	<b>Family</b>	<b>Specification of the transaction</b>	<b>Comment</b>
<b>Credit transactions</b>				
11	50	Securities	Sale of securities	
11	51	Securities	Tender	Company issues paper in return for cash
11	52	Securities	Payment of coupons from a deposit or settlement of coupons delivered over the counter - credit under usual reserve	Whatever the currency of the security
11	58	Securities	Repayable securities from a deposit or delivered at the counter - credit under usual reserve	
11	62	Securities	Interim interest on subscription	When reimbursed separately to the subscriber
11	64	Securities	Your issue	Amount paid to the issuer by the bank in charge of the placement (firm underwriting or not); also used for the payment in full of partly-paid shares, see transaction 05
11	66	Securities	Retrocession of issue commission	For professionals such as insurances and stockbrokers
11	68	Securities	Compensation for missing coupon	In case coupons attached to a purchased security are missing
11	70	Securities	Settlement of securities	Only with stockbrokers when they deliver the securities to the bank
11	87	Securities	Reimbursement of costs	
11	90-98	Securities	Codes proper to each bank	
11	99	Securities	Cancellation or correction	

**Family: 13 = Credits**

<b>Family code</b>	<b>Uniform code</b>	<b>Family</b>	<b>Specification of the transaction</b>	<b>Comment</b>
<b>Debit transactions</b>				
13	01	Credits	Short-term loan	Capital and/or interest (specified by the category)
13	02	Credits	Long-term loan	
13	05	Credits	Settlement of fixed advance	Full or partial reimbursement of a fixed advance at maturity date
13	07	Credits	Your repayment instalment credits	Often by standing order or direct debit. In case of direct debit, family 13 is used.
13	11	Credits	Your repayment mortgage loan	
13	13	Credits	Settlement of bank acceptances	
13	15	Credits	Your repayment hire-purchase and similar claims	Hire-purchase agreement under which the financial institution is the lessor
13	19	Credits	Documentary import credits	
13	21	Credits	Other credit applications	
13	37	Credits	Credit-related costs	
13	40-48	Credits	Codes proper to each bank	
13	49	Credits	Cancellation or correction	

<b>Family code</b>	<b>Uniform code</b>	<b>Family</b>	<b>Specification of the transaction</b>	<b>Comment</b>
<b>Credit transactions</b>				
13	50	Credits	Settlement of instalment credit	
13	54	Credits	Fixed advance – capital and interest	
13	55	Credits	Fixed advance – interest only	
13	56	Credits	Subsidy	Interest or capital subsidy
13	60	Credits	Settlement of mortgage loan	
13	62	Credits	Term loan	
13	68	Credits	Documentary export credits	
13	70	Credits	Settlement of discount bank acceptance	
13	87	Credits	Reimbursement of costs	
13	90-98	Credits	Codes proper to each bank	
13	99	Credits	Cancellation or correction	

**Family: 30 = Miscellaneous transactions**

<b>Family code</b>	<b>Uniform code</b>	<b>Family</b>	<b>Specification of the transaction</b>	<b>Comment</b>
<b>Debit transactions</b>				
30	1	Miscellaneous transactions	Spot purchase of foreign exchange	
30	3	Miscellaneous transactions	Forward purchase of foreign exchange	
30	5	Miscellaneous transactions	Capital and/or interest term investment	
30	33	Miscellaneous transactions	Value (date) correction	
30	37	Miscellaneous transactions	Costs	
30	39	Miscellaneous transactions	Undefined transaction	
30	40-48	Miscellaneous transactions	Codes proper to each bank	
30	49	Miscellaneous transactions	Cancellation or correction	

<b>Family code</b>	<b>Uniform code</b>	<b>Family</b>	<b>Specification of the transaction</b>	<b>Comment</b>
<b>Credit transactions</b>				
30	50	Miscellaneous transactions	Spot sale of foreign exchange	
30	52	Miscellaneous transactions	Forward sale of foreign exchange	
30	54	Miscellaneous transactions	Capital and/or interest term investment	
30	55	Miscellaneous transactions	Interest term investment	
30	83	Miscellaneous transactions	Value (date) correction	
30	87	Miscellaneous transactions	Reimbursement of costs	
30	89	Miscellaneous transactions	Undefined transaction	
30	90-98	Miscellaneous transactions	Codes proper to each bank	
30	99	Miscellaneous transactions	Cancellation or correction	

**Family: 35 = Closing (e.g. periodical payments of interest, costs, ...)**

<b>Family code</b>	<b>Uniform code</b>	<b>Family</b>	<b>Specification of the transaction</b>	<b>Comment</b>
<b>Debit transactions</b>				
35	01	Closing	Closing	
35	37	Closing	Costs	
35	40-48	Closing	Codes proper to each bank	
35	49	Closing	Cancellation or correction	
<b>Credit transactions</b>				
35	50	Closing	Closing	
35	87	Closing	Reimbursement of costs	
35	90-98	Closing	Codes proper to each bank	
35	99	Closing	Cancellation or correction	

**Family: 41 = Foreign– non-SEPA credit transfers**

<b>Family code</b>	<b>Uniform code</b>	<b>Family</b>	<b>Specification of the transaction</b>	<b>Comment</b>
<b>Debit transactions</b>				
41	01	Foreign– non-SEPA credit transfers	Transfer	
41	03	Foreign– non-SEPA credit transfers	Standing order	
41	05	Foreign– non-SEPA credit transfers	Collective payments of wages	
41	07	Foreign– non-SEPA credit transfers	Collective transfers	
41	13	Foreign– non-SEPA credit transfers	Transfer from your account	Intracompany
41	17	Foreign– non-SEPA credit transfers	Financial centralisation (debit)	
41	37	Foreign– non-SEPA credit transfers	Costs relating to outgoing foreign transfers and non-SEPA transfers	
41	38	Foreign– non-SEPA credit transfers	Costs relating to incoming foreign and non-SEPA transfers	
41	40-48	Foreign– non-SEPA credit transfers	Codes proper to each bank	
41	49	Foreign– non-SEPA credit transfers	Cancellation or correction	
<b>Credit transactions</b>				
41	50	Foreign– non-SEPA credit transfers	Transfer	
41	64	Foreign– non-SEPA credit transfers	Transfer to your account	Intracompany
41	66	Foreign– non-SEPA credit transfers	Financial centralisation (credit)	
41	87	Foreign– non-SEPA credit transfers	Reimbursement of costs	
41	90-98	Foreign– non-SEPA credit transfers	Codes proper to each bank	
41	99	Foreign– non-SEPA credit transfers	Cancellation or correction	



**Family: 43 = Foreign cheques**

<b>Family code</b>	<b>Uniform code</b>	<b>Family</b>	<b>Specification of the transaction</b>	<b>Comment</b>
<b>Debit transactions</b>				
43	01	Foreign cheques	Payment of a foreign cheque	Debit of a cheque in foreign currency or in EUR in favour of a foreigner
43	07	Foreign cheques	Unpaid foreign cheque	Foreign cheque remitted for collection that returns unpaid
43	15	Foreign cheques	Purchase of an international bank cheque	
43	37	Foreign cheques	Costs relating to payment of foreign cheques	
43	40-48	Foreign cheques	Codes proper to each bank	
43	49	Foreign cheques	Cancellation or correction	
<b>Credit transactions</b>				
<b>Family code</b>	<b>Uniform code</b>	<b>Family</b>	<b>Specification of the transaction</b>	<b>Comment</b>
<b>Credit transactions</b>				
43	52	Foreign cheques	Remittance of foreign cheque credit under usual reserve	
43	58	Foreign cheques	Remittance of foreign cheque credit after collection	
43	62	Foreign cheques	Reversal of cheques	
43	87	Foreign cheques	Reimbursement of costs	
43	90-98	Foreign cheques	Codes proper to each bank	
43	99	Foreign cheques	Cancellation or correction	

**Family: 47 = Foreign commercial paper**

<b>Family code</b>	<b>Uniform code</b>	<b>Family</b>	<b>Specification of the transaction</b>	<b>Comment</b>
<b>Debit transactions</b>				
47	01	Foreign commercial paper	Payment of foreign bill	
47	05	Foreign commercial paper	Bill claimed back	
47	06	Foreign commercial paper	Extension	
47	07	Foreign commercial paper	Unpaid foreign bill	
47	11	Foreign commercial paper	Payment documents abroad	Bills of lading
47	13	Foreign commercial paper	Discount foreign supplier's bills	Debit customer, payment of agios, interest, exchange commission, etc.
47	14	Foreign commercial paper	Warrant fallen due	
47	37	Foreign commercial paper	Costs relating to the payment of a foreign bill	
47	40-48	Foreign commercial paper	Codes proper to each bank	
47	49	Foreign commercial paper	Cancellation or correction	

<b>Family code</b>	<b>Uniform code</b>	<b>Family</b>	<b>Specification of the transaction</b>	<b>Comment</b>
<b>Credit transactions</b>				
47	50	Foreign commercial paper	Remittance of foreign bill credit after collection	
47	52	Foreign commercial paper	Remittance of foreign bill credit under usual reserve	
47	54	Foreign commercial paper	Discount abroad	
47	56	Foreign commercial paper	Remittance of guaranteed foreign supplier's bill	
47	58	Foreign commercial paper	Idem without guarantee	
47	60	Foreign commercial paper	Remittance of documents abroad - credit under usual reserve	
47	62	Foreign commercial paper	Remittance of documents abroad - credit after collection	
47	64	Foreign commercial paper	Warrant	
47	87	Foreign commercial paper	Reimbursement of costs	
47	90-98	Foreign commercial paper	Codes proper to each bank	
47	99	Foreign commercial paper	Cancellation or correction	

**Family: 80 = Fees and commissions charged separately**

<b>Family code</b>	<b>Uniform code</b>	<b>Family</b>	<b>Specification of the transaction</b>	<b>Comment</b>
<b>Debit transactions</b>				
80	02	Fees and commissions charged separately	Costs relating to electronic output	
80	04	Fees and commissions charged separately	Costs for holding a documentary cash credit	
80	06	Fees and commissions charged separately	Damage relating to bills and cheques	
80	07	Fees and commissions charged separately	Insurance costs	'-insurance costs of account holders against fatal accidents - passing-on of several insurance costs
80	08	Fees and commissions charged separately	Registering compensation for savings accounts	
80	09	Fees and commissions charged separately	Postage	Postage recouped to the debit of the customer (including forwarding charges)
80	10	Fees and commissions charged separately	Purchase of Smartcard	
80	11	Fees and commissions charged separately	Costs for the safe custody of correspondence	Costs chargeable to clients who ask to have their correspondence kept at their disposal at the bank's counter
80	12	Fees and commissions charged separately	Costs for opening a bank guarantee	
80	13	Fees and commissions charged separately	Renting of safes	Commission for renting a safe deposit box
80	14	Fees and commissions charged separately	Handling costs instalment credit	
80	15	Fees and commissions charged separately	Night safe	Commission collected to the debit of the customer to whom the bank delivers a key which gives access to the night safe
80	16	Fees and commissions charged separately	Bank confirmation to revisor or accountant	
80	17	Fees and commissions charged separately	Charge for safe custody	Collected for unsealed deposit of securities, and other parcels
80	18	Fees and commissions charged separately	Trade information	
80	19	Fees and commissions charged separately	Special charge for safe custody	Collected for securities, gold, pass-books, etc. placed in safe custody
80	20	Fees and commissions charged separately	Drawing up a certificate	
80	21	Fees and commissions charged separately	Pay-packet charges	Charges for preparing pay packets

<b>Family code</b>	<b>Uniform code</b>	<b>Family</b>	<b>Specification of the transaction</b>	<b>Comment</b>
80	22	Fees and commissions charged separately	Management/custody	
80	23	Fees and commissions charged separately	Research costs	Costs charged for all kinds of research (information on past transactions, address retrieval, ...)
80	24	Fees and commissions charged separately	Participation in and management of interest refund system	
80	25	Fees and commissions charged separately	Renting of direct debit box	Commission for the renting of boxes put at the disposal for the correspondence
80	26	Fees and commissions charged separately	Travel insurance premium	
80	27	Fees and commissions charged separately	Subscription fee	For publications of the financial institution
80	29	Fees and commissions charged separately	Information charges	Charges collected for: - commercial information - sundry information
80	31	Fees and commissions charged separately	Writ service fee	E.g. for signing invoices
80	33	Fees and commissions charged separately	Miscellaneous fees and commissions	Costs not specified otherwise, often with a manual communication (e.g. for collecting, ordering funds). VAT excluded = type 0 VAT included = type 3 (at least 3 articles)
80	35	Fees and commissions charged separately	Costs	Costs charged for calculating the amount of the tax to be paid (e.g. Fiscomat).
80	37	Fees and commissions charged separately	Access right to database	Fixed right, either one-off or periodical; for details, see "categories"
80	39	Fees and commissions charged separately	Surety fee	Agios on guarantees given
80	41	Fees and commissions charged separately	Research costs	
80	43	Fees and commissions charged separately	Printing of forms	
80	45	Fees and commissions charged separately	Documentary credit charges	
80	47	Fees and commissions charged separately	Charging fees for transactions	
80	49	Fees and commissions charged separately	Cancellation or correction	

Family code	Uniform code	Family	Specification of the transaction	Comment
<b>Credit transactions</b>				
80	99	Fees and commissions charged separately	Cancellation or correction	

## 6.2. Category Codes

Uniform Code	Description of costs/fees	Comment
000	Net amount	Amount as mentioned on the statement
001	Interest credited	
002	Interest debited	
003	Credit fee	
004	Postage	
005	Letterbox rent	
006	Various costs and fees	
007	Right of access to databank	See also family 80 transaction 37
008	Information costs	e.g. commercial information, securities custody certificate, etc
009	Travelling costs	
010	Bailiff fee	
011	VAT	
012	Exchange fee	
013	Payment fee	
014	Collection charges	
015	Correspondent fee	
017	Study charges	
018	Rent guarantee charges	
019	Tax on physical delivery	e.g. securities
020	Physical delivery charges	e.g. securities
021	Charges for drawing a bank cheque	
022	Priority charges	Charges for swift money transfers
023	Execution fee	In case of a shares option plan
024	Growth premium	
025	Individual exchange costs account	
026	Handling charges	Manual processing of payments
027	Charges for dishonoured B/Es	
028	Fidelity premium	
029	Protest charges including cancellation charges	
030	Account Insurance	
031	Foreign cheque charges	
032	Drawing of a circular cheque	
033	Foreign security charges	
034	Reinvestment charges	In case of early partial reimbursement of a fixed advance
035	Foreign documentary security charges	
036	Refused cheque charges	
037	File handling costs	
039	Telecommunication	Confirmation of a foreign order to the beneficiary or to a third person
041	Credit card charges	
042	Payment card charges	
043	Insurance costs	
045	File handling costs	
047	Security prolongation charges	
049	Tax stamps/stamp duty	
050	Capital long term investment	

051	Withholding tax on income	Basic amount
052	(European) home country withholding tax	Basic amount
053	Drawing up of forms	
055	Loan or credit capital write-off	
057	Interest subsidy	
058	Capital premium	
059	Interest on arrears	
061	Transaction tariffing	
063	Rounding off differences	
065	Interest subsidy message	
066	Fixed credit advance – reimbursement	
067	Fixed credit advance – prolongation	
068	Entry countervalue	
069	Long-term arbitrage contracts : Amount to be paid by the customer	
070	Long-term arbitrage contracts : Amount to be paid by the bank	
071	Fixed credit advance – availability	
072	Third persons fees countervalue	
073	Foreign ATMs charges	
074	Correspondence costs	
100	Gross amount	Amount without fees and charges deducted
200	Total documentary credit cost	
201	Cancellation commission	
202	Notification commission Additional notification commission	
203	Confirmation commission Additional confirmation commission Commitment commission Flat commission Conformation reservation commission Additional reservation commission	
204	Modification commission	e.g. for securities
205	Documentary payment commission Documentary commission Use commission Negotiation commission	
206	Commission for conditional guarantees/ Payment	
207	Divergencies commission	
208	Commitment commission postponed payment	
209	Transfer commission	
210	Availability commission	
211	Credit opening fee Additional credit opening fee	
212	Storage charges	
213	Financing charges	
214	Issue charges (flow-through)	
400	Acceptance commission	
401	Visa charges	
402	Certification charges	
403	Minimum discount charges	
404	Discount charges	



405	Guarantee commission	
406	Collection charges	
407	Article 45 charges	
408	Opening charges	
409	Custody charges	e.g. as for securities offered for collection and with a maturity date that is still far off
410	Return charges	
411	Fixed collection charges	
412	Expiry message charges	
413	Acceptance charges	
414	Regularisation charges	
415	Commission for securing	
416	Charges for suretyship	Charges retransferred to the <i>Caisse des dépôts et consignations</i>
418	Endorsement commission	
419	Intervention commission	e.g. as for presenting a security for acceptance
420	Deduction charges	Charges deducted from a discount yield e.g. as for insufficient guarantee
425	Foreign brokerage	Tax included
426	Belgian brokerage	
427	Belgian stock exchange tax	
428	Interest yield	Only as for securities transactions
429	Foreign stock exchange tax	
430	Foreign tax recovery	
431	Copy delivery	e.g. commercial paper copy

## 7. Examples

The examples are preceded by two indexes:

- a. A = Example-Index:  
This example-index is made to facilitate the reading of these guidelines. All items are numbered consecutively, in order to have unique references to the examples.
- b. B = MX.CAMT053.001.02-Index:  
This index represents the exact index numbering of the CAMT053.001.02.

### 7.1. XMLHeader

```
<?xml version="1.0" encoding="UTF-8"?>
<Document xmlns="urn:iso:std:iso:20022:tech:xsd:camt.053.001.02"
xmlns:xsi="http://www.w3.org/2001/XMLSchema-instance">
  <BkToCstmrStmtV01>
```

### 7.2. GroupHeader

A	B	A = Example-Index	B = MX.CAMT053.001.02-Index
1.1	1.0		<GrpHdr>
1.2	1.1		<MsgId> <b>XML-Example</b> </MsgId>
1.3	1.2		<CreDtTm> <b>2009-05-12T00:00:00</b> </CreDtTm>
1.4	1.3		<MsgRcpt>
1.5	9.1.0		<Nm> <b>Name Recipient</b> </Nm>
1.6			</MsgRcpt>
1.7	1.4		<MsgPgntn>
1.8	8.2.0		<PgNb> <b>1</b> </PgNb>
1.9	8.2.1		<LastPgInd> <b>YES</b> </LastPgInd>
1.10			</MsgPgntn>
1.11	1.5		</GrpHdr>

### 7.3. Statement

Sequencenumber electronic message : **128**  
 Sequencenumber statement on paper : **130**  
 Reporting Period : **29/04/2009**  
 Reported account : **BE55 4429 6884 7144**  
 Old balance : **+ 1773.75**  
 New balance : **+ 7742.54**  
 Company number : **00462920226**

-----  
 Transactions : + 2440.19  
 + 482.40  
 + 2926.20  
 + 562.00  
 - 442.00  
 -----

A	B	A = Example-Index B = MX.CAMT053.001.02-Index
2.1	2.0	<Stmt>
2.2	2.1	<Id> <b>XML-Example_2009-05-12T00:00:00</b> </Id>
2.3	2.2	<ElectrcSeqNb> <b>128</b> </ElectrcSeqNb>
2.4	2.3	<LglSeqNb> <b>130</b> </LglSeqNb>
2.5	2.4	<CreDtTm> <b>2009-05-12T00:00:00</b> </CreDtTm>
2.6	2.5	<FrToDt>
2.7	5.1.0	<FrDtTm> <b>2009-04-29T00:00:00</b> </FrDtTm>
2.8	5.1.1	<ToDtTm> <b>2009-04-29T00:00:00</b> </ToDtTm>
2.9		</FrToDt>
2.10	2.10	<Acct>
2.11	1.2.0	<Id>
2.12	1.2.1	<IBAN> <b>BE55442968847144</b> </IBAN>
2.13		</Id>
2.14	1.2.8	<Tp>
2.15	1.2.10	<Prtry> <b>Account Type</b> </Prtry>
2.16		</Tp>
2.17	1.2.11	<Ccy> <b>EUR</b> </Ccy>
2.18	1.2.13	<Owvr>
2.19	1.2.14	<Nm> <b>Name Accountowner</b> </Nm>
2.20	1.2.26	<Id>
2.21	1.2.27	<OrgId>
2.22	1.2.29	<Othr>
2.23	1.2.30	<Id> <b>00462920226</b> </Id>
2.24		</Othr>
2.25		</OrgId>
2.26		</Id>
2.27		</Owvr>
2.28	1.2.56	<Svcr>
2.29	1.2.57	<FinInstnId>
2.30	1.2.58	<BIC> <b>ABANKBEB</b> </BIC>
2.31		</FinInstnId>
2.32		</Svcr>
2.33		</Acct>
2.34	2.23	<Bal>
2.35	2.24	<Tp>
2.36	2.25	<CdOrPrtry>
2.37	2.26	<Cd> <b>OPBD</b> </Cd>
2.38		</CdOrPrtry>
2.39		</Tp>
2.40	2.34	<Amt Ccy="EUR"> <b>1773.75</b> </Amt>
2.41	2.35	<CdtDbtInd> <b>CRDT</b> </CdtDbtInd>

A	B	A = Example-Index	B = MX.CAMT053.001.02-Index
2.42	2.36		<Dt>
2.43	4.1.0		<Dt> <b>2009-04-28</b> </Dt>
2.44			</Dt>
2.45			</Bal>
2.46	2.23		<Bal>
2.47	2.24		<Tp>
2.48	2.25		<CdOrPrtry>
2.49	2.26		<Cd> <b>CLBD</b> </Cd>
2.50			</CdOrPrtry>
2.51			</Tp>
2.52	2.34		<Amt Ccy="EUR"> <b>7742.54</b> </Amt>
2.53	2.35		<CdtDbtInd> <b>CRDT</b> </CdtDbtInd>
2.54	2.36		<Dt>
2.55	4.1.0		<Dt> <b>2009-04-29</b> </Dt>
2.56			</Dt>
2.57			</Bal>
2.58	2.43		<TxSummary>
2.59	2.44		<TtlNtries>
2.60	2.45		<NbOfNtries> <b>5</b> </NbOfNtries>
2.61	2.46		<Sum> <b>6852.79</b> </Sum>
2.62	2.47		<TtlNetNtryAmt> <b>5968.79</b> </TtlNetNtryAmt>
2.63	2.48		<CdtDbtInd> <b>CRDT</b> </CdtDbtInd>
2.64			</TtlNtries>
2.65	2.49		<TtlCdtNtries>
2.66	2.50		<NbOfNtries> <b>4</b> </NbOfNtries>
2.67	2.51		<Sum> <b>6410.79</b> </Sum>
2.68			</TtlCdtNtries>
2.69	2.52		<TtlDbtNtries>
2.70	2.53		<NbOfNtries> <b>1</b> </NbOfNtries>
2.71	2.54		<Sum> <b>442.00</b> </Sum>
2.72			</TtlDbtNtries>
2.73			</TxSummary>
2.74	2.76		<Ntry>
2.75			...
2.76			</Ntry>
2.77	2.76		<Ntry>
2.78			...
2.79			</Ntry>
2.80			...
2.81			...
2.82			</Stmt>

## 7.4. Entries

### 7.4.1. SCT Transfer - single

Booking date : **20/10/08**  
 Value date : **19/10/08**  
 Account counterparty : **DE79 3704 0044 0123 6199 00**  
 BIC bank counterparty : **COBADEFF370**  
 Counterparty Name : **HOTEL RESERVATION**

-----  
 Net Amount : **- 1024.03**  
 -----

Communication : **INV 2150135**

A	B	A = Example-Index	B = MX.CAMT053.001.02-Index
3.1	2.76	<Ntry>	
3.2	2.78	<Amt Ccy="EUR"> <b>1024.03</b> </Amt>	
3.3	2.79	<CdtDbtInd> <b>DBIT</b> </CdtDbtInd>	
3.4	2.81	<Sts> <b>BOOK</b> </Sts>	
3.5	2.82	<BookgDt>	
3.6	4.1.0	<Dt> <b>20081020</b> </Dt>	
3.7		</BookgDt>	
3.8	2.83	<ValDt>	
3.9	4.1.0	<Dt> <b>20081019</b> </Dt>	
3.10		</ValDt>	
3.11	2.84	<AcctSvcrRef> <b>Bank Reference</b> </AcctSvcrRef>	
3.12	2.91	<BkTxCd>	
3.13	2.92	<Domn>	
3.14	2.93	<Cd> <b>PMNT</b> </Cd>	
3.15	2.94	<Fmly>	
3.16	2.95	<Cd> <b>ICDT</b> </Cd>	
3.17	2.96	<SubFmlyCd> <b>ESCT</b> </SubFmlyCd>	
3.18		</Fmly>	
3.19		</Domn>	
3.20	2.97	<Prtry>	
3.21	2.98	<Cd> <b>0101000</b> </Cd>	
3.22	2.99	<Issr> <b>BBA</b> </Issr>	
3.23		</Prtry>	
3.24		</BkTxCd>	
3.25	2.135	<NtryDtls>	
3.26	2.142	<TxDtls>	
3.27	2.199	<RltdPties>	
3.28	2.204	<Cdtr>	
3.29	9.1.0	<Nm> <b>HOTEL RESERVATION</b> </Nm>	
3.30		</Cdtr>	
3.31	2.205	<CdtrAcct>	
3.32	1.1.0	<Id>	
3.33	1.1.1	<IBAN> <b>DE79370400440123619900</b> </IBAN>	
3.34		</Id>	
3.35		</CdtrAcct>	
3.36		</RltdPties>	
3.37	2.211	<RltdAgts>	
3.38	2.213	<CdtrAgt>	
3.39	6.1.0	<FinInstnId>	
3.40	6.1.1	<BIC> <b>COBADEFF370</b> </BIC>	
3.41		</FinInstnId>	
3.42		</CdtAgt>	
3.43		</RltdAgts>	
3.44	2.234	<RmtInf>	
3.45	2.235	<Ustrd> <b>INV 2150135</b> </Ustrd>	
3.46		</RmtInf>	
3.47		</TxDtls>	

A	B	A = Example-Index	B = MX.CAMT053.001.02-Index
3.48		</NtryDtIs>	
3.49		</Ntry>	

## 7.4.2. International transfers - collective

Booking Date : **08/07/08**  
 Value date : **07/07/08**  
 Batch reference : **GD081900000191**

-----  
 Total net amount : **- 29.214,47**  
 -----

### Payment 1

Your reference : **5100071347**  
 Account counterparty : **GB46 RBOS 1604 0020 1774 05**  
 Counterparty Name : **IBOS**  
 Counterparty Address : **3 LONDON WALL BUILDINGS**  
 Locality counterparty : **EC2M5PP LONDON**  
 Counterparty Country : **GB**  
 Communication : **200815**  
 Banker counterparty : **ROYAL BANK OF SCOTLAND PLC**

-----  
 Net amount : **- 9.514,53 EUR**  
 -----

Gross Amount : **- 9.514,53 EUR**  
 -----

Gross Amount in the currency of the account : **9.514,53**  
 Gross Amount in original currency : **7.500,00**  
 Exchange rate : **0,78826800**  
 Currency : **GBP**

### Payment 2

Your reference : **5100071348**  
 Account counterparty : **217502032065**  
 Counterparty Name : **FINQUEST PARTNERS LLC**  
 Counterparty Address : **14 WALL STREET 20TH FLOO**  
 Locality counterparty : **US 10005 NEW YORK USA**  
 Counterparty Country : **US**  
 Communication : **080623**  
 Banker counterparty : **JPMORGAN CHASE BANK NA**

-----  
 Net Amount : **- 10.893,47 EUR**  
 -----

Gross Amount : **- 10.893,47 EUR**  
 -----

Gross Amount in the currency of the account : **10.893,47**  
 Gross Amount in original currency : **16.930,68**  
 Exchange rate : **1,55420500**  
 Currency : **USD**

Payment 3

Your reference : **5100071349**  
Account counterparty : **FR76 3000 4008 0100 0215 5321 831**  
BIC bank counterparty : **BNPAFRPP**  
Counterparty Name : **MUREX**  
Counterparty Address : **8 RUE BELLINI**  
Locality counterparty : **75782 PARIS CEDEX 16**

-----  
Net amount : **- 8.800,00 EUR**  
-----

Payment 4

Your reference : **5100071350**  
Account counterparty : **PL101050 0099 5521 0000 0076 4605**  
  
Counterparty Name : **POLENERGIA SA**  
Address Counterparty : **CHMIELNA 85/87**  
Locality counterparty : **PL 00-805WARSZAWA POLE**  
Counterparty Country : **PL**

Communication : **01/0002434/1608R**  
Banker counterparty : **ING Bank Slaski SA**

-----  
Net Amount : **- 6,47 EUR**  
-----

Gross Amount : **- 6,47 EUR**  
-----

Gross Amount in the currency of the account : **6.47**  
Gross Amount in original currency : **21.12**  
Exchange rate : **3,26358800**  
Currency : **PLN**

A	B	A = Example-Index	B = MX.CAMT053.001.02-Index
4.1	2.76	<Ntry>	
4.2	2.78	<Amt Ccy="EUR"> <b>29214.47</b> </Amt>	
4.3	2.79	<CdtDbtInd> <b>DBIT</b> </CdtDbtInd>	
4.4	2.81	<Sts> <b>BOOK</b> </Sts>	
4.5	2.82	<BookgDt>	
4.6	4.1.0	<Dt> <b>20080708</b> </Dt>	
4.7		</BookgDt>	
4.8	2.83	<ValDt>	
4.9	4.1.0	<Dt> <b>20080707</b> </Dt>	
4.10		</ValDt>	
4.11	2.84	<AcctSvcrRef> <b>Bank Reference</b> </AcctSvcrRef>	
4.12	2.91	<BkTxCd>	
4.13	2.92	<Domn>	
4.14	2.93	<Cd> <b>PMNT</b> </Cd>	
4.15	2.94	<Fmly>	
4.16	2.95	<Cd> <b>ICDT</b> </Cd>	
4.17	2.96	<SubFmlyCd> <b>XBCT</b> </SubFmlyCd>	
4.18		</Fmly>	
4.19		</Domn>	
4.20	2.97	<Prtry>	
4.21	2.98	<Cd> <b>4101000</b> </Cd>	
4.22	2.99	<Issr> <b>BBA</b> </Issr>	
4.23		</Prtry>	
4.24		</BkTxCd>	
4.25	2.135	<NtryDtIs>	
4.26	2.136	<Btch>	
4.27	2.138	<PmtInfId> <b>GD0819000000191</b> </PmtInfId>	
4.28	2.139	<NbOfTx> <b>4</b> </NbOfTx>	

A	B	A = Example-Index	B = MX.CAMT053.001.02-Index
4.29	2.140		<TtlAmt Ccy="EUR"> <b>29214.47</b> </TtlAmt>
4.30	2.141		<CdtDbtInd> <b>DBIT</b> </CdtDbtInd>
4.31			</Btch>
4.32	2.142		<TxDtIs>
4.33	2.143		<Refs>
4.34	2.145		<AcctSvcrRef> <b>Bank Reference</b> </AcctSvcrRef>
4.35	2.148		<EndToEndId> <b>5100071347</b> </EndToEndId>
4.36			</Refs>
4.37	2.156		<AmtDtIs>
4.38	2.1.0		<InstdAmt>
4.39	2.1.1		<Amt Ccy="GBP"> <b>7500</b> </Amt>
4.40			</InstdAmt>
4.41	2.1.18		<CntrValAmt>
4.42	2.1.19		<Amt Ccy="EUR"> <b>9514.53</b> </Amt>
4.43	2.1.20		<CcyXchg>
4.44	2.1.21		<SrcCcy> <b>GBP</b> </SrcCcy>
4.45	2.1.22		<TrgtCcy> <b>EUR</b> </TrgtCcy>
4.46	2.1.23		<UnitCcy> <b>EUR</b> </UnitCcy>
4.47	2.1.24		<XchgRate> <b>0.78826800</b> </XchgRate>
4.48			</CcyXchg>
4.49			</CntrValAmt>
4.50			</AmtDtIs>
4.51	2.163		<BkTxCd>
4.52	2.164		<Domn>
4.53	2.165		<Cd> <b>PMNT</b> </Cd>
4.54	2.166		<Fmly>
4.55	2.167		<Cd> <b>ICDT</b> </Cd>
4.56	2.168		<SubFmlyCd> <b>XBCT</b> </SubFmlyCd>
4.57			</Fmly>
4.58			</Domn>
4.59	2.169		<Prtry>
4.60	2.170		<Cd> <b>4101000</b> </Cd>
4.61	2.171		<Issr> <b>BBA</b> </Issr>
4.62			</Prtry>
4.63			</BkTxCd>
4.64	2.199		<RltdPties>
4.65	2.204		<Cdtr>
4.66	9.1.0		<Nm> <b>IBOS</b> </Nm>
4.67	9.1.1		<PstlAdr>
4.68	9.1.11		<AdrLine> <b>LONDON WALL BUILDIN EC2M5PP LONDON GB</b> </AdrLine>
4.69			</PstlAdr>
4.70			</Cdtr>
4.71	2.205		<CdtrAcct>
4.72	1.1.0		<Id>
4.73	1.1.1		<IBAN> <b>GB46RBOS16040020177405</b> </IBAN>
4.74			</Id>
4.75			</CdtrAcct>
4.76			</RltdPties>
4.77	2.211		<RltdAgts>
4.78	2.213		<CdtrAgt>
4.79	6.1.0		<FinInstnId>
4.80	6.1.7		<Nm> <b>ROYAL BANK OF SCOTLAND PLC</b> </Nm>
4.81			</FinInstnId>
4.82			</CdtrAgt>
4.83			</RltdAgts>
4.84	2.234		<RmtInf>
4.85	2.235		<Ustrd> <b>200815</b> </Ustrd>
4.86			</RmtInf>
4.87			</TxDtIs>
4.88	2.142		<TxDtIs>
4.89	2.143		<Refs>
4.90	2.145		<AcctSvcrRef> <b>Bank Reference</b> </AcctSvcrRef>
4.91	2.148		<EndToEndId> <b>5100071348</b> </EndToEndId>
4.92			</Refs>



A	B	A = Example-Index	B = MX.CAMT053.001.02-Index
4.93	2.156		<AmtDtIs>
4.94	2.1.0		<InstdAmt>
4.95	2.1.1		<Amt Ccy="USD"> <b>16930.68</b> </Amt>
4.96			</InstdAmt>
4.97	2.1.18		<CntrValAmt>
4.98	2.1.19		<Amt Ccy="EUR"> <b>10893.47</b> </Amt>
4.99	2.1.20		<CcyXchg>
4.100	2.1.21		<SrcCcy> <b>USD</b> </SrcCcy>
4.101	2.1.22		<TrgtCcy> <b>EUR</b> </TrgtCcy>
4.102	2.1.23		<UnitCcy> <b>EUR</b> </UnitCcy>
4.103	2.1.24		<XchgRate> <b>1.55420500</b> </XchgRate>
4.104			</CcyXchg>
4.105			</CntrValAmt>
4.106			</AmtDtIs>
4.107	2.163		<BkTxCd>
4.108	2.164		<Domn>
4.109	2.165		<Cd> <b>PMNT</b> </Cd>
4.110	2.166		<Fmly>
4.111	2.167		<Cd> <b>ICDT</b> </Cd>
4.112	2.168		<SubFmlyCd> <b>XBCT</b> </SubFmlyCd>
4.113			</Fmly>
4.114			</Domn>
4.115	2.169		<Prtry>
4.116	2.170		<Cd> <b>4101000</b> </Cd>
4.117	2.171		<Issr> <b>BBA</b> </Issr>
4.118			</Prtry>
4.119			</BkTxCd>
4.120	2.199		<RltdPties>
4.121	2.204		<Cdtr>
4.122	9.1.0		<Nm> <b>FINQUEST PARTNERS LLC</b> </Nm>
4.123	9.1.1		<PstlAdr>
4.124	9.1.11		<AdrLine> <b>WALL STREET 20 US-10005 NEW YORK US</b> </AdrLine>
4.125			</PstlAdr>
4.126			</Cdtr>
4.127	2.205		<CdtrAcct>
4.128	1.1.0		<Id>
4.129	1.1.2		<Othr>
4.130	1.1.3		<Id> <b>217502032065</b> </Id>
4.131			</Othr>
4.132			</Id>
4.133			</CdtrAcct>
4.134			</RltdPties>
4.135	2.211		<RltdAgts>
4.136	2.213		<CdtrAgt>
4.137	6.1.0		<FinInstnId>
4.138	6.1.7		<Nm> <b>JPMORGAN CHASE BANK NA</b> </Nm>
4.139			</FinInstnId>
4.140			</CdtrAgt>
4.141			</RltdAgts>
4.142	2.234		<RmtInf>
4.143	2.235		<Ustrd> <b>080623</b> </Ustrd>
4.144			</RmtInf>
4.145			</TxDtIs>
4.146	2.142		<TxDtIs>
4.147	2.143		<Refs>
4.148	2.145		<AcctSvcrRef> <b>Bank Reference</b> </AcctSvcrRef>
4.149	2.18		<EndToEndId> <b>5100071349</b> </EndToEndId>
4.150			</Refs>
4.151	2.156		<AmtDtIs>
4.152	2.1.9		<TxAmt>
4.153	2.1.10		<Amt Ccy="EUR"> <b>8800</b> </Amt>
4.154			</TxAmt>
4.155			</AmtDtIs>
4.156	1.163		<BkTxCd>

A	B	A = Example-Index	B = MX.CAMT053.001.02-Index
4.157	2.164		<Domn>
4.158	2.165		<Cd> <b>PMNT</b> </Cd>
4.159	2.166		<Fmly>
4.160	2.167		<Cd> <b>ICDT</b> </Cd>
4.161	2.168		<SubFmlyCd> <b>ESCT</b> </SubFmlyCd>
4.162			</Fmly>
4.163			</Domn>
4.164	2.169		<Prtry>
4.165	2.170		<Cd> <b>4101000</b> </Cd>
4.166	2.171		<Issr> <b>BBA</b> </Issr>
4.167			</Prtry>
4.168			</BkTxCd>
4.169	2.199		<RltdPties>
4.170	2.204		<Cdtr>
4.171	9.1.0		<Nm> <b>MUREX</b> </Nm>
4.172	9.1.1		<PstlAdr>
4.173	9.1.11		<AdrLine> <b>RUE BELLINI 8 75782 PARIS CEDEX 16 FR</b> </AdrLine>
4.174			</PstlAdr>
4.175			</Cdtr>
4.176	2.205		<CdtrAcct>
4.177	1.1.0		<Id>
4.178	1.1.1		<IBAN> <b>FR76300040080...</b> </IBAN>
4.179			</Id>
4.180			</CdtrAcct>
4.181			</RltdPties>
4.182	2.211		<RltdAgts>
4.183	2.213		<CdtrAgt>
4.184	6.1.0		<FinInstnId>
4.185	6.1.1		<BIC> <b>BNPAFRPP</b> </BIC>
4.186			</FinInstnId>
4.187			</CdtrAgt>
4.188			</RltdAgts>
4.189	2.234		<RmtInf>
4.190	2.235		<Ustrd> <b>01000-005948</b> </Ustrd>
4.191			</RmtInf>
4.192			</TxDtIs>
4.193	2.142		<TxDtIs>
4.194	2.143		<Refs>
4.195	2.145		<AcctSvcrRef> <b>Bank Reference</b> </AcctSvcrRef>
4.196	2.148		<EndToEndId> <b>5100071350</b> </EndToEndId>
4.197			</Refs>
4.198	2.156		<AmtDtIs>
4.199	2.1.0		<InstdAmt>
4.200	2.1.1		<Amt Ccy="PLN"> <b>21.12</b> </Amt>
4.201			</InstdAmt>
4.202	2.1.18		<CntrValAmt>
4.203	2.1.19		<Amt Ccy="EUR"> <b>6.47</b> </Amt>
4.204	2.1.20		<CcyXchg>
4.205	2.1.21		<SrcCcy> <b>PLN</b> </SrcCcy>
4.206	2.1.22		<TrgtCcy> <b>EUR</b> </TrgtCcy>
4.207	2.1.23		<UnitCcy> <b>EUR</b> </UnitCcy>
4.208	2.1.24		<XchgRate> <b>3.26358800</b> </XchgRate>
4.209			</CcyXchg>
4.210			</CntrValAmt>
4.211			</AmtDtIs>
4.212	2.163		<BkTxCd>
4.213	2.164		<Domn>
4.214	2.165		<Cd> <b>PMNT</b> </Cd>
4.215	2.166		<Fmly>
4.216	2.167		<Cd> <b>ICDT</b> </Cd>
4.217	2.168		<SubFmlyCd> <b>XBCT</b> </SubFmlyCd>
4.218			</Fmly>
4.219			</Domn>
4.220	2.169		<Prtry>

A	B	A = Example-Index	B = MX.CAMT053.001.02-Index
4.221	2.170		<Cd> <b>4101000</b> </Cd>
4.222	2.171		<Issr> <b>BBA</b> </Issr>
4.223			</Prtry>
4.224			</BkTxCd>
4.225	2.199		<RltdPties>
4.226	2.204		<Cdtr>
4.227	9.1.0		<Nm> <b>POLENERGIA S.A.</b> </Nm>
4.228	9.1.1		<PstlAdr>
4.229	9.1.11		<AdrLine> <b>CHMIELNA 85/87 00-805 WARSAWA PL</b> </AdrLine>
4.230			</PstlAdr>
4.231			</Cdtr>
4.232	2.205		<CdtrAcct>
4.233	1.1.0		<Id>
4.234	1.1.1		<IBAN> <b>PL10105000995521000000764605</b> </IBAN>
4.235			</Id>
4.236			</CdtrAcct>
4.237			</RltdPties>
4.238	2.211		<RltdAgts>
4.239	2.213		<CdtrAgt>
4.240	6.1.0		<FinInstnId>
4.241	6.1.7		<Nm> <b>ING BANK SLASKI SA</b> </Nm>
4.242			</FinInstnId>
4.243			</CdtrAgt>
4.244			</RltdAgts>
4.245	2.234		<RmtInf>
4.246	2.235		<Ustrd> <b>01/0002434/1608R</b> </Ustrd>
4.247			</RmtInf>
4.248			</TxDtIs>
4.249			</NtryDtIs>
4.250			</Ntry>

### 7.4.3. Charges, Fees and Taxes

Securities, payment of coupons

Booking Date : **10/10/08**  
 Value Date : **13/10/08**

Net Amount : **+ 8,82 EUR**

Gross Amount : **+ 19,21 EUR**

Communication : **OSCP000000024996999**

Foreign tax : **- 3,46 EUR**

Withholding tax : **- 3,94 EUR**

Amount in the currency of the account : **3,94**  
 Amount on which percentage was calculated : **15,75**  
 Percent : **25 %**

Collection fee : **- 2,47 EUR**

VAT : **- 0,52 EUR**

Amount in the currency of the account : **0,52**  
 Amount on which percentage was calculated : **2,47**  
 Percent : **21 %**

A	B	A = Example-Index	B = MX.CAMT053.001.02-Index
5.1	2.76	<Ntry>	
5.2	2.78	<Amt Ccy="EUR"> <b>8.82</b> </Amt>	
5.3	2.79	<CdtDbtInd> <b>CRDT</b> </CdtDbtInd>	
5.4	2.81	<Sts> <b>BOOK</b> </Sts>	
5.5	2.82	<BookgDt>	
5.6	4.1.0	<Dt> <b>20081010</b> </Dt>	
5.7		</BookgDt>	
5.8	2.83	<ValDt>	
5.9	4.1.0	<Dt> <b>20081013</b> </Dt>	
5.10		</ValDt>	
5.11	2.84	<AcctSvcrRef> <b>Bank Reserve</b> </AcctSvcrRef>	
5.12	2.91	<BkTxCd>	
5.13	2.92	<Domn>	
5.14	2.93	<Cd> <b>SECU</b> </Cd>	
5.15	2.94	<Fmly>	
5.16	2.95	<Cd> <b>CORP</b> </Cd>	
5.17	2.96	<SubFmlyCd> <b>INTR</b> </SubFmlyCd>	
5.18		</Fmly>	
5.19		</Domn>	
5.20	2.97	<Prtry>	
5.21	2.98	<Cd> <b>1152000</b> </Cd>	
5.22	2.99	<Issr> <b>BBA</b> </Issr>	
5.23		</Prtry>	
5.24		</BkTxCd>	
5.25	2.135	<NtryDtIs>	
5.26	2.142	<TxDtIs>	
5.27	2.156	<AmtDtIs>	
5.28	2.1.36	<PrtryAmt>	
5.29	2.1.37	<Tp> <b>100</b> </Tp>	

A	B	A = Example-Index	B = MX.CAMT053.001.02-Index
5.30	2.1.38		<Amt Ccy="EUR">19.21</Amt>
5.31			</PrtryAmt>
5.32			</AmtDtls>
5.33	2.172		<Chrgs>
5.34	2.174		<Amt Ccy="EUR">2.47</Amt>
5.35	2.175		<CdtDbtInd>DBIT</CdtDbtInd>
5.36	2.176		<Tp>
5.37	2.178		<Prtry>
5.38	7.1.0		<Id>014</Id>
5.39	7.1.1		<Issr>BBA</Issr>
5.40			</Prtry>
5.41			</Tp>
5.42	2.182		<Tax>
5.43	2.183		<Id>011</Id>
5.44	2.184		<Rate>0.21</Rate>
5.45	2.185		<Amt Ccy="EUR">0.52</Amt>
5.46			</Tax>
5.47			</Chrgs>
5.48	2.234		<RmtInf>
5.49	2.235		<Ustrd>OSCP000000024996999</Ustrd>
5.50			</RmtInf>
5.51	2.292		<Tax>
5.52	13.1.15		<TtlTaxAmt Ccy="EUR">7.4</TtlTaxAmt>
5.53	13.1.18		<Rcrd>
5.54	13.1.19		<Tp>051</Tp>
5.55	13.1.31		<TaxAmt>
5.56	13.1.32		<Rate>0.25</Rate>
5.57	13.1.33		<TaxblAmt Ccy="EUR">15.75</TaxblAmt>
5.58	13.1.34		<TtlAmt Ccy="EUR">3.94</TtlAmt>
5.59			</TaxAmt>
5.60			</Rcrd>
5.61	13.1.18		<Rcrd>
5.62	13.1.19		<Tp>429</Tp>
5.63	13.1.31		<TaxAmt>
5.64	13.1.34		<TtlAmt Ccy="EUR">3.46</TtlAmt>
5.65			</TaxAmt>
5.66			</Rcrd>
5.67			</Tax>
5.68			</TxDtls>
5.69			</NtryDtls>
5.70			</Ntry>

## 7.4.4. Interests

Loans, Settlement of fixed deposit

Booking Date : **08/10/07**  
Value Date : **08/10/07**

Account number counterparty : **726-4849257-16**

Net Amount : **- 250.959,98 EUR**

Communication : **PARTIAL FIXED ADVANCE**

Fixed loan - repayment : **- 250.000,00 EUR**

Interest paid : **- 923,61 EUR**

Various fees and charges : **- 36,37 EUR**

A	B	A = Example-Index B = MX.CAMT053.001.02-Index
6.1	2.76	<Ntry>
6.2	2.78	<Amt Ccy="EUR"> <b>250959.98</b> </Amt>
6.3	2.79	<CdtDbtInd> <b>DBIT</b> </CdtDbtInd>
6.4	2.81	<Sts> <b>BOOK</b> </Sts>
6.5	2.82	<BookgDt>
6.6	4.1.0	<Dt> <b>20081007</b> </Dt>
6.7		</BookgDt>
6.8	2.83	<ValDt>
6.9	4.1.0	<Dt> <b>20081007</b> </Dt>
6.10		</ValDt>
6.11	2.84	<AcctSvcrRef> <b>Bank Reference</b> </AcctSvcrRef>
6.12	2.91	<BkTxCd>
6.13	2.92	<Domn>
6.14	2.93	<Cd> <b>LDAS</b> </Cd>
6.15	2.94	<Fmly>
6.16	2.95	<Cd> <b>FTLN</b> </Cd>
6.17	2.96	<SubFmlyCd> <b>DDWN</b> </SubFmlyCd>
6.18		</Fmly>
6.19		</Domn>
6.20	2.97	<Prtry>
6.21	2.98	<Cd> <b>1305000</b> </Cd>
6.22	2.99	<Issr> <b>BBA</b> </Issr>
6.23		</Prtry>
6.24		</BkTxCd>
6.25	2.135	<NtryDtls>
6.26	2.142	<TxDtls>
6.27	2.156	<AmtDtls>
6.28	2.1.36	<PrtryAmt>
6.29	2.1.37	<Tp> <b>066</b> </Tp>
6.30	2.1.38	<Amt Ccy="EUR"> <b>250000</b> </Amt>
6.31		</PrtryAmt>
6.32		</AmtDtls>
6.33	2.172	<Chrgs>
6.34	2.174	<Amt Ccy="EUR"> <b>36.37</b> </Amt>
6.35	2.175	<CdtDbtInd> <b>DBIT</b> </CdtDbtInd>
6.36	2.176	<Tp>
6.40	2.178	<Prtry>
6.41	7.1.0	<Id> <b>006</b> </Id>
6.42	7.1.1	<Issr> <b>BBA</b> </Issr>
6.43		</Prtry>

A	B	A = Example-Index	B = MX.CAMT053.001.02-Index
6.44			</Tp>
6.45			</Chrgs>
6.46	2.186		<Intrst>
6.47	2.187		<Amt Ccy="EUR">923.61</Amt>
6.48	2.188		<CdtDbtInd>DBIT</CdtDbtInd>
6.49	2.189		<Tp>
6.50	2.191		<Prtry>002</Prtry>
6.51			</Tp>
6.52			</Intrst>
6.53	2.199		<RltdPties>
6.54	2.205		<CdtrAcct>
6.55	1.1.0		<Id>
6.56	1.1.2		<Othr>
6.57	1.1.3		<Id>726484925716</Id>
6.58			</Othr>
6.59			</Id>
6.60			</CdtrAcct>
6.61			</RltdPties>
6.62	2.234		<RmtInf>
6.63	2.235		<Ustrd>PARTIAL FIXED ADVANCE</Ustrd>
6.64			</RmtInf>
6.65			</TxDtIs>
6.66			</NtryDtIs>
6.67			</Ntry>

#### 7.4.5. Direct Debit (DOM'80) - credit

Debits, invoices Remise - credit

Your reference : **5110702192**  
 Booking Date : **20/10/08**  
 Value Date **21/10/08**

-----  
 Total net amount : **+ 1.463,73 EUR**

##### Direct debit 1

-----  
 Net Amount : **+ 684,88 EUR**  
 -----  
 Debit number : **740-6784975-96**  
 Central (pivot) Date : **21/10/2008**  
 Structured Communication : **\*\*\*111050940656\*\*\***  
 Creditor Number : **00403136453**

##### Direct debit 2

-----  
 Net Amount : **+ 778,85 EUR**  
 -----  
 Debit number : **861-0140483-85**  
 Central (pivot) Date : **21/10/2008**  
 Structured Communication : **\*\*\*111050940858\*\*\***  
 Creditor Number : **00403136453**

A	B	A = Example-Index	B = MX.CAMT053.001.02-Index
7.1	2.76		<Ntry>
7.2	2.78		<Amt Ccy="EUR">1463.73</Amt>
7.3	2.79		<CdtDbtInd>CRDT</CdtDbtInd>
7.4	2.81		<Sts>BOOK</Sts>

A	B	A = Example-Index	B = MX.CAMT053.001.02-Index
7.5	2.82	<BookgDt>	
7.6	4.1.0	<Dt> <b>20081020</b> </Dt>	
7.7		</BookgDt>	
7.8	2.83	<ValDt>	
7.9	4.1.0	<Dt> <b>20081021</b> </Dt>	
7.10		</ValDt>	
7.11	2.84	<AcctSvcrRef> <b>Bank Reference</b> </AcctSvcrRef>	
7.12	2.91	<BkTxCd>	
7.13	2.92	<Domn>	
7.14	2.93	<Cd> <b>PMNT</b> </Cd>	
7.15	2.94	<Fmly>	
7.16	2.95	<Cd> <b>IDDT</b> </Cd>	
7.17	2.96	<SubFmlyCd> <b>URDD</b> </SubFmlyCd>	
7.18		</Fmly>	
7.19		</Domn>	
7.20	2.97	<Prtry>	
7.21	2.98	<Cd> <b>0552000</b> </Cd>	
7.22	2.99	<Issr> <b>BBA</b> </Issr>	
7.23		</Prtry>	
7.24		</BkTxCd>	
7.25	2.135	<NtryDtls>	
7.26	2.136	<Btch>	
7.27	2.138	<PmtInfId> <b>5110702192</b> </PmtInfId>	
7.28	2.139	<NbOfTx> <b>2</b> </NbOfTx>	
7.29	2.140	<TtlAmt Ccy="EUR"> <b>1463.73</b> </TtlAmt>	
7.30	2.141	<CdtDbtInd> <b>CRDT</b> </CdtDbtInd>	
7.31		</Btch>	
7.32	2.142	<TxDtls>	
7.33	2.143	<Refs>	
7.34	2.145	<AcctSvcrRef> <b>DOMDCDDID01</b> </AcctSvcrRef>	
7.35	2.150	<MndtId> <b>740678497596</b> </MndtId>	
7.36		</Refs>	
7.37	2.156	<AmtDtls>	
7.38	2.1.9	<TxAmt>	
7.39	2.1.10	<Amt Ccy="EUR"> <b>684.88</b> </Amt>	
7.40		</TxAmt>	
7.41		</AmtDtls>	
7.42	2.199	<RltdPties>	
7.43	2.204	<Cdtr>	
7.44	9.1.12	<Id>	
7.45	9.1.13	<OrgId>	
7.46	9.1.15	<Othr	
7.47	9.1.16	<Id> <b>00403136453</b> </Id>	
7.48		</Othr>	
7.49		</OrgId>	
7.50		</Id>	
7.51		</Cdtr>	
7.52		</RltdPties>	
7.53	2.234	<RmtInf>	
7.54	2.236	<Strd>	
7.55	2.256	<CdtrRefInf>	
7.56	2.257	<Tp>	
7.57	2.258	<CdOrPrtry>	
7.58	2.259	<Cd> <b>SCOR</b> </Cd>	
7.59		</CdOrPrtry>	
7.60	2.261	<Issr> <b>BBA</b> </Issr>	
7.61		</Tp>	
7.62	2.262	<Ref> <b>111050940656</b> </Ref>	
7.63		</CdtrRefInf>	
7.64		</Strd>	
7.65		</RmtInf>	
7.66	2.266	<RltdDtls>	
7.67	2.267	<AccptncDtTm> <b>20081021T00:00:00</b> </AccptncDtTm>	
7.68		</RltdDtls>	
7.69		</TxDtls>	



A	B	A = Example-Index	B = MX.CAMT053.001.02-Index
7.70	2.142		<TxDtIs>
7.71	2.143		<Refs>
7.72	2.145		<AcctSvcrRef> <b>DOMDCDDID01</b> </AcctSvcrRef>
7.73	2.150		<MndtId> <b>861014048385</b> </MndtId>
7.74			</Refs>
7.75	2.156		<AmtDtIs>
7.76	2.1.9		<TxAmt>
7.77	2.1.10		<Amt Ccy="EUR"> <b>778.85</b> </Amt>
7.78			</TxAmt>
7.79			</AmtDtIs>
7.80	2.199		<RltdPtIs>
7.81	2.204		<Ctr>
7.82	9.1.12		<Id>
7.83	9.1.13		<OrgId>
7.84	9.1.15		<Othr>
7.85	9.1.16		<Id> <b>00403136453</b> </Id>
7.86			</Othr>
7.87			</OrgId>
7.88			</Id>
7.89			</Ctr>
7.90			</RltdPtIs>
7.91	2.234		<RmtInf>
7.92	2.236		<Strd>
7.93	2.256		<CtrRefInf>
7.94	2.257		<Tp>
7.95	2.258		<CdOrPrtry>
7.96	2.259		<Cd> <b>SCOR</b> </Cd>
7.97			</CdOrPrtry>
7.98	2.261		<Issr> <b>BBA</b> </Issr>
7.99			</Tp>
7.100	2.262		<Ref> <b>111050940858</b> </Ref>
7.101			</CtrRefInf>
7.102			</Strd>
7.103			</RmtInf>
7.104	2.266		<RltdDtIs>
7.105	2.267		<AcptncDtTm> <b>20081021T00:00:00</b> </AcptncDtTm>
7.106			</RltdDtIs>
7.107			</TxDtIs>
7.108			</NtryDtIs>
7.109			</Ntry>

#### 7.4.6. Unpaid direct debits (DOM'80)

Booking Date : 16/10/08  
Value Date : 16/10/08

-----  
Total net amount : - 148,70 EUR  
-----

##### Unpaid direct debit 1

Your reference : 41306 008752585539

-----  
Net Amount : - 13,05 EUR  
-----

Debit number : 740-9078316-66

Central (pivot) Date : 16/10/2008

Communication : 008752585539

Creditor Number : 00456810810

Reason for denial : Other reason

##### Unpaid direct debit 2

Your reference : 41306 008752198650

-----  
Net Amount : - 23,14 EUR  
-----

Debit number : 740-5835360-14

Central (pivot) Date : 16/10/2008

Communication : 008752198650

Creditor Number : 00456810810

Reason for denial : Other reason

##### Unpaid direct debit 3

Your reference : 41306 008759092320

-----  
Net Amount : - 37,77 EUR  
-----

Debit number : 740-7218205-27

Central (pivot) Date : 16/10/2008

Communication : 008759092320

Creditor Number : 00456810810

Reason for denial : Other reason

##### Unpaid direct debit 4

Your reference : 41306 008759093128

-----  
Net Amount : - 74,74 EUR  
-----

Debit number : 740-7218206-28

Central (pivot) Date : 16/10/2008

Communication : 008759093128

Creditor Number : 00456810810

Reason for denial : Mandate is cancelled or invalid

A	B	A = Example-Index	B = MX.CAMT053.001.02-Index
8.1	2.76	<Ntry>	
8.2	2.78	<Amt Ccy="EUR"> <b>148.7</b> </Amt>	
8.3	2.79	<CdtDbtInd> <b>DBIT</b> </CdtDbtInd>	
8.4	2.80	<RvslInd> <b>TRUE</b> </RvslInd>	
8.5	2.81	<Sts> <b>BOOK</b> </Sts>	
8.6	2.82	<BookgDt>	
8.7	4.1.0	<Dt> <b>20081016</b> </Dt>	
8.8		</BookgDt>	
8.9	2.83	<ValDt>	
8.10	4.1.0	<Dt> <b>20081016</b> </Dt>	
8.11		</ValDt>	
8.12	2.84	<AcctSvcrRef> <b>Bank Reference</b> </AcctSvcrRef>	
8.13	2.91	<BkTxCd>	
8.14	2.92	<Domn>	
8.15	2.93	<Cd> <b>PMNT</b> </Cd>	
8.16	2.94	<Fmly>	
8.17	2.95	<Cd> <b>IDDT</b> </Cd>	
8.18	2.96	<SubFmlyCd> <b>UPDD</b> </SubFmlyCd>	
8.19		</Fmly>	
8.20		</Domn>	
8.21	2.97	<Prtry>	
8.22	2.98	<Cd> <b>0503000</b> </Cd>	
8.23	2.99	<Issr> <b>BBA</b> </Issr>	
8.24		</Prtry>	
8.25		</BkTxCd>	
8.26	2.135	<NtryDtls>	
8.27	2.136	<Btch>	
8.28	2.139	<NbOfTx> <b>4</b> </NbOfTx>	
8.29	2.140	<TtlAmt Ccy="EUR"> <b>148.7</b> </TtlAmt>	
8.30	2.141	<CdtDbtInd> <b>DBIT</b> </CdtDbtInd>	
8.31		</Btch>	
8.32	2.142	<TxDtls>	
8.33	2.143	<Refs>	
8.34	2.145	<AcctSvcrRef> <b>Bank Reference</b> </AcctSvcrRef>	
8.35	2.148	<EndToEndId> <b>4130 6008752585539</b> </EndToEndId>	
8.36	2.150	<MndtId> <b>740907831666</b> </MndtId>	
8.37		</Refs>	
8.38	2.156	<AmtDtls>	
8.39	2.1.9	<TxAmt>	
8.40	2.1.10	<Amt Ccy="EUR"> <b>13.05</b> </Amt>	
8.41		</TxAmt>	
8.42		</AmtDtls>	
8.43	2.199	<RltdPties>	
8.44	2.204	<Ctr>	
8.45	9.1.12	<Id>	
8.46	9.1.13	<OrgId>	
8.47	9.1.15	<Othr>	
8.48	9.1.16	<Id> <b>00456810810</b> </Id>	
8.49		</Othr>	
8.50		</OrgId>	
8.51		</Id>	
8.52		</Ctr>	
8.53		</RltdPties>	
8.54	2.234	<RmtInf>	
8.55	2.235	<Ustrd> <b>8752585539</b> </Ustrd>	
8.56		</RmtInf>	
8.57	2.266	<RltdDts>	
8.58	2.267	<AcptncDtTm> <b>20081016T00:00:00</b> </AcptncDtTm>	
8.59		</RltdDts>	
8.60	2.293	<RtrInf>	
8.61	2.304	<Rsn>	
8.62	2.305	<Cd> <b>MS03</b> </Cd>	
8.63		</Rsn>	
8.64		</RtrInf>	
8.65		</TxDtls>	

A	B	A = Example-Index	B = MX.CAMT053.001.02-Index
8.66	2.142		<TxDtIs>
8.67	2.143		<Refs>
8.68	2.145		<AcctSvcrRef> <b>Bank Reference</b> </AcctSvcrRef>
8.69	2.148		<EndToEndId> <b>41306 8752198650</b> </EndToEndId>
8.70	2.150		<MndtId> <b>740583536014</b> </MndtId>
8.71			</Refs>
8.72	2.156		<AmtDtIs>
8.73	2.1.9		<TxAmt>
8.74	2.1.10		<Amt Ccy="EUR"> <b>23.14</b> </Amt>
8.75			</TxAmt>
8.76			</AmtDtIs>
8.77	2.199		<RltdPtIs>
8.78	2.204		<Cdtr>
8.79	9.1.12		<Id>
8.80	9.1.13		<OrgId>
8.81	9.1.15		<Othr>
8.82	9.1.16		<Id> <b>00456810810</b> </Id>
8.83			</Othr>
8.84			</OrgId>
8.85			</Id>
8.86			</Cdtr>
8.87			</RltdPtIs>
8.88	2.234		<RmtInf>
8.89	2.235		<Ustrd> <b>8752198650</b> </Ustrd>
8.90			</RmtInf>
8.91	2.266		<RltdDtIs>
8.92	2.267		<AcptncDtTm> <b>20081016T00:00:00</b> </AcptncDtTm>
8.93			</RltdDtIs>
8.94	2.293		<RtrInf>
8.95	2.304		<Rsn>
8.96	2.305		<Cd> <b>MS03</b> </Cd>
8.97			</Rsn>
8.98			</RtrInf>
8.99			</TxDtIs>
8.100	2.142		<TxDtIs>
8.101	2.143		<Refs>
8.102	2.145		<AcctSvcrRef> <b>Bank Reference</b> </AcctSvcrRef>
8.103	2.148		<EndToEndId> <b>41306 8759092320</b> </EndToEndId>
8.104	2.150		<MndtId> <b>740721820527</b> </MndtId>
8.105			</Refs>
8.106	2.156		<AmtDtIs>
8.107	2.1.9		<TxAmt>
8.108	2.1.10		<Amt Ccy="EUR"> <b>37.77</b> </Amt>
8.109			</TxAmt>
8.110			</AmtDtIs>
8.111	2.199		<RltdPtIs>
8.112	2.204		<Cdtr>
8.113	9.1.12		<Id>
8.114	9.1.13		<OrgId>
8.115	9.1.15		<Othr>
8.116	9.1.16		<Id> <b>00456810810</b> </Id>
8.117			</Othr>
8.118			</OrgId>
8.119			</Id>
8.120			</Cdtr>
8.121			</RltdPtIs>
8.122	2.234		<RmtInf>
8.123	2.235		<Ustrd> <b>8759092320</b> </Ustrd>
8.124			</RmtInf>
8.125	2.266		<RltdDtIs>
8.126	2.267		<AcptncDtTm> <b>20081016T00:00:00</b> </AcptncDtTm>
8.127			</RltdDtIs>
8.128	2.293		<RtrInf>
8.129	2.304		<Rsn>
8.130	2.305		<Cd> <b>MS03</b> </Cd>

A	B	A = Example-Index	B = MX.CAMT053.001.02-Index
8.131			</Rsn>
8.132			</RtrInf>
8.133			</TxDtIs>
8.134	2.142		<TxDtIs>
8.135	2.143		<Refs>
8.136	2.145		<AcctSvcrRef> <b>Bank Reference</b> </AcctSvcrRef>
8.137	2.148		<EndToEndId> <b>41306 8759093128</b> </EndToEndId>
8.138	2.150		<MndtId> <b>740721820628</b> </MndtId>
8.139			</Refs>
8.140	2.156		<AmtDtIs>
8.141	2.1.9		<TxAmt>
8.142	2.1.10		<Amt Ccy="EUR"> <b>74.74</b> </Amt>
8.143			</TxAmt>
8.144			</AmtDtIs>
8.145	2.199		<RltdPtIs>
8.146	2.204		<Ctr>
8.147	9.1.12		<Id>
8.148	9.1.13		<OrgId>
8.149	9.1.15		<Othr>
8.150	9.1.16		<Id> <b>00456810810</b> </Id>
8.151			</Othr>
8.152			</OrgId>
8.153			</Id>
8.154			</Ctr>
8.155			</RltdPtIs>
8.156	2.234		<RmtInf>
8.157	2.235		<Ustrd> <b>8759093128</b> </Ustrd>
8.158			</RmtInf>
8.159	2.266		<RltdDtIs>
8.160	2.267		<AcptncDtTm> <b>20081016T00:00:00</b> </AcptncDtTm>
8.161			</RltdDtIs>
8.162	2.293		<RtrInf>
8.163	2.304		<Rsn>
8.164	2.305		<Cd> <b>MD01</b> </Cd>
8.165			</Rsn>
8.166			</RtrInf>
8.167			</TxDtIs>
8.168			</NtryDtIs>
8.169			</Ntry>

### 7.4.7. Received payments with a Structured Creditor Reference

Booking Date : 20/10/2008  
 Value Date : 20/10/2008

-----  
 Total net amount : + 61,15 EUR  
 -----

Payment 1

Account counterparty : **BE35 7320 1695 4237**  
 BIC bank counterparty : **CREGBEBB**  
 Counterparty Name : **HAYETTE CHRISTOPHE**  
 Counterparty Address : **PLACE DE WISBECQ 20**  
 Locality counterparty : **1430 REBECQ**

-----  
 Net Amount : + 41,10 EUR  
 -----

Structured Creditor Reference : **\*\*\*080/8723/01868\*\*\***

Payment 2

Account counterparty : **732-0008004-04**  
 Counterparty Name : **THIRY FRANCOISE**  
 Counterparty Address : **67 CHEMIN DE LA GUENETTE**  
 Locality counterparty : **1400 NIVELLES**

-----  
 Net Amount : + 18,30 EUR  
 -----

Structured Creditor Reference : **\*\*\*080/7626/71458\*\*\***

Payment 3

Account counterparty : **BE38 0630 4766 9572**  
 BIC bank counterparty : **GKCCBEBB**  
 Counterparty Name : **VANTIELEN ROGER**  
 Counterparty Address : **54 RUE DE SOTRIAMONT**  
 Locality counterparty : **1400 NIVELLES**

-----  
 Net Amount : + 1,75 EUR  
 -----

Structured Creditor Reference : **\*\*\*080/8620/98680\*\*\***

A	B	A = Example-Index	B = MX.CAMT053.001.02-Index
9.1	2.76	<Ntry>	
9.2	2.78	<Amt Ccy="EUR">61.15</Amt>	
9.3	2.79	<CdtDbtInd>CRDT</CdtDbtInd>	
9.4	2.81	<Sts>BOOK</Sts>	
9.5	2.82	<BookgDt>	
9.6	4.1.0	<Dt>20081020</Dt>	
9.7		</BookgDt>	
9.8	2.83	<ValDt>	
9.9	4.1.0	<Dt>20081020</Dt>	
9.10		</ValDt>	
9.11	2.84	<AcctSvcrRef>Bank Reference</AcctSvcrRef>	
9.12	2.91	<BkTxCd>	
9.13	2.92	<Domn>	
9.14	2.93	<Cd>PMNT</Cd>	
9.15	2.94	<Fmly>	
9.16	2.95	<Cd>RCDT</Cd>	
9.17	2.96	<SubFmlyCd>OTHR</SubFmlyCd>	

A	B	A = Example-Index	B = MX.CAMT053.001.02-Index
9.18			</Fmly>
9.19			</Domn>
9.20	2.97		<Prtry>
9.21	2.98		<Cd> <b>0150000</b> </Cd>
9.22	2.99		<Issr> <b>BBA</b> </Issr>
9.23			</Prtry>
9.24			</BkTxCd>
9.25	2.135		<NtryDtls>
9.26	2.136		<Btch>
9.27	2.139		<NbOfTxs> <b>3</b> </NbOfTxs>
9.28	2.140		<TtlAmt Ccy="EUR"> <b>61.15</b> </TtlAmt>
9.29	2.141		<CdtDbtInd> <b>CRDT</b> </CdtDbtInd>
9.30			</Btch>
9.31	2.142		<TxDtls>
9.32	2.143		<Refs>
9.33	2.145		<AcctSvcrRef> <b>Bank Reference</b> </AcctSvcrRef>
9.34			</Refs>
9.35	2.156		<AmtDtls>
9.36	2.1.9		<TxAmt>
9.37	2.1.10		<Amt Ccy="EUR"> <b>41.10</b> </Amt>
9.38			</TxAmt>
9.39			</AmtDtls>
9.40	2.163		<BkTxCd>
9.41	2.164		<Domn>
9.42	2.165		<Cd> <b>PMNT</b> </Cd>
9.43	2.166		<Fmly>
9.44	2.167		<Cd> <b>RCDT</b> </Cd>
9.45	2.168		<SubFmlyCd> <b>ESCT</b> </SubFmlyCd>
9.46			</Fmly>
9.47			</Domn>
9.48	2.169		<Prtry>
9.49	2.170		<Cd> <b>0150000</b> </Cd>
9.50	2.171		<Issr> <b>BBA</b> </Issr>
9.51			</Prtry>
9.52			</BkTxCd>
9.53	2.199		<RltdPties>
9.54	2.201		<Dbtr>
9.55	9.1.0		<Nm> <b>HAYETTE CHRISTOPHE</b> </Nm>
9.56	9.1.1		<PstlAdr>
9.57	9.1.11		<AdrLine> <b>PLACE DE WISBECQ 20 1430 REBECQ BE</b> </AdrLine>
9.58			</PstlAdr>
9.59			</Dbtr>
9.60	2.202		<DbtrAcct>
9.61	1.1.0		<Id>
9.62	1.1.1		<IBAN> <b>BE35732016954237</b> </IBAN>
9.63			</Id>
9.64			</DbtrAcct>
9.65			</RltdPties>
9.66	2.211		<RltdAgts>
9.67	2.212		<DbtrAgt>
9.68	6.1.0		<FinInstnId>
9.69	6.1.1		<BIC> <b>CREGBEBB</b> </BIC>
9.70			</FinInstnId>
9.71			</DbtrAgt>
9.72			</RltdAgts>
9.73	2.234		<RmtInf>
9.74	8.3.1		<Strd>
9.75	8.3.21		<CdtrRefInf>
9.76	8.3.22		<Tp>
9.77	8.3.23		<CdOrPrtry>
9.78	8.3.24		<Cd> <b>SCOR</b> </Cd>
9.79			</CdOrPrtry>
9.80	8.3.26		<Issr> <b>BBA</b> </Issr>
9.81			</Tp>

A	B	A = Example-Index	B = MX.CAMT053.001.02-Index
9.82	8.3.27		<Ref> <b>080872301868</b> </Ref>
9.83			</CdrRefInf>
9.84			</Strd>
9.85			</RmtInf>
9.86			</TxDtIs>
9.87	2.142		<TxDtIs>
9.88	2.143		<Refs>
9.89	2.145		<AcctSvcrRef> <b>Bank Reference</b> </AcctSvcrRef>
9.90			</Refs>
9.91	2.156		<AmtDtIs>
9.92	2.1.9		<TxAmt>
9.93	2.1.10		<Amt Ccy="EUR"> <b>18.30</b> </Amt>
9.94			</TxAmt>
9.95			</AmtDtIs>
9.96	2.163		<BkTxCd>
9.97	2.164		<Domn>
9.98	2.165		<Cd> <b>PMNT</b> </Cd>
9.99	2.166		<Fmly>
9.100	2.167		<Cd> <b>RCDT</b> </Cd>
9.101	2.168		<SubFmlyCd> <b>DMCT</b> </SubFmlyCd>
9.102			</Fmly>
9.103			</Domn>
9.104	2.169		<Prtry>
9.105	2.170		<Cd> <b>0150000</b> </Cd>
9.106	2.171		<Issr> <b>BBA</b> </Issr>
9.107			</Prtry>
9.108			</BkTxCd>
9.109	2.199		<RltdPtIs>
9.110	2.201		<Dbtr>
9.111	9.1.0		<Nm> <b>THIRY FRANCOISE</b> </Nm>
9.112	9.1.1		<PstlAdr>
9.113	9.1.11		<AdrLine> <b>CHEMIN DE LA GUENETTE 67 1400 NIVELLES BE</b> </AdrLine>
9.114			</PstlAdr>
9.115			</Dbtr>
9.116	2.202		<DbtrAcct>
9.117	1.1.0		<Id>
9.118	1.1.1		<Othr>
9.119			<Id> <b>732000800404</b> </Id>
9.120			</Othr>
9.121			</Id>
9.122			</DbtrAcct>
9.123			</RltdPtIs>
9.124	2.234		<RmtInf>
9.125	2.236		<Strd>
9.126	2.256		<CdrRefInf>
9.127	2.257		<Tp>
9.128	2.258		<CdOrPrtry>
9.129	2.259		<Cd> <b>SCOR</b> </Cd>
9.130			</CdOrPrtry>
9.131	2.261		<Issr> <b>BBA</b> </Issr>
9.132			</Tp>
9.133	2.262		<Ref> <b>080762671458</b> </Ref>
9.134			</CdrRefInf>
9.135			</Strd>
9.136			</RmtInf>
9.137			</TxDtIs>
9.138	2.142		<TxDtIs>
9.139	2.143		<Refs>
9.140	2.145		<AcctSvcrRef> <b>Bank Reference</b> </AcctSvcrRef>
9.141			</Refs>
9.142	2.156		<AmtDtIs>
9.143	2.1.9		<TxAmt>
9.144	2.1.10		<Amt Ccy="EUR"> <b>1.75</b> </Amt>
9.145			</TxAmt>



A	B	A = Example-Index	B = MX.CAMT053.001.02-Index
9.146			</AmtDtIs>
9.147	2.163		<BkTxCd>
9.148	2.164		<Domn>
9.149	2.165		<Cd> <b>PMNT</b> </Cd>
9.150	2.166		<Fmly>
9.151	2.167		<Cd> <b>RCDT</b> </Cd>
9.152	2.168		<SubFmlyCd> <b>ESCT</b> </SubFmlyCd>
9.153			</Fmly>
9.154			</Domn>
9.155	2.169		<Prtry>
9.156	2.170		<Cd> <b>0150000</b> </Cd>
9.157	2.171		<Issr> <b>BBA</b> </Issr>
9.158			</Prtry>
9.159			</BkTxCd>
9.160	2.199		<RltdPties>
9.161	2.201		<Dbtr>
9.162	9.1.0		<Nm> <b>VAN TIELEN ROGER</b> </Nm>
9.163	9.1.1		<PstlAdr>
9.164	9.1.5		<AdrLine> <b>RUE DE SOTRIAMONT 54 1400 NIVELLES BE</b> </AdrLine>
9.165			</PstlAdr>
9.166			</Dbtr>
9.167	2.202		<DbtrAcct>
9.168	1.1.0		<Id>
9.169	1.1.1		<IBAN> <b>BE38063047669572</b> </IBAN>
9.170			</Id>
9.171			</DbtrAcct>
9.172			</RltdPties>
9.173	2.211		<RltdAgts>
9.174	2.212		<DbtrAgt>
9.175	6.1.0		<FinInstnId>
9.176	6.1.1		<BIC> <b>GKCCBEBB</b> </BIC>
9.177			</FinInstnId>
9.178			</DbtrAgt>
9.179			</RltdAgts>
9.180	2.234		<RmtInf>
9.181	2.236		<Strd>
9.182	2.256		<CdtrRefInf>
9.183	2.257		<Tp>
9.184	2.258		<CdOrPrtry>
9.185	2.259		<Cd> <b>SCOR</b> </Cd>
9.186			</CdOrPrtry>
9.187	2.261		<Issr> <b>BBA</b> </Issr>
9.188			</Tp>
9.189	2.262		<Ref> <b>080862098680</b> </Ref>
9.190			</CdtrRefInf>
9.191			</Strd>
9.192			</RmtInf>
9.193			</TxDtIs>
9.194			</NtryDtIs>
9.195			</Ntry>

## 7.4.8. Direct Debits (SDD)

Debits, invoices Remise - credit

Your reference :

**000001575/000000001**

Booking Date :

**07/10/2010**

Value Date

**07/10/2010**

-----  
Total net amount :

**+796,90 Eur**

### Direct debit 1

Your reference :

**000001575/000000005**

-----  
Net Amount :

**+ 232,41 EUR**

-----  
Debit number :

**BE96550300400505**

Central (pivot) Date :

**07/10/2010**

Unstructured Communication :

**057500059922**

Mandate Number :

**040953696800001207**

### Direct debit 2

Your reference :

**000001575/000000008**

-----  
Net Amount :

**+ 564,90 EUR**

-----  
Debit number :

**BE71057643353069**

Central (pivot) Date :

**07/10/2010**

Unstructured Communication :

**057500089931**

Mandate Number :

**040953696800003802**

A	B	A = Example-Index	B = MX.CAMT053.001.02-Index
10.1	2.76	<Ntry>	
10.2	2.78	<Amt Ccy="EUR"> <b>796.90</b> </Amt>	
10.3	2.79	<CdtDbtInd> <b>CRDT</b> </CdtDbtInd>	
10.4	2.81	<Sts> <b>BOOK</b> </Sts>	
10.5	2.82	<BookgDt>	
10.6	4.1.0	<Dt> <b>20101007</b> </Dt>	
10.7		</BookgDt>	
10.8	2.83	<ValDt>	
10.9	4.1.0	<Dt> <b>20101007</b> </Dt>	
10.10		</ValDt>	
10.11	2.84	<AcctSvcrRef> <b>Bank Reference</b> </AcctSvcrRef>	
10.12	2.91	<BkTxCd>	
10.13	2.92	<Domn>	
10.14	2.93	<Cd> <b>PMNT</b> </Cd>	
10.15	2.94	<Fmly>	
10.16	2.95	<Cd> <b>IDDT</b> </Cd>	
10.17	2.96	<SubFmlyCd> <b>ESDD</b> </SubFmlyCd>	
10.18		</Fmly>	
10.19		</Domn>	
10.20	2.97	<Prtry>	
10.21	2.98	<Cd> <b>0550000</b> </Cd>	
10.22	2.99	<Issr> <b>BBA</b> </Issr>	
10.23		</Prtry>	
10.24		</BkTxCd>	
10.25	2.135	<NtryDtIs>	
10.26	2.136	<Btch>	
10.27	2.138	<PmtInfId> <b>000001575/000000001</b> </PmtInfId>	
10.28	2.139	<NbOfTx> <b>4</b> </NbOfTx>	
10.29	2.140	<TtlAmt Ccy="EUR"> <b>796.90</b> </TtlAmt>	

A	B	A = Example-Index	B = MX.CAMT053.001.02-Index
10.30	2.141		<CdtDbtInd> <b>CRDT</b> </CdtDbtInd>
10.31			</Btch>
10.32	2.142		<TxDtls>
10.33	2.143		<Refs>
10.34	2.145		<AcctSvcrRef> <b>08196A7000134</b> </AcctSvcrRef>
10.35	2.148		<EndToEndId> <b>000001575/000000005</b> </ EndToEndId>
10.36	2.150		<MndtId> <b>040953696800001207</b> </MndtId>
10.37			</Refs>
10.38	2.156		<AmtDtls>
10.39	2.1.9		<TxAmt>
10.40	2.1.10		<Amt Ccy="EUR"> <b>232.41</b> </Amt>
10.41			</TxAmt>
10.42			</AmtDtls>
10.43	2.199		<RltdPties>
10.44	2.204		<Cdtr>
10.45	9.1.0		<Nm> <b>ISOBLABLA</b> </Nm>
10.46			</Cdtr>
10.47	2.205		<CdtrAcct>
10.48	1.1.0		<Id>
10.49	1.1.1		<IBAN> <b>BE9655030040050</b> </IBAN>
10.50			</Id>
10.51			</CdtrAcct>
10.52			</RltdPties>
10.53	2.211		<RltdAgts>
10.54	2.213		<CdtrAgt>
10.55	6.1.0		<FinInstnId>
10.56	6.1.1		<BIC> <b>GKCCBEBB</b> </BIC>
10.57			</FinInstnId>
10.58			</CdtrAgt>
10.59			</RltdAgts>
10.60	2.234		<RmtInf>
10.61	2.235		<Ustrd> <b>057500059922</b> </Strd>
10.62			</RmtInf>
10.63	2.266		<RltdDts>
10.64	2.267		<AcctncDtTm> <b>20101007T00:00:00</b> </AcctncDtTm>
10.65			</RltdDts>
10.66			</TxDtls>
10.67	2.142		<TxDtls>
10.68	2.143		<Refs>
10.69	2.145		<AcctSvcrRef> <b>08196A7000134</b> </AcctSvcrRef>
10.70	2.148		<EndToEndId> <b>000001575/000000008</b> </ EndToEndId>
10.71	2.150		<MndtId> <b>040953696800003802</b> </MndtId>
10.72			</Refs>
10.73	2.156		<AmtDtls>
10.74	2.1.9		<TxAmt>
10.75	2.1.10		<Amt Ccy="EUR"> <b>564.49</b> </Amt>
10.76			</TxAmt>
10.77			</AmtDtls>
10.78	2.199		<RltdPties>
10.79	2.204		<Cdtr>
10.80	9.1.0		<Nm> <b>IMPERMET NV</b> </Nm>
10.81			</Cdtr>
10.82	2.205		<CdtrAcct>
10.83	1.1.0		<Id>
10.84	1.1.1		<IBAN> <b>BE71057643353069</b> </IBAN>
10.85			</Id>
10.86			</CdtrAcct>
10.87			</RltdPties>
10.88	2.211		<RltdAgts>
10.89	2.213		<CdtrAgt>
10.90	6.1.0		<FinInstnId>
10.91	6.1.1		<BIC> <b>GKCCBEBB</b> </BIC>
10.92			</FinInstnId>
10.93			</CdtrAgt>
10.94			</RltdAgts>

A	B	A = Example-Index	B = MX.CAMT053.001.02-Index
10.95	2.234		<RmtInf>
10.96	2.235		<Ustrd> <b>057500089931</b> </Strd>
10.97			</RmtInf>
10.98	2.266		<RltdDts>
10.99	2.267		<AcctncDtTm> <b>20101007T00:00:00</b> </AcctncDtTm>
10.100			</RltdDts>
10.101			</TxDtIs>

### 7.4.9. Unpaid Direct Debits (SDD)

Booking Date : **08/10/10**  
Value Date : **07/10/10**  
Your reference : **1000003408**

-----  
Total net amount : **- 4,87 EUR**  
-----

#### Unpaid direct debit 1

Your reference : **0000337349**

-----  
Net Amount : **- 4,87 EUR**  
-----

Central (pivot) Date : **07/10/2010**  
Communication : **/INV/00900509007724**  
Reason for denial : **Other reason**  
Mandate Number : **300107**

A	B	A = Example-Index	B = MX.CAMT053.001.02-Index
11.1	2.76		<Ntry>
11.2	2.78		<Amt Ccy="EUR"> <b>4.87</b> </Amt>
11.3	2.79		<CdtDbtInd> <b>DBIT</b> </CdtDbtInd>
11.4	2.80		<RvslInd> <b>TRUE</b> </RvslInd>
11.5	2.81		<Sts> <b>BOOK</b> </Sts>
11.6	2.82		<BookgDt>
11.7	4.1.0		<Dt> <b>20101008</b> </Dt>
11.8			</BookgDt>
11.9	2.83		<ValDt>
11.10	4.1.0		<Dt> <b>20101007</b> </Dt>
11.11			</ValDt>
11.12	2.84		<AcctSvcrRef> <b>08196A7000274</b> </AcctSvcrRef>
11.13	2.91		<BkTxCd>
11.14	2.92		<Domn>
11.15	2.93		<Cd> <b>PMNT</b> </Cd>
11.16	2.94		<Fmly>
11.17	2.95		<Cd> <b>IDDT</b> </Cd>
11.18	2.96		<SubFmlyCd> <b>ESDD</b> </SubFmlyCd>
11.19			</Fmly>
11.20			</Domn>
11.21	2.97		<Prtry>
11.22	2.98		<Cd> <b>0503000</b> </Cd>
11.23	2.99		<Issr> <b>BBA</b> </Issr>
11.24			</Prtry>
11.25			</BkTxCd>
11.26	2.135		<NtryDtIs>
11.27	2.136		<Btch>
11.28	2.138		<PmtInfId> <b>1000003408</b> </PmtInfId>
11.29	2.139		<NbOfTx> <b>1</b> </NbOfTx>
11.30	2.140		<TtlAmt Ccy="EUR"> <b>4.87</b> </TtlAmt>
11.31	2.141		<CdtDbtInd> <b>DBIT</b> </CdtDbtInd>
11.32			</Btch>
11.33	2.142		<TxDtIs>

A	B	A = Example-Index	B = MX.CAMT053.001.02-Index
11.34	2.143		<Refs>
11.35	2.145		<AcctSvcrRef> <b>08196A7000274</b> </AcctSvcrRef>
11.36	2.148		<EndToEndId> <b>0000337349</b> </EndToEndId>
11.37	2.150		<MndtId> <b>300107</b> </MndtId>
11.38			</Refs>
11.39	2.156		<AmtDtls>
11.40	2.1.9		<TxAmt>
11.41	2.1.10		<Amt Ccy="EUR"> <b>4.87</b> </Amt>
11.42			</TxAmt>
11.43			</AmtDtls>
11.44	2.199		<RltdPties>
11.45	2.204		<Cdtr>
11.46	9.1.0		<Nm> <b>SACHA TOUILLE</b> </Nm>
11.47			</Cdtr>
11.48	2.205		<CdtrAcct>
11.49	1.1.0		<Id>
11.50	1.1.1		<IBAN> <b>BE37210058430428</b> </IBAN>
11.51			</Cdtr>
11.52			</RltdPties>
11.53	2.211		<RltdAgts>
11.54	2.213		<CdtrAgt>
11.55	6.1.0		<FinInstnId>
11.56	6.1.1		<BIC> <b>GEBABEBB</b> </BIC>
11.57			</FinInstnId>
11.58			</CdtrAgt>
11.59			</RltdAgts>
11.60	2.234		<RmtInf>
11.61	2.235		<Ustrd> <b>/INV/00900509007724</b> </Ustrd>
11.62			</RmtInf>
11.63	2.266		<RltdDts>
11.64	2.267		<AcptncDtTm> <b>20101007T00:00:00</b> </AcptncDtTm>
11.65	2.273		<TxDtTm> <b>20100106T00:00:00</b> </TxDtTm>
11.66			</RltdDts>
11.67	2.293		<RtrInf>
11.68	2.304		<Rsn>
11.69	2.305		<Cd> <b>MS03</b> </Cd>
11.70			</Rsn>
11.71			</RtrInf>
11.72			</TxDtls>

## 7.4.10. Taxes on charges

Booking Date :	<b>24/09/2010</b>
Value Date :	<b>24/09/2010</b>
Net Amount :	<b>- 1539,93 EUR</b>
-----	
Gross Amount :	<b>- 1500,00 EUR</b>
-----	
Communication :	<b>INBEMEC 9 13</b>
-----	
Correspondence charges :	<b>- 20,00 EUR</b>
-----	
Miscellaneous commisions :	<b>- 5,00 EUR</b>
-----	
Transfer commision :	<b>- 8,00 EUR</b>
-----	
VAT :	<b>- 6,93 EUR</b>
-----	
Amount on which percentage was calculated :	<b>33,00 EUR</b>
Percent :	<b>21 %</b>

A	B	A = Example-Index B = MX.CAMT053.001.02-Index
12.1	2.76	<Ntry>
12.2	2.78	<Amt Ccy="EUR"> <b>1539.93</b> </Amt>
12.3	2.79	<CdtDbtInd> <b>CRDT</b> </CdtDbtInd>
12.4	2.81	<Sts> <b>BOOK</b> </Sts>
12.5	2.82	<BookgDt>
12.6	4.1.0	<Dt> <b>20100924</b> </Dt>
12.7		</BookgDt>
12.8	2.83	<ValDt>
12.9	4.1.0	<Dt> <b>20100924</b> </Dt>
12.10		</ValDt>
12.11	2.84	<AcctSvcrRef> <b>Bank Reserve</b> </AcctSvcrRef>
12.12	2.91	<BkTxCd>
12.13	2.92	<Domn>
12.14	2.93	<Cd> <b>PMNT</b> </Cd>
12.15	2.94	<Fmly>
12.16	2.95	<Cd> <b>ICDT</b> </Cd>
12.17	2.96	<SubFmlyCd> <b>XBCT</b> </SubFmlyCd>
12.18		</Fmly>
12.19		</Domn>
12.20	2.97	<Prtry>
12.21	2.98	<Cd> <b>4101000</b> </Cd>
12.22	2.99	<Issr> <b>BBA</b> </Issr>
12.23		</Prtry>
12.24		</BkTxCd>
12.25	2.135	<NtryDtls>
12.26	2.142	<TxDtls>
12.27	2.156	<AmtDtls>
12.28		<InstdAmt>
12.29		<Amt Ccy="EUR"> <b>1500.00</b> </Amt>
12.30		</InstdAmt>
12.31		<AmtDtls>
12.32	2.172	<Chrgs>
12.33	2.174	<Amt Ccy="EUR"> <b>20.00</b> </Amt>
12.34	2.175	<CdtDbtInd> <b>DBIT</b> </CdtDbtInd>
12.35	2.176	<Tp>
12.36	2.178	<Prtry>
12.37	7.1.0	<Id> <b>015</b> </Id>
12.38	7.1.1	<Issr> <b>BBA</b> </Issr>
12.39		</Prtry>

A	B	A = Example-Index	B = MX.CAMT053.001.02-Index
12.40			</Tp>
12.41			</Chrgs>
12.42	2.172		<Chrgs>
12.43	2.174		<Amt Ccy="EUR"> <b>5,00</b> </Amt>
12.44	2.175		<CdtDbtInd> <b>DBIT</b> </CdtDbtInd>
12.45	2.176		<Tp>
12.46	2.178		<Prtry>
12.47	7.1.0		<Id> <b>006</b> </Id>
12.48	7.1.1		<Issr> <b>BBA</b> </Issr>
12.49			</Prtry>
12.50			</Tp>
12.51			</Chrgs>
12.52	2.172		<Chrgs>
12.53	2.174		<Amt Ccy="EUR"> <b>8,00</b> </Amt>
12.54	2.175		<CdtDbtInd> <b>DBIT</b> </CdtDbtInd>
12.55	2.176		<Tp>
12.56	2.178		<Prtry>
12.57	7.1.0		<Id> <b>209</b> </Id>
12.58	7.1.1		<Issr> <b>BBA</b> </Issr>
12.59			</Prtry>
12.60			</Tp>
12.61			</Chrgs>
12.62	2.292		<Tax>
12.63	13.1.15		<TtlTaxAmt Ccy="EUR"> <b>6.93</b> </TtlTaxAmt>
12.64	13.1.18		<Rcrd>
12.65	13.1.19		<Tp> <b>011</b> </Tp>
12.66	13.1.31		<TaxAmt>
12.67	13.1.32		<Rate> <b>0.21</b> </Rate>
12.68	13.1.33		<TaxblAmt Ccy="EUR"> <b>33.00</b> </TaxblAmt>
12.69	13.1.34		<TtlAmt Ccy="EUR"> <b>6.93</b> </TtlAmt>
12.70			</TaxAmt>
12.71			</Rcrd>
12.72			</Tax>
12.73			</TxDtIs>
12.74			</NtryDtIs>
12.75			</Ntry>

## 8. Document version changes

### 8.1. Version 2.0 – 03/03/2015

Changes with regard to the previous document version 1.0 are listed here:

- Chapter 1 point 4 – Restriction to the Latin character set has been removed
- Addition of the description of tags ID for the UltimateDebtor and UltimateCreditor, both in the overview and in the details
- XSD scheme location removed from the header example in chapter 7; part 7.1
- 2.26 balance types: ITBD (interim booked) removed from the table of possible values since this is a type only used in intraday statements
- 2.29 balance subtypes: addition of INTM (intermediate) with description as a possible value
- 2.153: addition of the block Proprietary within References
- 2.273: addition of the tag TransactionDateTime

### 8.2. Version 2.1 – 27/11/2018

Changes with regard to the previous document version 2.0 are listed here:

- Addition of family 02: Instant SEPA Credit Transfers in Appendix 6.1





[www.febelfin.be](http://www.febelfin.be)



**Belgian Financial sector Federation**

Rue d'Arlon/Aarlenstraat 82 | 1040 Brussels

T 02 507 68 11 | [info@febelfin.be](mailto:info@febelfin.be) | [www.febelfin.be](http://www.febelfin.be)